

Digital Photogrammetry

Wilfried Linder

Digital Photogrammetry

A Practical Course

 Springer

PD Dr. Dr. -Ing. Wilfried Linder
Universität Düsseldorf
Geographisches Institut
Universitätsstr. 1
40225 Düsseldorf
Germany
wilfried.linder@uni-duesseldorf.de

ISBN: 978-3-540-92724-2

e-ISBN: 978-3-540-92725-9

DOI 10.1007/978-3-540-92725-9

Library of Congress Control Number: 2008942060

© Springer-Verlag Berlin Heidelberg 2009

This work is subject to copyright. All rights are reserved, whether the whole or part of the material is concerned, specifically the rights of translation, reprinting, reuse of illustrations, recitation, broadcasting, reproduction on microfilm or in any other way, and storage in data banks. Duplication of this publication or parts thereof is permitted only under the provisions of the German Copyright Law of September 9, 1965, in its current version, and permission for use must always be obtained from Springer. Violations are liable to prosecution under the German Copyright Law.

The use of general descriptive names, registered names, trademarks, etc. in this publication does not imply, even in the absence of a specific statement, that such names are exempt from the relevant protective laws and regulations and therefore free for general use.

Cover design: WMX Design GmbH, Heidelberg

Printed on acid-free paper

9 8 7 6 5 4 3 2 1

springer.com

Preface 1st edition

Photogrammetry is a science based technology with more than a century of history and development. During this time, the techniques used to get information about objects represented in photos have changed dramatically from pure optic-mechanical equipment to a fully digital workflow in our days. Parallel to this, the handling became easier, and so its possible also for non-photogrammetrists to use these methods today.

This book is especially written for potential users which have no photogrammetric education but would like to use the powerful capabilities from time to time or in smaller projects: Geographers, Geologists, Cartographers, Forest Engineers who would like to come into the fascinating field of photogrammetry via “learning by doing”. For this reason, this book is not a textbook – for more and deeper theory, there exists a lot of literature, and it is suggested to use some of this. A special recommendation should be given to the newest book from KONECNY (2002) for basic theory and the mathematical backgrounds or to the book from SCHENK (1999) for the particular situation in digital photogrammetry. For a quick reference especially to algorithms and technical terms see also the Photogrammetric Guide from ALBERTZ & WIGGENHAGEN (2005).

This book includes a CD-ROM which contains all you need from software and data to learn about the various methods from the beginning (scanning of the photos) to final products like ortho images or mosaics. Starting with some introductory chapters and a little bit of theory, you can go on step by step in several tutorials to get an idea how photogrammetry works. The software is not limited to the example data which we will use here – it offers you a small but powerful Digital Photogrammetric Workstation (DPW), and of course you may use it for your own projects.

Some words about the didactic principle used in this book. In Germany, we have an old and very famous movie, “Die Feuerzangenbowle” with Heinz Rühmann. This actor goes to school, and the teacher of physics explains a steam engine:

“Wat is en Dampfmaschin? Da stelle mer us janz dumm, un dann sage mer so: En Dampfmaschin, dat is ene große, schwachze Raum...” (SPOERL, 1933. A language similar to German, spoken in the area of Cologne; in English: What is a steam engine? Suppose we have really no idea, and then let’s say: A steam engine,

that is a big black hole...). This “suppose we have no idea” will lead us through the book – therefore let’s enter the big black hole called photogrammetry, let’s look around and see what happens, just learning by doing. Theoretical background will only be given if it is indispensable for the understanding, but don’t worry, it will be more than enough of theory for the beginning!

Concerning the object(s) of interest and the camera position(s), we distinguish between terrestrial (close-range) and aerial photogrammetry. This book mostly deals with the aerial case. Nevertheless, the mathematical and technical principles are similar in both cases, and we will see an example of close-range photogrammetry in the last tutorial.

A briefly description of the software is included in the last part of this book (chapter 7).

This is the right place to give thanks to all people who helped me:

To my chief, Prof. Dr. Ekkehard Jordan, for all the time he gave me to write this book, and for his interest in this science – he was one of the first Geographers using analytical photogrammetric methods in glacier investigation – and to all my friends and colleagues from the Geographic Institute, University of Düsseldorf, for many discussions and tests. To Mrs. Angela Rennwanz from the same institute – she made the final layout, therefore my special thanks to her!

To Prof. Dr. mult. Gottfried Konecny, who encouraged, helped and forced me many times and gave me a lot of ideas, and to all my friends and colleagues from the Institute of Photogrammetry and GeoInformation (IPI), University of Hannover, for their scientific help and patience – especially to my friend Dr.-Ing. Karsten Jacobsen. To Prof. Dr.-Ing. Christian Heipke, now chief of the IPI, who agreed that I could use all of the infrastructure in this institute, and for several very interesting discussions especially concerning image matching techniques.

For proof-reading of this book thanks (in alphabetical order) to Dr. Jörg Elbers, Glenn West and Prof. Dr. mult. Gottfried Konecny.

Un agradecimiento de corazón a mis amigos del America del Sur, especialmente en Bolivia y Colombia!

It may be of interest for you: All figures in this book are also stored on the CD-ROM (directory ...figures) as MS PowerPoint™ files. Whenever you would like to use some of them, may be for education or scientific texts, please refer to this book! Thanks to the publishers for this agreement.

Preface 2nd edition

During the short time between the first edition and now many things happen giving the editors and me the idea not only to actualise this book but also to include further chapters. The changes are (among others):

The subtitle. It was the goal to give readers a compact and practical course with theoretical background only as far as necessary. Therefore we changed the subtitle from “Theory and Applications” to “A practical course”. Nevertheless, and this was a remark of several reviewers, some more theory than before is included.

More about close-range photogrammetry. The first edition dealt mainly with aerial photogrammetry, now the field of terrestrial or close-range applications is expanded. For instance, an automatic handling of image sequences (time series) was developed and will be presented.

In this context we also take a special look to digital consumer cameras which now are available for low prices and which the reader may use for own projects in close-range applications. Regarding the lens distortion of such cameras, a chapter dealing with lens calibration was added.

A glossary now gives the reader a quick reference to the most important terms of photogrammetry. All words or technical terms included there are written in *italics* in this book.

Last but not least: The software which you find on the CD-ROM was improved and expanded, and the installation of software and data is now easier than before.

Bad Pyrmont, July 2005

Wilfried Linder

Preface 3rd edition

Also the second edition was sold successful. It seems that the hope I wrote about in chapter 6.8 (“A view into the future: Photogrammetry in 2020”) will be fulfilled – photogrammetric techniques are not only in use until today but even new fields of applications came up. One of them is stereo photogrammetry with high resolution satellite images about which we will talk and learn in a new tutorial, see chapter 6.6. Another interesting new chapter (6.7) deals with simple flatbed scanners which you can use to create anaglyph images from small objects.

Again the software (included on the CD-ROM) was improved, a new programme (LISA FFSAT) was added, and the text in this book was actualised to the new possibilities of the software.

This is the place to thank the publisher and in particular Dr. Christian Witschel for the pleasant and straightforward collaboration since nearly 10 years!

Düsseldorf, January 2009

Wilfried Linder

Contents

- 1 Introduction.....1**
 - 1.1 Basic idea and main task of photogrammetry 1
 - 1.2 Why photogrammetry ?3
 - 1.3 Image sources: Analogue and digital cameras4
 - 1.4 Digital consumer cameras6
 - 1.5 Short history of photogrammetric evaluation methods7
 - 1.6 Geometric principles 1: Camera position, focal length8
 - 1.7 Geometric principles 2: Image orientation 11
 - 1.8 Geometric principles 3: Relative camera positions (stereo)..... 13
 - 1.9 Some definitions 15
 - 1.10 Length and angle units 16
 - 1.11 A typical workflow in photogrammetry 16
- 2 Included software and data19**
 - 2.1 Hardware requirements, operating system 19
 - 2.2 Image material20
 - 2.3 Overview of the software20
 - 2.4 Installation.....22
 - 2.5 Additional programmes, copyright, data23
 - 2.6 General remarks23
 - 2.7 Software versions, support24
- 3 Scanning of photos27**
 - 3.1 Scanner types27
 - 3.2 Geometric resolution28
 - 3.3 Radiometric resolution29
 - 3.4 Some practical advice29
 - 3.5 Import of the scanned images 31
- 4 Example 1: A single model33**
 - 4.1 Project definition 33
 - 4.2 Orientation of the images35
 - 4.2.1 Camera definition35
 - 4.2.2 Interior orientation37
 - 4.2.3 Brightness and contrast39
 - 4.2.4 Control points40

4.2.5	Exterior orientation	43
4.2.6	Over-determination and error detection.....	47
4.3	Model definition	48
4.4	Stereoscopic viewing	51
4.5	Measurement of object co-ordinates	52
4.6	Creation of DTMs via image matching.....	55
4.6.1	Some theory.....	55
4.6.2	Practical tests	60
4.6.3	Additional manual measurements.....	63
4.6.4	Quality control.....	64
4.7	Ortho images.....	65
4.7.1	Some theory.....	66
4.7.2	Resampling methods	67
4.7.3	Practical tests	69
4.7.4	Creation and overlay of contours.....	70
4.7.5	Simple 3D data collection	72
5	Example 2: Aerial triangulation	75
5.1	Aerial triangulation measurement (ATM)	75
5.1.1	Common principles	75
5.1.2	Interior orientation.....	78
5.1.3	Manual measurement	78
5.1.4	Automatic measurement via image matching: Introduction	82
5.1.5	Co-ordinate input and measurement of ground control points.....	82
5.1.6	Strip definition.....	85
5.1.7	Measurement of strip connections	86
5.1.8	Automatic image co-ordinate measurement (AATM).....	87
5.2	Block adjustment with BLUH	91
5.2.1	Introduction	91
5.2.2	Running the block adjustment	92
5.2.3	Discussion of the results.....	94
5.2.4	Additional analysis of the results	99
5.2.5	Block adjustment with other programmes: Example BINGO	104
5.3	Mosaics of DTMs and ortho images	105
5.3.1	Model definition	105
5.3.2	Creation of a DTM mosaic.....	105
5.3.3	Creation of an ortho image mosaic	106
5.3.4	Shaded relief.....	108
5.3.5	Contour lines overlay	108
5.3.6	3D view	109
5.3.7	3D view in real-time: Example for plug-ins	109
6	Example 3: Some special cases.....	111
6.1	Scanning aerial photos with an A4 scanner	111
6.2	Interior orientation without camera parameters	113
6.3	Images from a digital camera.....	114

6.3.1	The situation	114
6.3.2	Interior and exterior orientation	116
6.3.3	Geometric problems	117
6.3.4	DTM creation	119
6.3.5	Differential DTM.....	120
6.4	An example of close-range photogrammetry	121
6.4.1	The situation	121
6.4.2	Interior and exterior orientation	123
6.4.3	Model definition	127
6.4.4	DTM creation	127
6.4.5	Image sequences.....	129
6.4.6	Visualisation of wave movement.....	130
6.5	Some remarks about lens distortion	132
6.6	Stereo images from satellites	134
6.7	Stereo images from flatbed scanners.....	137
6.8	A view into the future: Photogrammetry in 2020.....	139
7	Programme description	141
7.1	Some definitions	141
7.2	Basic functions.....	141
7.3	Aims and limits of the programme.....	142
7.4	Operating the programme	142
7.5	Buttons in the graphics windows	143
7.6	File handling	144
7.6.1	File > Select project.....	144
7.6.2	File > Define project.....	144
7.6.3	File > Edit project.....	145
7.6.4	File > Import raster.....	145
7.6.5	File > Import Rollei CDW	145
7.6.6	File > Combination.....	145
7.6.7	File > Reference list.....	146
7.6.8	File > Numerical file names	146
7.7	Pre programmes	147
7.7.1	Pre programmes > Camera definition > Analogue.....	147
7.7.2	Pre programmes > Camera definition > Digital	148
7.7.3	Pre programmes > Control point editor	149
7.7.4	Pre programmes > Strip definition.....	149
7.7.5	Pre programmes > Orientation > Measure > Interior orientation.....	150
7.7.6	Pre programmes > Orientation > Measure > Exterior orientation.....	152
7.7.7	Pre programmes > Orientation > Measure > Pseudo camera def.....	154
7.7.8	Pre programmes > Orientation > Measure > LICAL	154
7.7.9	Pre programmes > Parameters of the exterior orient. > Manual	155

7.7.10	Pre programmes > Parameters of the exterior orient. > Import	155
7.7.11	Pre programmes > Parameters of the exterior orient. > BINGO	155
7.7.12	Pre programmes > Select model	155
7.7.13	Pre programmes > Define model	156
7.8	Aerial triangulation measurement (ATM)	159
7.8.1	ATM > Manual measurement	159
7.8.2	ATM > Editor ATM points	163
7.8.3	ATM > Calculate strip images	163
7.8.4	ATM > Measure connections	163
7.8.5	ATM > Automatic measurement (AATM)	165
7.8.6	ATM > Import > IMATIE	166
7.8.7	ATM > Export > BLUH	166
7.8.8	ATM > Export > BINGO	167
7.8.9	ATM > Export > IMATIE	167
7.8.10	ATM > BLUH graphics	167
7.9	Processing	168
7.9.1	Processing > Stereo measurement	168
7.9.3	Processing > Stereo correlation (matching)	170
7.9.4	Processing > DTM interpolation	173
7.9.5	Processing > Compare nominal - real	173
7.9.6	Processing > Ortho image	174
7.9.7	Processing > Image sequence	175
7.10	Display	176
7.10.1	Display raster image	176
7.10.2	Display text	177
7.11	Aerial triangulation with BLUH	178
7.11.1	Getting started	178
7.11.2	Pre processing	178
7.11.3	Pre processing > Import PIX	178
7.11.4	Block adjustment > Strategy	179
7.11.5	Block adjustment > The central BLUH modules	179
7.11.6	Block adjustment > All (batch)	180
7.11.7	Block adjustment > Export orientations	180
7.11.8	Post processing > Analysis (BLAN)	180
7.11.9	Post processing > Display graphics	180
7.11.10	Some more theory	180
Appendix		185
1.	Codes	185
2.	GCP positions for tutorial 2	185
3.	Technical data of digital camera chips	204
References		205
Glossary		209

List of figures and formulas.....213
 1. Figures213
 2. Formulas215
Index217

1 Introduction

1.1

Basic idea and main task of photogrammetry

If you want to measure the size of an object, let's say the length, width and height of a house, then normally you will carry this out directly at the object. Now imagine that the house didn't exist anymore – it was destroyed, but some historic photos exist. Then, if you can determine the scale of the photos, it must be possible to get the desired data.

Of course you can use photos to get information about objects. This kind of information is different: So, for example, you may receive *qualitative data* (the house seems to be old, the walls are coloured light yellow) from photo interpretation, or *quantitative data* like mentioned before (the house has a base size of 8 by 6 meters) from photo measurement, or information in addition to your background knowledge (the house has elements of the “art nouveau” style, so may be constructed at the beginning of the 20th century), and so on.

Photogrammetry provides methods to give you information of the second type, quantitative data. As the term already indicates, photogrammetry can be defined as the “science of measuring in photos”, and is traditional a part of geodesy, belonging to the field of remote sensing (RS). If you would like to determine distances, areas or anything else, the basic task is to get object (terrain) co-ordinates of any point in the photo from which you can then calculate geometric data or create maps.

Obviously, from a single photo (two-dimensional plane) you can only get two-dimensional co-ordinates. Therefore, if we need three-dimensional co-ordinates, we have to find a way how to get the third dimension. This is a good moment to remember the properties of human vision (see also chapter 4.4). We are able to see objects in a spatial manner, and with this we are able to estimate the distance between an object and us. But how does it work? As you know, our brain at all times gets two slightly different images resulting from the different positions of the left respectively the right eye and according to the fact of the eye's central perspective.

Exactly this principle, the so-called *stereoscopic viewing*, is used to get three-dimensional information in photogrammetry: If we have two (or more) photos from the same object but taken from different positions, we may easily calculate the three-dimensional co-ordinates of any point which is represented in both photos. Therefore we can define the main task of photogrammetry in the following way: For any object point represented in at least two photos we have to calculate the three-dimensional object (terrain) co-ordinates. This seems to be easy, but as you will see in the chapters of this book, it needs some work to reach this goal...

For the first figure, let's use the situation of aerial photogrammetry. To illustrate what we have said before, please take a look at figure 1:

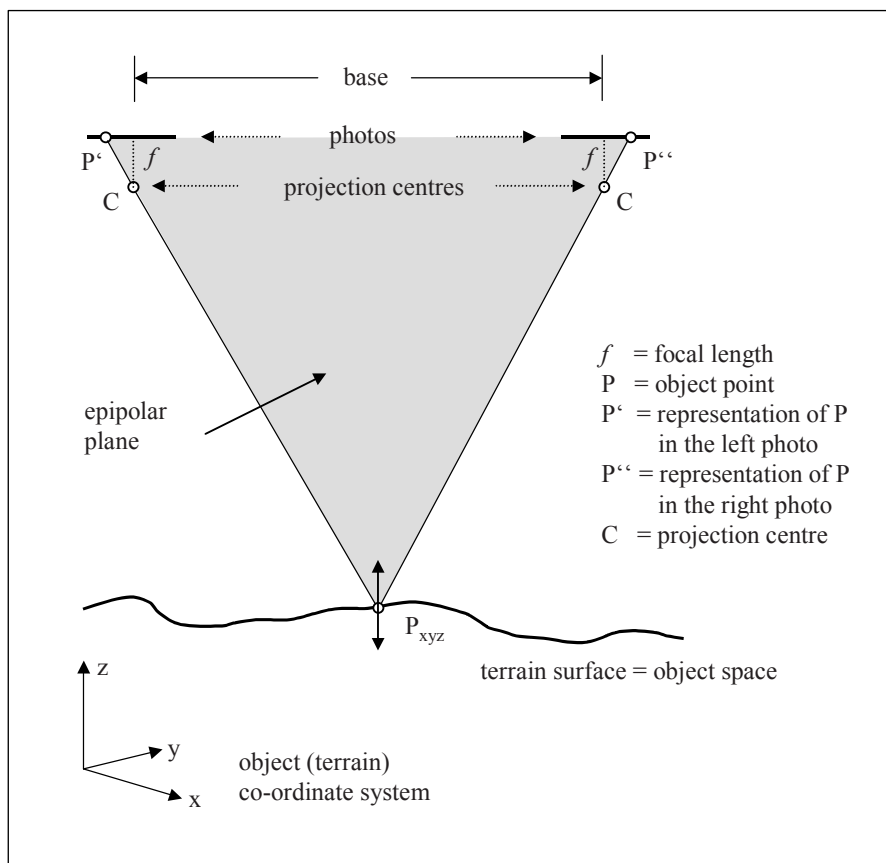

Fig. 1: Geometry in an oriented stereo model. Changing the height in point P (on the surface) leads to a linear motion (left – right) of the points P' and P'' within the photos along *epipolar lines*.

Each point on the terrain surface (object point) is represented in at least two photos. If we know or if we are able to reconstruct all geometric parameters of the situation when taking the photos, then we can calculate the three-dimensional coordinates (x, y, z) of the point P by setting up the equations of the rays $[P' \rightarrow P]$ and $[P'' \rightarrow P]$ and after that calculating their intersection. This is the main task of photogrammetry as you remember, and you can easily imagine that, *if* we have reached this, we are able to digitise points, lines and areas for map production or calculate distances, areas, volumes, slopes and much more.

1.2 Why photogrammetry ?

There are many situations in life or science in which we must measure co-ordinates, distances, areas or volumes. Normally we will use tools like a ruler or a foot rule. This is the place to discuss situations in which photogrammetric techniques may be used as an alternative or in which photogrammetry is the only possible way to measure:

In many cases the methods of measurement depend on the kind of the objects. As already mentioned in chapter 1.1 it may happen that the object itself doesn't exist any more but only photos from the object. Similar to this are situations in which the object cannot be reached. For instance, imagine areas far away or in countries without adequate infrastructure, which then can be photographed to create maps.

Measure in photos means also measure without a physical contact to the object. Therefore, if you have very smooth objects like liquids, sand or clouds, photogrammetry will be the tool of choice.

Further, all kind of fast moving objects will be measured with photogrammetry. For instance these may be running or flying animals or waves. In industry, high-speed cameras with simultaneous activation are used to get data about deformation processes (like crash tests with cars).

In some examples, nowadays laser scanner equipment is an alternative to photogrammetry. In the aerial case laser scanning is used to get information about the relief (terrain models), but also in the close-range case these techniques are widely spread especially if it is necessary to get large amounts of three-dimensional point data (point clouds). The advantage here is that the object can be low textured – a situation where photogrammetric matching techniques (chapter 4.6) often fail. On the other hand, laser scanning is time consuming and up to now very expensive, comparing with photogrammetric methods, and laser scanning cannot be used for fast moving objects. Therefore, these methods may be seen as a supplement to photogrammetry.

1.3

Image sources: Analogue and digital cameras

The development of photogrammetry is closely connected with that of aviation and photography. During more than 100 years, photos have been taken on glass plates or film material (negative or positive). In principle, specific photogrammetric cameras (also simply called *metric cameras*) work the same way as the amateur camera you might own. The differences result from the high quality demands which the first ones must fulfil.

Beside high precision optics and mechanics, aerial cameras use a large film format. You may know the size of 24 by 36 mm from your own camera – aerial cameras normally use a size of 230 by 230 mm (9 by 9 inch)! This is necessary to receive a good ground resolution in the photos. As a result, the values of “wide angle”, “normal” and “telephoto” focal lengths differ from those you may know – for example, the often used wide angle aerial camera has a focal length of about 153 mm, the normal one a focal length of about 305 mm.

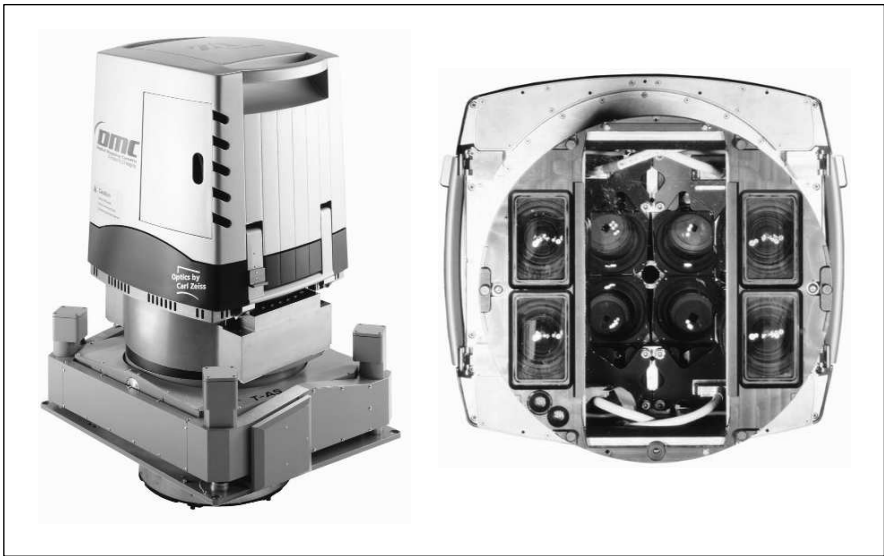

Fig 2: The DMC (Digital Mapping Camera) – an example of a digital aerial camera. Left: Camera mounted on carrier. Right: View from below – you can see the lenses belonging to the four area sensors. Courtesy of Intergraph Corp., USA.

Furthermore, the lens system of aerial cameras is constructed as a unit with the camera body. No lens change or “zoom” is possible to provide high stability and a good lens correction. The focal length is fixed, and the cameras have a central shutter.

Similar to this, also for close-range applications special cameras were developed with a medium or large film format and fixed lenses.

Since long times, manufacturers like Z/I imaging (now Intergraph Corp.), Leica or Vexcel have been developing digital aerial cameras. As we can see today, there are two construction strategies. One is to keep the central perspective principle well-known from existing film cameras with the advantage that you can use existing software to handle the data. For this solution (called *frame camera*), an area sensor is required. Considering the fact that a high-resolution area sensor giving the same information like 230 by 230 mm photos taken on film would be extremely expensive, efforts are made to use four overlapping smaller sensors of industrial standard and then match the four image parts together (DMC from Intergraph, see figure 2). The other strategy is to use a *line sensor* across the flight direction and collect data continually during the flight. This is a bit similar to the techniques known from sensors on satellites or from hyper-spectral scanners (ADS 40 from Leica).



Fig. 3: Example of metric digital cameras: The medium-format AIC (left) and the small-scale d7 metric (right) from Rollei. Courtesy of Rollei Fototechnic, Germany.

For the close-range case the transition from film to digital cameras can be described in the way that existing film cameras are still in use, but if a new camera shall be purchased it will be a digital one in any case. On the market are small-format and medium-format cameras like those from Rollei (d7 metric, d30 metric or the AIC, also well suitable for the aerial case, see figure 3).

Nowadays digital consumer cameras have reached a high technical standard and good geometric resolution and are available for low prices. Due to the fact that these cameras can be used for close-range photogrammetry without any problem if the accuracy to be reached is not too high, a separate chapter will deal with this kind of equipment.

1.4 Digital consumer cameras

As mentioned just before, various types of digital consumer cameras are on the market which may also be used for photogrammetric applications. The differences of the construction principles between metric and consumer cameras can be seen in general in quality and stability of the camera body and the lens. Further, consumer cameras usually have a zoom (“vario”) lens with larger distortions which are not constant but vary for instance with the focal length, so it is difficult to correct them with the help of a calibration.

If you want to purchase a digital camera to use it for photogrammetry please take the following remarks into account:

General: It should be possible to set the parameters focal length, focus, exposure time and f-number manually, at least as an option.

Resolution (Number of pixels): Decisive is the real (physical), not an interpolated resolution! The higher the number of pixels, the better – but not at any price: Small chips with a large number of pixels of course have a very small pixel size and are not very light sensitive, furthermore the signal-noise ratio is less good. This you will find especially with higher ISO values (200 and more) and in dark parts of the image.

Focal length range (zoom): Decisive is the optical, not the digital (interpolated) range!

Distance setting (focus): It should be possible to de-activate the auto focus. If the camera has a macro option you can use it also for small objects.

Exposure time, f-number: The maximum f-number (lens opening) should not be less than 1:2.8, the exposure time should have a range of at least 1 ... 1/1000 seconds.

Image formats: The digital images are stored in a customary format like JPEG or TIFF. Important: The image compression rate must be selectable or, even better, the compression can be switched off to minimise the loss of quality.

Storage: Usual are SD memory cards with capacities up to 4 GB. Modern PCs / Laptops are supplied with SD card readers – this will save accumulator energy when transferring data from the camera to the computer.

Energy supply: Make sure that you can use customary batteries or accumulators. They are much cheaper than special ones and available everywhere.

Others: Sometimes useful are a tripod thread, a remote release and an adaptor for an external flash. Two sets of accumulators, a battery charger, additional memory cards, if need be a card reader and a good tripod complete the equipment. A final remark: As everywhere in life, “cheap” is not always equal to “good”! Therefore you should better proof the quality than the price...

To work with image data from a digital camera you need some information like the focal length or the size of the pixels on the CCD chip. In the appendix you find a table with technical data of several CCD chips, and in the tutorials 3 and 4 you will see how to handle the images.

1.5 Short history of photogrammetric evaluation methods

In general, three main phases of photogrammetry can be distinguished concerning the techniques of the equipment used for evaluation and the resulting workflow. The transition from one phase to the following took a time of about 20 years or even more.

In the chapter 1.1 you saw that, if we want to get three-dimensional co-ordinates of an object point, we must reconstruct the rays belonging to this point from the terrain through the projection centres into the central perspective photos, a procedure which we call *reconstruction of the orientation* or briefly *orientation*. In the first decades of photogrammetry this was done in a pure optical-mechanical way. The large, complicated and expensive instruments for this could only be handled with a lot of experience which led to the profession of a photogrammetric operator. Not only the orientation of the photos but also any kind of the following work like measuring, mapping and so on was carried out mechanically. In later times, this phase was named the *Analogue Photogrammetry*.

With the upcoming of computers, the idea was to reconstruct the orientation no more analogue but algorithmic – via formulas with their parameters (coefficients) being calculated and stored in the computer. The equipment became significantly smaller, cheaper and easier to handle, and was supplied with linear and rotation impulse counters to register hardware co-ordinates, and with servo motors to provide the ability to position the photos directly by the computer. Nevertheless, the work still was done with real (analogue) photos and still needed a high precision mechanical and optical piece of equipment, the so-called *analytical plotter*. According to that, this phase was called *Analytical Photogrammetry*.

As everybody knows, in the last decades the power of computers rose at breathtaking speed. So, why not use digital photos and do the work directly with the computer? Even a simple PC nowadays has power and storage capacity enough to handle high-resolution digital photos. That is the phase now: *Digital Photogrammetry*, and that’s what we want to explain with the help of this book, the included

software and some examples. The only remaining analogue part in the chain of a total digital workflow often are the photos themselves when taken with traditional cameras on film, but also this will end soon.

For existing photos on film or paper, we will need a high-precision scanner as the only special hardware periphery. And due to the fact that around the world hundreds of “classical” aerial cameras are in use – instruments with a lifetime of decades – and digital cameras are much more expensive up to now, photo production on film with subsequent scanning may be the standard for many years (MAYR 2002). On the other hand we must recognise that a totally digital workflow has much advantages and is much faster, and no film development is necessary, a fact which significantly decreases the costs.

1.6

Geometric principles 1: Camera position, focal length

To explain the relation between the distance camera position – object (aerial case: flying height) and the focal length, we use a terrestrial example. First, take a look at figure 4:

Our goal is to take a photo of the house, filling the complete image area. We have several possibilities to do that: We can take the photo from a short distance with a wide-angle lens (like camera position 1 in the figure), or from a far distance with a small-angle lens (telephoto, like camera position 2), or from any position in between or outside. Obviously, each time we will get the same result. Really?

Figure 5 shows the differences. Let’s summarise them:

- The smaller the distance camera – object and the wider the lens angle, the greater are the displacements due to the central perspective, or, vice versa:
- The greater the distance camera – object and the smaller the lens angle, the smaller are the displacements.

In a (theoretical) extreme case, if the camera could be as far as possible away from the object and if the angle would be as small as possible (“super telephoto”), the projection rays would be nearly parallel, and the displacements near to zero. This is similar to the situation of images taken by a satellite orbiting some hundreds of kilometres above ground, were we have nearly parallel projection rays but also influences coming from the earth curvature. The opposite extreme case are photos taken with a *fisheye* lens which have an opening angle of up to 180 degrees, sometimes called whole-sky-systems.

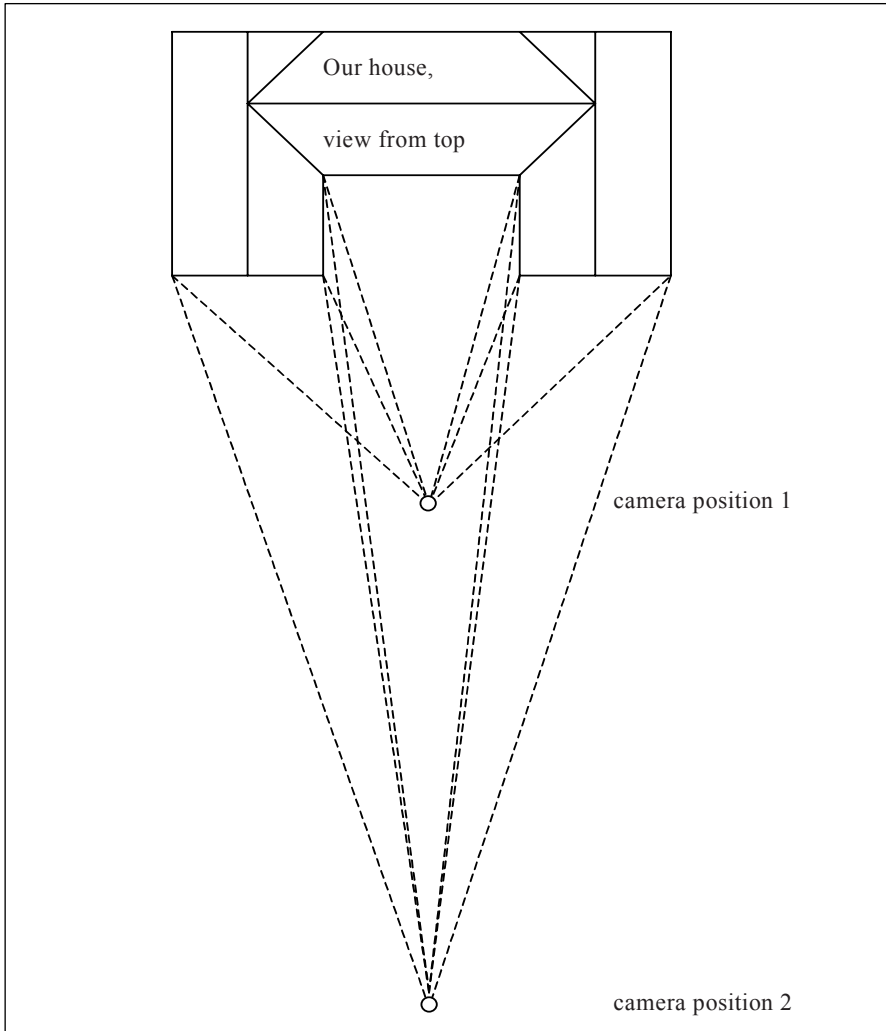

Fig. 4: Different positions and lens angles. The situation, view from above.

What are the consequences? If we would like to transform a single aerial image to a given map projection, it would be the best to take the image from as high as possible to have the lowest displacements – a situation similar to satellite images (see above). On the other hand, the *radial-symmetric displacements* are a prerequisite to view and measure image pairs stereoscopically as you will see in the following chapters, and therefore most of the aerial as well as terrestrial photos you will use in practise are taken with a wide-angle camera, showing relatively high relief-dependent displacements.

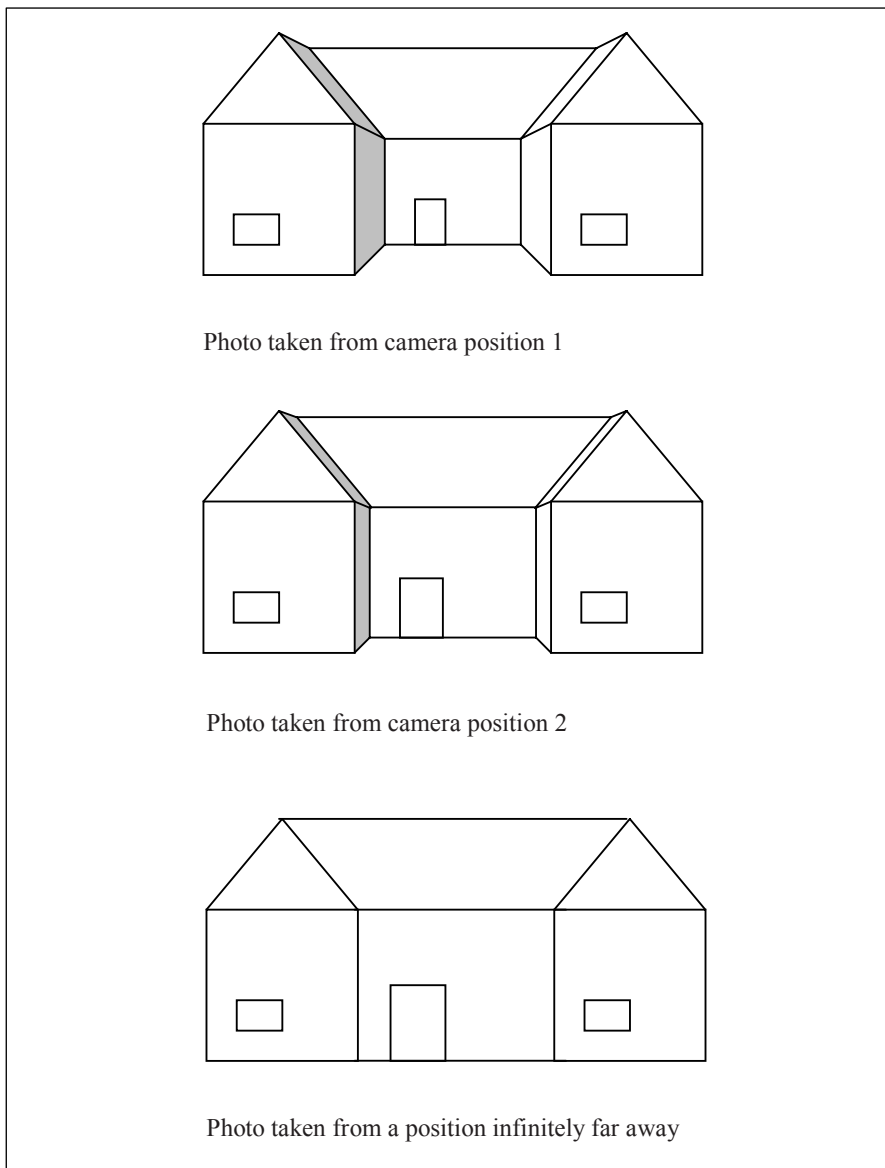

Fig. 5: The results: Photos showing the house in same size but in different representations due to the central perspective.

1.7

Geometric principles 2: Image orientation

As already mentioned before, the first step of our work will be the reconstruction of the orientation of each photo, which means that we have to define the exact position of all photos which we want to use within the object (terrain) co-ordinate system. Now please imagine the following: If we know the co-ordinates of the projection centre, the three rotation angles (against the x-, y- and z-axis) as well as the focal length of the camera (part of the interior orientation, see chapter 4.2.2), then the position of the photo is unequivocally defined (see figure 6). Therefore our first goal will be to get the six *parameters of the exterior orientation* ($x_0, y_0, z_0, \varphi, \omega, \kappa$; see chapter 4.2.5).

In the case of aerial photos, the values of φ (phi) and ω (omega) will normally be near to zero. If they are exactly zero, we have a so-called *nadir photo*. But in practice, this will never happen due to wind drift and small movements of the aircraft. Always remember the rule “nothing is exact in real life”! The value of κ (kappa) is defined as “east = zero” according to the x-axis of the terrain co-ordinate system, then counting anti-clockwise in grads, defining north = 100, west = 200, south = 300 grads (see chapter 1.10 for the units).

Please note that only exact nadir photos of a true horizontal plane would have a unique scale or, in other words, non-zero values of φ and/or ω as well as the form of the object (for instance the relief) lead to scale variations within the photo.

If M_b is the mean photo scale or m_b the mean photo scale number, h_g the height of the projection centre above ground and f the focal length, we can use the following formulas (see figure 7):

$$m_b = h_g/f \quad \text{or} \quad M_b = 1/m_b = f/h_g \quad 1.7.1$$

Now take a look at the different co-ordinate systems (CS) which we have to deal with. First, the camera itself has a two-dimensional CS; this may be a traditional or a digital one (*image CS*). Second, in case of film or paper material we must use a scanner which has a two-dimensional pixel matrix (*pixel CS*) – the equivalent to the photo carrier co-ordinates of an analytical plotter (see chapter 1.5). And finally our results should be in a three-dimensional *object (terrain) CS* – normally a rectangle system like used for the Gauss-Krueger or the related UTM projection, connected with an ellipsoid to define the elevation (for instance, in Germany the Gauss-Krueger system is related with the Bessel ellipsoid, the UTM system with the ellipsoid defined from Hayford).

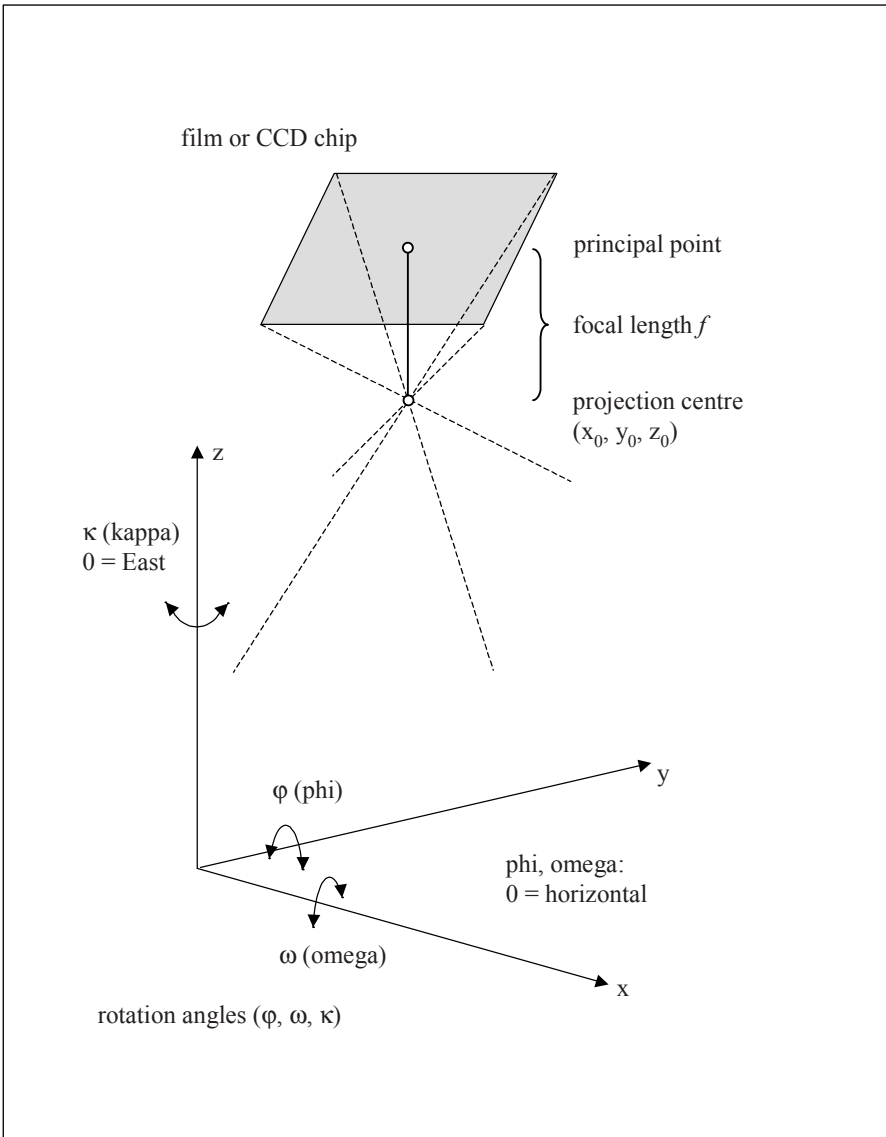

Fig. 6: Focal length, projection centre and rotation angles

As we will see later on, the values of the three rotation angles depend on the sequence in which they were calculated. Often used are the sequences φ, ω, κ and ω, φ, κ – most software packages have the option to convert the angle values between these sequences.

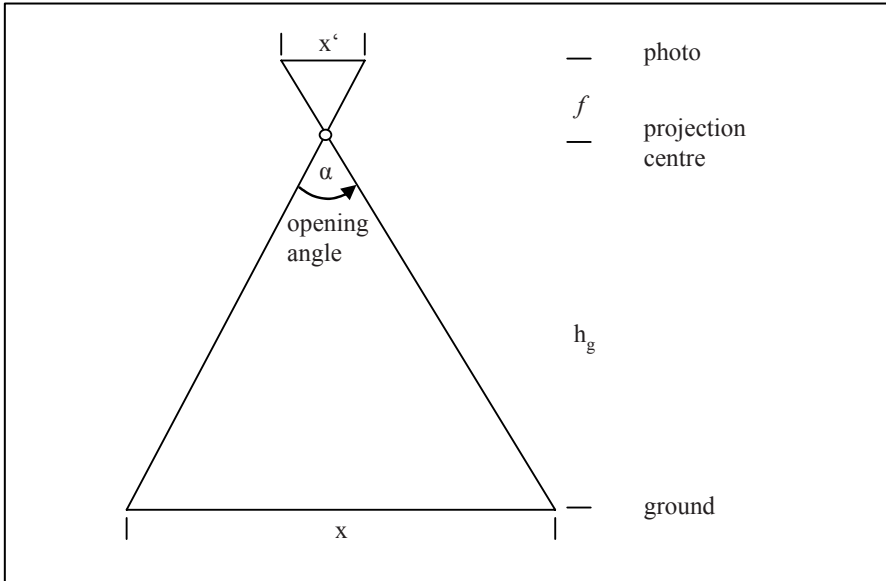

Fig. 7: Relations between focal length f , height above ground h_g and the photo scale f/h_g

1.8 Geometric principles 3: Relative camera positions (stereo)

To get three-dimensional co-ordinates of object points we need at least two images from our object, taken from different positions, as we already said in chapter 1.1. This leads to the question which rules we must fulfil concerning the relative camera positions.

Remember figure 1: The point $P(x, y, z)$ will be calculated as an intersection of the two rays $[P' \rightarrow P]$ and $[P'' \rightarrow P]$. You can easily imagine that the accuracy of the result depend among others from the angle between both rays. The smaller this angle, the less will be the accuracy: Take into account that every measurement of the image points P' and P'' will have more or less small errors, and even very small errors here will lead to a large error especially in z when the angle is very small. Besides, this is a further reason why wide-angle cameras are preferred in photogrammetry (see next figure).

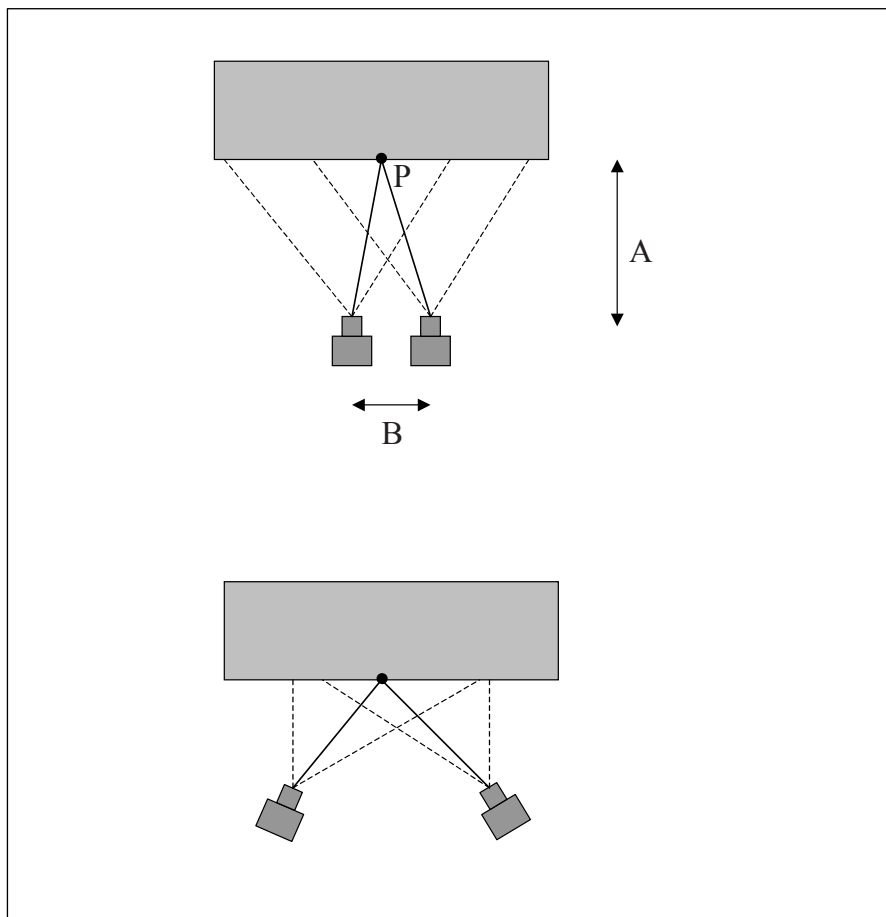

Fig. 8: Camera positions parallel (above) and convergent (below). MapTEC, Germany (2004).

Let A be the distance between the cameras and the object and B be the distance between both cameras (or camera positions when only a single camera is used), then the angle between both projection rays (continuous lines) depend on the ratio A/B , in the aerial case called the *height-base ratio*. Obviously you can improve the accuracy of the calculated co-ordinates $P(x, y, z)$ by increasing the distance B (also called *base*, see figure 1). If then the overlap area (stereo model, see next chapter) is too small you may use convergent camera positions – “squinting” in contrast to human vision (parallel). The disadvantage of this case is that you will get additional perspective distortions in the images. Please keep in mind: The parallel (aerial) case is good for human stereo viewing and automatic surface reconstruction, the convergent case often leads to a higher precision especially in z direction.

1.9 Some definitions

Before starting with the practical work, we want to introduce some standard technical terms of photogrammetry.

- *Photo*: The original photo on film
- *Image*: The photo in digital representation – the scanned film or the photo directly taken by a digital camera
- *Model (stereo model, image pair)*: Two neighbouring images within a strip
- *Strip*: All overlapping images taken one after another within one flight line
- *Block*: All images of all strips
- *Base*: Distance between the projection centres of neighbouring photos

To illustrate what we mean, please take a look at the next figure:

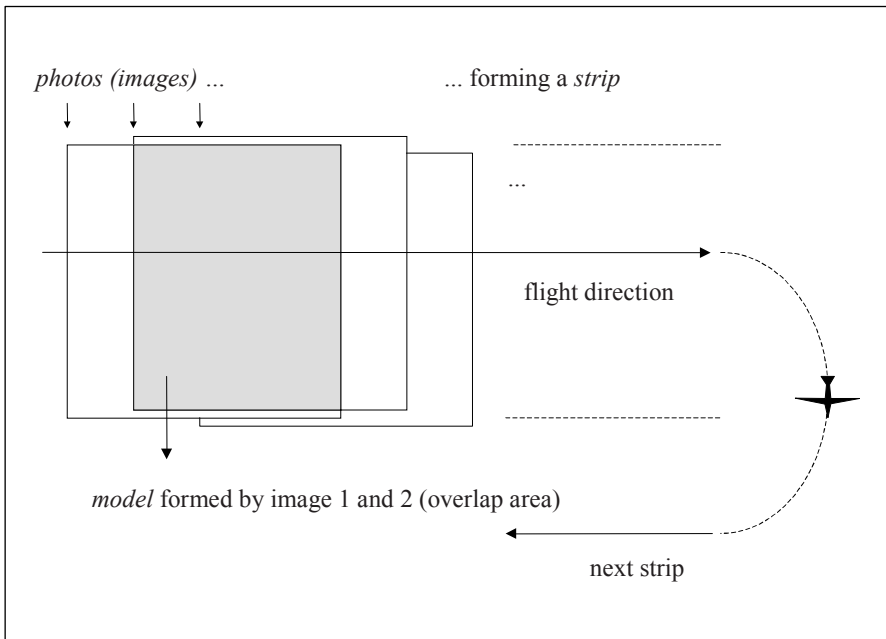

Fig. 9: Photos, models and strips forming a block

An image flight normally is carried out in the way that the area of interest is photographed strip by strip, turning around the aircraft after every strip, so that the strips are taken in a meander-like sequence. The two images of each model have a longitudinal overlap of approximately 60 to 80% (also called *end lap*), neighbouring strips have a lateral overlap of normally about 30% (also called *side lap*). As

we will see later on, this is not only necessary for stereoscopic viewing but also for the connecting of all images of a block within an aerial triangulation (see figure 32).

1.10 Length and angle units

Normally, for co-ordinates and distances in photogrammetry we use *metric* units, the international standard. But in several cases, also non-metric units can be found:

- Foot ('): Sometimes used to give the terrain height above mean sea level, for example in North American or British topographic maps, or the flying height above ground.
- Inch ("): For instance used to define the resolution of printers and scanners (dots per inch).

$$1' = 12'' = 30.48 \text{ cm}$$

$$1\text{m} = 3.281'$$

$$1'' = 2.54 \text{ cm}$$

$$1 \text{ cm} = 0.394''$$

1.10.1

You will surely know angles given in *degrees*. In mathematics also *radians* are common. In geodesy and photogrammetry, we use *grads*. In the army, the so-called *mils* are used.

A full circle has

$$360 \text{ degrees} = 400 \text{ grads} = 2\pi \text{ (pi)} = 6400^- \text{ (mils)}$$

1.10.2

1.11 A typical workflow in photogrammetry

Before starting our practical work let's take a look at the next figure, showing us the typical workflow for photogrammetric applications. Beginning with the capture of the images, we have then to calculate the orientation parameters of all images we want to use. After this we can measure co-ordinates, create several kind of image products like surface models, and finally we may use the results in additional cartographic or GIS software.

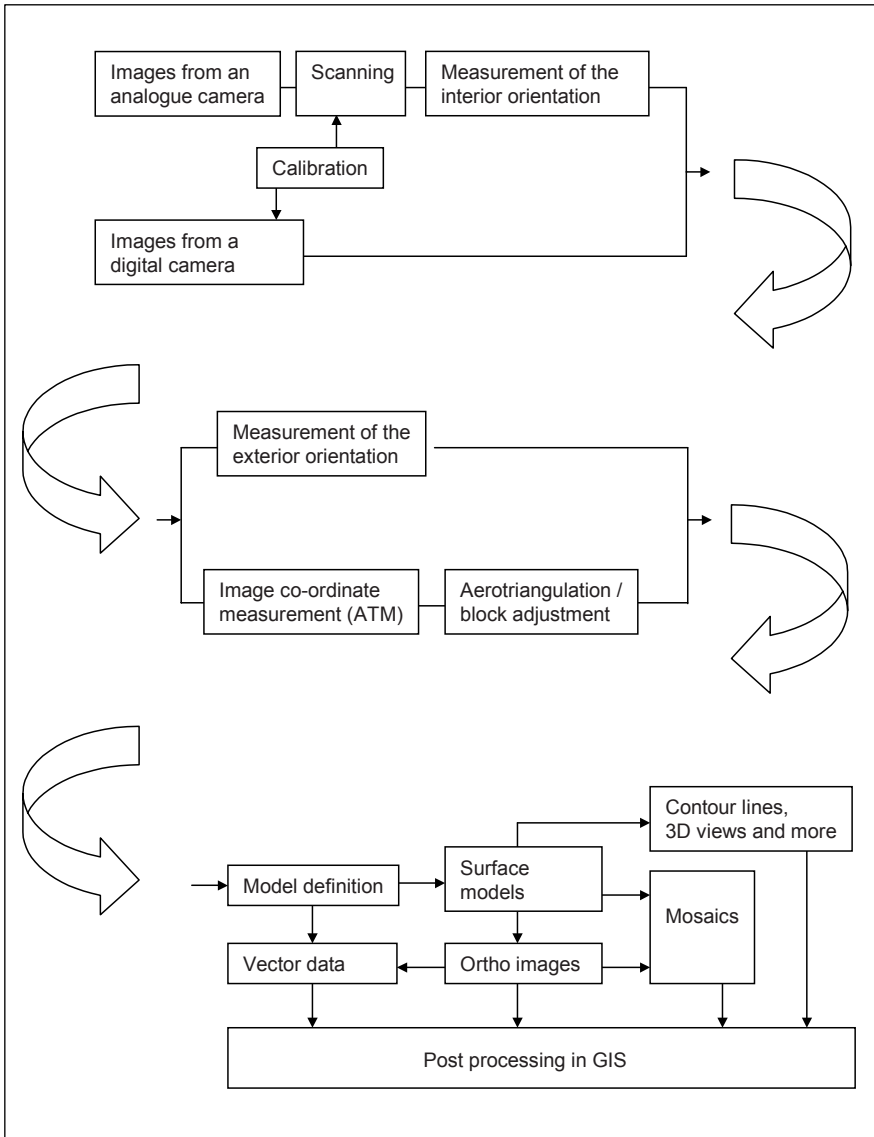

Fig. 10: A typical workflow

2 Included software and data

2.1

Hardware requirements, operating system

If you want to use the software included on the CD-ROM and work with the example data or even use your own materials, it is necessary to have an adequate PC supplied with sufficient main memory (RAM), storage capacity (hard disk) and high resolution graphics. In particular, you need:

	Minimum	Recommended
Processor frequency	400 MHz	>> 1 GHz
Main memory (RAM)	256 MB	>> 512 MB
Hard disk	1 GB	>> 10 GB
Graphics resolution	1024 x 768 pixels	1280 x 1024 pixels
Screen size	17"	21"
Mouse	3 (!!) buttons	central wheel

Furthermore, to handle (aerial) photos on paper or film material, you need a scanner (see chapter 3). For stereoscopic viewing you need red-green glasses, a simple example is included in this book. You need a mouse with 3 buttons or with a central wheel which, when pressed down, also serves as middle mouse button.

It is urgently recommended to use a professional operating system like MS Windows NT (with service pack 6), 2000, XP or Vista. Nevertheless, you may also use MS Windows 95, 98, ME and other MicroSoft Windows 32 bit systems, but then no guarantee can be given for full functionality! In particular, older operating systems like Windows 95 and 98 didn't support the FREEIMAGE library used in some parts of the software (for instance, see chapter 7.6.4).

2.2

Image material

In the first tutorials we will process aerial photos which were taken by an analogue aerial camera (see chapter 1.3) in the usual format of 23 by 23 cm (9 by 9") which must be converted into a digital format using a scanner. Nevertheless, also images from non-metric, réseau or digital cameras, and not only aerial but also terrestrial photos can be handled.

From a practical point of view, for the following tutorials all image material is prepared in digital representation on the CD-ROM. To help you handle your own examples, chapter 3 will discuss the basic principles of scanning paper or film photos. Beside this, you may of course use images taken with a digital camera.

The aerial photos used in chapter 4 and 5 are owned by the Corporación Autónoma del Valle del Cauca (CVC), Cali, Colombia. Thanks to Ing. Carlos Duque from the CVC who managed everything to give me the rights using these photos here.

The photos used in chapter 6 are owned by the Institute of Photogrammetry and GeoInformation (IPI) of the University of Hannover, Germany. Thanks to Dr.-Ing. Folke Santel for her patience and help.

A new chapter in the 3rd edition, 6.6, deals with high resolution satellite images. For our tutorial we will use images from the Cartosat-1 satellite, showing an area south-west of Warszawa, Poland. Thanks to the Space Application Centre ISRO, Ahmedabad, India, and to GEOSYSTEMS Polska, Warszawa, for the courtesy to use the data (images and control points) in this book!

2.3

Overview of the software

On the CD-ROM delivered with this book you find a small but really useful digital photogrammetric software package with which you can make everything described in the following chapters and much more. In particular, the software is *not* limited to the example data but can be used for a wide range of photogrammetric tasks. The package is divided into three parts:

LISA BASIC: A raster GIS software with a lot of possibilities in image processing, terrain modelling and more. A complete programme description will be copied onto your PC during the installation (see c:\lisa\text). You can choose between the English, German or Spanish language version. Copyright by the author.

LISA FOTO: Extension of LISA BASIC, digital photogrammetric workstation. This is the main software used in the following chapters. The programme description is given in chapter 7 of this book but will also be copied onto your PC during the installation (see c:\lisa\text). You can choose between the English, German or Spanish language version. Copyright by the author.

LISA FFSAT: Digital photogrammetry for stereo satellite data. Developed by the author in cooperation with Dr.-Ing. Karsten Jacobsen, University of Hannover.

The LISA programmes delivered with this book are special versions with slightly reduced functionality: The maximum size per image is limited to 10 MB, only grey scale (not colour) images can be processed, and the tools to create and handle a data base for geocoded images are not available. See chapter 2.7 for information about the complete software.

BLUH: A professional bundle block adjustment software optimised for aerial triangulation. A “light” version including the central five modules of this programme system with reduced functionality will be installed on your computer. Only available in English but with manuals also in German and Spanish (see c:\lisa\text). Copyright by Dr.-Ing. Karsten Jacobsen from the Institute of Photogrammetry and GeoInformation, University of Hannover, Germany.

According to HEIPKE (1995) and SCHENK (1999), the following functionality of a digital photogrammetric workstation (DPW) is provided:

- Stereo DPW: Interactive stereo plotting, optional elevations from a DTM
- Mono DPW: Planimetric plotting, optional elevations from a DTM
- Aerial triangulation DPW: Manual and automatic aerial triangulation measurement, block adjustment with BLUH
- DTM DPW: Automatic derivation of terrain models, contours etc.
- Ortho image DPW: Creation of ortho images and mosaics

All programmes are mostly written in Fortran 95, few parts in C++. Using inline code programming and other functions of the powerful FTN95 Fortran compiler, real-time zooming and roaming was realised and an easy-to-use design could be created.

If you still like to use the software after reading this book, may be for your own applications, it is a good idea to look onto my homepage and to download actual software versions from time to time (<http://www.lisa-geosoftware.de>).

2.4 Installation

Important: If you use a professional operating system like MS Windows NT, 2000, XP or Vista, it might be necessary to log in with full rights, usually select user = administrator!

Put the CD-ROM into your PC. Start a file manager like MS Windows Explorer, Norton Commander or similar, and go to the CD drive. Now click onto SETUP. The rest is standard and self-explanatory. The default values given by the installation software should be used if possible. *For consistency with the data on the CD-ROM it is urgently recommended to use the proposed installation path c:\lisa!* Now all of the software we need is ready-for-use, and all directories for the tutorial data are created. Finally we have to copy the data which normally will be done by the setup; if not, simply click onto SET_DATA.

Now click successively onto Start, Settings, System control, then onto the icon Display and again onto Settings. Control / set the following parameters:

- *Colours*: 65536 colours (“high colour”, 16 bit) or higher.
- *Resolution*: At least 1024 x 768 pixels.
- *Fonts*: “Small fonts”.

Now click above onto Representation. Within windows (active or inactive) as well as the dialogue box the following parameters may not be exceeded:

- *Pixel*: Size 18
- *Text*: Size 10

In case you have less than 512 Mbytes main memory (RAM) available on your computer and/or you want to process large raster images a certain part of the hard disk capacity can be made available in addition. Therefore a correspondingly large paging file is to be defined within the Windows system control: successively click Start, Settings, System controls, then onto the icon System and there onto Performance data. In the menu Virtual storage you can define the size of the paging file using the button Modify. For more details, please refer to the Windows manual.

After the installation has finished, you will find the following additional directories on your PC:

c:\lisa	LISA and BLUH programme files, fonts, runtime libraries etc.
c:\lisa\text	LISA and BLUH manuals, PDF format
c:\lisa\common\pal	directory for palettes
c:\lisa\common\sig	directory for area symbols
c:\lisa\common\cam	directory for cameras

c:\lisa\cameras	some standard aerial camera definitions
c:\lisa\tutorial_1	data prepared for tutorial 1
c:\lisa\tutorial_2	data prepared for tutorial 2
c:\lisa\tutorial_3	data prepared for tutorial 3
c:\lisa\tutorial_4	data prepared for tutorial 4
c:\lisa\tutorial_5	data prepared for tutorial 5

If you prefer to use the German or Spanish programme versions of LISA, just copy the executables (*.EXE) and the descriptions (*.PDF) from the CD-ROM into the respective directories on your PC (c:\lisa, c:\lisa\text).

2.5 Additional programmes, copyright, data

Beside the software mentioned before, some further programmes are used:

- For the development of the LISA programmes: Products from the Salford Software Ltd. company, England, now purchased by SilverFrost Ltd. (compilers FTN95, CPP and SCC, editor SIDE, ClearWin+ library etc.). See also <http://www.silverfrost.com/>
- For the installation of the software: InstallUs from Schellhorn media productions, Germany. See also <http://www.media21.de/>
- For the import and export of some raster image formats, the FREEIMAGE library is used. See also <http://freeimage.sourceforge.net/>
- For the real-time display of 3D data, my friend Dr. Michael Braitmeier wrote a plug-in called IMA3D.
- This book was written using MS Word, all graphics have been created using MS PowerPoint from MicroSoft, USA. See also <http://www.microsoft.com/>

All software used for the tutorials or mentioned in this book, including the brand names, are under copyright of the respective authors and/or companies!

2.6 General remarks

During the standard installation process, you have only those data files copied onto your hard disk which are used as input files in the following tutorials (see chapter 2.4). Besides, many of the intermediate and final results are also prepared on the CD-ROM (sub directory data\tutorial_x\output, see below) and can be used

for control purposes or, if you would like to skip some steps and go on later, to get intermediate results necessary for the following steps. Therefore, at the end of any tutorial chapter all created files are listed.

For consistency it is a really good idea to use the file names proposed in the tutorials. In general, it is of course possible to choose any output name.

The CD-ROM has the following directory structure:

deutsch	(... if you prefer to work with the German
espanol	or the Spanish LISA versions)
data\tutorial_x\input	(... directory with input data, x = 1 ... 5)
data\tutorial_x\output	(... directory with some intermediate and final results for control purposes, x = 1 ... 5)
figures	all figures of this book, stored as MS PowerPoint files

To make the work a bit clearer in the following tutorials, special fonts are used:

- Options and parameters: For instance, Image No. refers to the corresponding text in an input window.
- Menu entries: Separated by “>”, for example: Processing > Stereo measurement means that you first have to click onto Processing, then onto Stereo measurement.
- *Definitions* or *key words* are printed in italics.
- Any results stored in a file and listed here for control purposes are printed in this font.
- File names are always printed in UPPERCASE letters.
- Units are printed in [square brackets], example: [μm].
- Vectors are also printed in square brackets with an arrow showing the direction like [start point \rightarrow ending point].

See also chapter 7.4 for some remarks about the programme handling.

2.7 Software versions, support

The software presented here is distributed by LISA Geo-Software, Germany, and by the Institute of Photogrammetry and GeoInformation (IPI), University of Hannover, Germany. For details about unlimited or student programme versions, update downloads, news and prices please look at our homepage (<http://www.lisa-geosoftware.de>). If you have questions or need support don't hesitate to mail to info@lisa-geosoftware.de.

Note: To purchase an unlimited version you must use the Registration button right-hand in the main window, fill out the form and send us the file t2v_reg.txt (see the LISA BASIC programme description). Students also may purchase a “student version”.

Within LISA BASIC, FOTO or FFSAT you can use the buttons Info and then Homepage or E-Mail to contact these addresses from within the software.

3 Scanning of photos

3.1 Scanner types

A lot of scanners exist on the market with differences in construction, geometric and radiometric resolution, format size and last but not least price. For use in photogrammetry, some basic requirements must be fulfilled: Format A3, transparency unit (for film material), high geometric and radiometric resolution and accuracy.

The format A3 is necessary because for photogrammetric purposes the photos must be scanned in total, in particular including the fiducial marks (see chapter 4.2.1), and most of the aerial photos usual today have the format 23 by 23 cm (9 by 9") which exceeds the A4 format. On the other hand, the side information bar (mostly black; contains additional information like altimeter, clock, film counter) should not be scanned to save storage capacity. Remark: If you only have an A4 scanner, you may use a special option of the software (see chapter 6.1) according to our principle "Something is more than nothing".

In low-cost photogrammetry often flatbed (DTP) scanners are used with a geometrical accuracy of about $50\mu\text{m}$ (see for instance BALTSAVIAS & WAEGLI, 1996 or WIGGENHAGEN, 2001). For a better understanding, three important aspects of influence shall be mentioned:

- Accuracy along the CCD array (charge coupled device; under the moving bridge beneath the glass plate): Constancy of size, distance and linear arrangement of the CCD elements.
- Accuracy across the CCD array (in moving direction of the bridge): Constancy of step width and linearity of the moving.
- Angle between bridge and moving direction: Deviations from a rectangle.

Some words about the radiometric resolution: The absolute minimum a photogrammetric scanner must have is the possibility to scan grey scale (panchromatic) photos with 8 bit which means 256 grey levels. In case of colour photos, normally

we need a radiometric resolution of 24 bit which means 8 bit or 256 levels for each of the three base colours (red, green, blue), scanned in single-pass mode.

3.2 Geometric resolution

The geometrical scan resolution is given in the units “dots per inch” [dpi] or micrometers [μm] and reflects on the maximum accuracy to attain. For simple photogrammetric investigations as shown in this book, a value of 300 or 600 dpi may be used. A scan resolution of 600 dpi (42 μm) is near to the geometric accuracy of most flatbed scanners (about 50 μm , see above). The conversion from [dpi] to [μm] is based on the formula:

$$\begin{aligned} \text{pixel size in } [\mu\text{m}] &= 25400 / \text{resolution in [dpi]} && 3.2.1 \\ \text{resolution in [dpi]} &= 25400 / \text{pixel size in } [\mu\text{m}] \end{aligned}$$

The table below serves to illustrate the relation between scan resolution in [dpi] or [μm], the image size in [MB] (grey scale / 8 bit photo), the aerial photo scale and the ensuing pixel size in terrain units, usually [m]:

Resolution [dpi]	150	300	600	1200	2400	4800
Pixel size [μm]	169.3	84.7	42.3	21.2	10.6	5.29
Image size ca. [MB]	2	8	32	128	512	2018

Photo scale

1: 5000	0.847	0.423	0.212	0.106	0.053	0.026
1: 7500	1.270	0.635	0.318	0.159	0.079	0.040
1:10000	1.693	0.847	0.423	0.212	0.106	0.053
1:12500	2.117	1.058	0.529	0.265	0.133	0.066
1:15000	2.540	1.270	0.635	0.317	0.159	0.079
1:17500	2.963	1.482	0.741	0.370	0.175	0.093
1:20000	3.386	1.693	0.846	0.424	0.212	0.106
1:25000	4.233	2.117	1.058	0.529	0.265	0.132
1:30000	5.080	2.540	1.270	0.634	0.318	0.159
1:40000	6.772	3.386	1.693	0.846	0.424	0.212
1:50000	8.466	4.234	2.116	1.059	0.530	0.265

Pixel size in terrain units ca. [m]

For the geometrical scan resolution it is a good idea always to follow the rule “As high as necessary, as low as possible”! On the other hand, the maximum attainable accuracy in z (altitude) depends, among other factors, on the scan resolution. The accuracy in z can reach a value of 0.1 ‰ (per thousand) of the flying height above terrain, using an analytical plotter and photos with an end lap of 60%.

3.3 Radiometric resolution

Only grey scale photos (8 bit / 256 grey values) can be used with the software versions prepared on the CD-ROM (see chapter 2.3). Colour images may be scanned also with 8 bit and stored as grey scale images, or with 24 bit and subsequently be separated into three colour extracts of 8 bit each, *one* of which will be used. A further possibility is to scan with 24 bit and calculate a “mixed” monochrome image using the well-known formula

$$\text{Grey value} = 0.3 * \text{red} + 0.11 * \text{green} + 0.59 * \text{blue} \qquad 3.3.1$$

For instance, this formula is used if you import a 24 bit image in LISA BASIC, using File > Import raster image > BMP 24 bit, then activating the option Mixed image (see also the programme description).

3.4 Some practical advice

As a general rule the photos should be put onto the glass plate in the way that the direction of the strip (flight) is parallel to the CCD array of the scanner (see figure 11). It is suggested that all photos are first arranged on a table in the same position and orientation in which they form the block. This means that, for example, all photos are situated with “top = north” independent from the position of the side information bar. Then every photo is scanned “west-east parallel to the CCD array” (see figure 12). This method has the advantage that the resulting digital images are arranged in the same way as they follow in the strip.

- If at all possible only master film material should be used as scan sources. If film is not available prints must be used instead. They should be processed on plain (non-textured) paper of high geometrical stability.
- Please note that the *whole* aerial photo must be scanned – in particular, the fiducial marks must be included, which we will need to establish the *interior*

orientation (see chapter 4.2.2). On the other hand, the photo borders and the side information bar should not be scanned to save memory space.

- Grey scale images must be stored as “grey scale”, not as “colour” images! The standard file formats to choose for storing and later to import into LISA FOTO are BMP, JPEG or TIFF (8 bit, grey scale, uncompressed). Please note: The file extensions used by LISA are JPG (not JPEG) or TIF (not TIFF)!
- Image names: As a general rule, the image *names* should be identical with the image *numbers* with no other or further text. Example: Image No. 137 will be stored, depending on the format, as 137.BMP, 137.JPG or 137.TIF, but *not* as LEFT.BMP, FOTO_137.BMP or anything else.
- Some general remarks for scanning: Switch on the scanner without a photo on the glass plate! Let the equipment run at least 5 minutes to warm up. After that, put the photo onto the glass plate and cover the unused area of the plate with a black cardboard. In this way, the radiometric self-calibration of the scanner is supported.

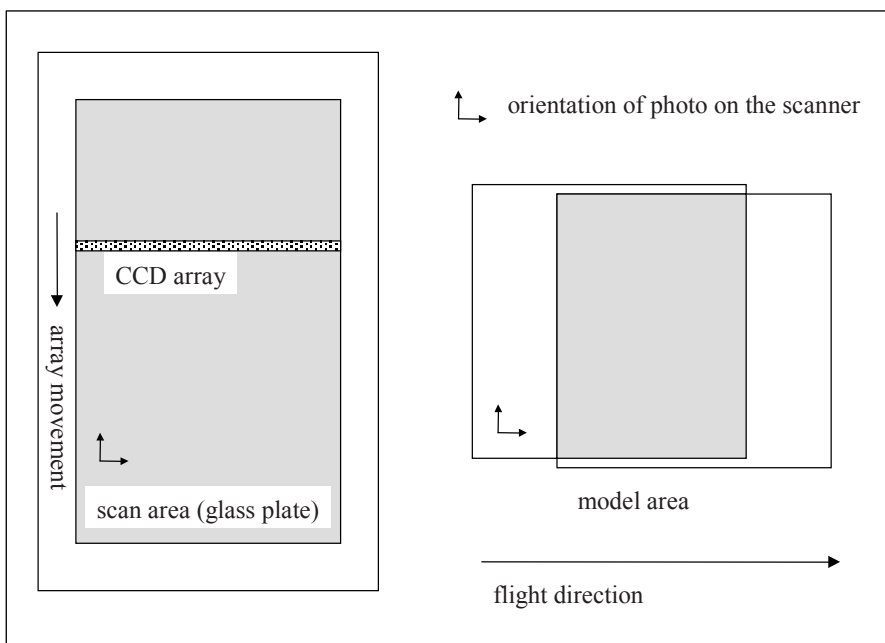

Fig. 11: Flatbed DTP scanner and suggested positions of the photos. See also figure 55.

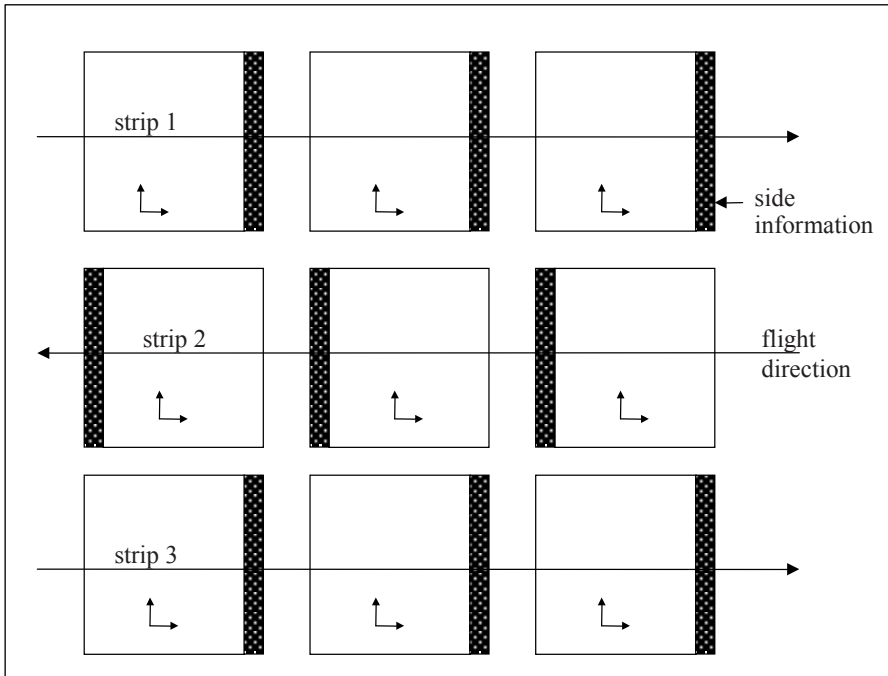

Fig. 12: All photos of a block should be scanned in the orientation in which they form the block, regardless to the flight direction.

3.5 Import of the scanned images

LISA use a special image format with the extension IMA. Within in programme, you can directly use also image data in one of the formats BMP, JPG or TIF. Nevertheless, it may be more comfortable to have all data in the same format, therefore let's take a look onto the import option:

Of course this can be done manually image by image, for example using the option File > Import raster image from the LISA BASIC module. But often you will have a great amount of images within one directory. In this case it is much easier to import all files one by one automatically (batch mode).

Please start LISA FOTO by clicking on Start > Programmes > LISA > FOTO, then go to the option File > Import raster images. Choose the format (BMP, JPEG or TIFF). As you will see, you have some additional options used simultaneously for all images which shall be explained here:

- Turn by 180 degrees: If the photos were scanned against our general rule concerning the position on the glass plate.
- Half resolution: If the original data are too large, the resolution can be reduced.
- Delete originals: To save storage capacity, each original image file can be deleted immediately after the import.
- Negatives → Positives: If the photos are film negatives. To work with them, in particular for interpretation, it is better to transform them into positives.
- Numerical output name: Automatic creation of a numerical name according to our advice (chapter 3.4). Image files containing a number will be processed like FOTO_137.BMP → 137.IMA, files without any number will be stored with an increasing number (1.IMA, 2.IMA, 3.IMA, ...).
- 24 → 8 bit: True-colour images (24 bit) can be converted to 8 bit grey-scale images directly during the import to the IMA format. Please note that the software versions coming with this book on CD-ROM are limited in functionality – therefore, if you want to use your own images you should use this option if your images have 24 bit radiometric resolution.

Now click onto the OK button. A protocol window appears showing each imported image. After the last file is processed, the window will be closed.

Remark: For these import routines, parts of the FREEIMAGE library are used. Several tests have shown that the import may fail in older semi-professional operating systems like MS Windows 95 / 98, but work properly in MS Windows NT / 2000 / XP / Vista.

4 Example 1: A single model

4.1

Project definition

To work with the LISA programmes, it is necessary first to define a *project* or to select one already existing. All projects which we will use during the following tutorials are prepared and have been copied onto your computer in the installation process. Nevertheless, this is a good moment to take a look at this topic.

Start LISA FOTO by clicking on Start > Programmes > LISA > FOTO. In the first appearing window you will be asked if you want to

- Use the last project
- Select an existing project or
- Define a new project

Please select the project TUTOR_1.PRJ, then click onto the OK button. Now go to File > Edit project. In the appearing window you will see some entries – let's talk about their meaning:

Project name: This is also the name of the project definition file which has the extension PRJ and is at all times located in the LISA main directory, usually c:\lisa.

Working directory: All data we need will be searched by the programme in this directory (folder, path). In the same way, all data which we create will be stored in this directory. The button beside the input field can be used to open a directory tree view useful to browse to the desired path. If you key in a directory which did not yet exist it will be created. Important: All projects used here are prepared for the drive (hard disk) C. If you use a different drive against our advice, let's say D, you have to correct the path in all PRJ files before starting LISA!

Image data base: Optional for the handling of geocoded images in large projects. We will not need this option in our tutorials, therefore it is not necessary to define a data base.

Furthermore, a project is defined by a co-ordinate range in x, y and z and a pixel size (= geometric resolution, in terrain units). The border values of x and y usually should be multiples of the pixel size. In particular:

The co-ordinate range in x and y should be set to the outer boundaries of the whole project area. In special cases they can be set to extremely large values using the Reset button – don't do this here! Then, they will not be taken into account.

The z value range is of importance wherever digital terrain models (DTMs) will be created. Because of the fact that DTMs are 16-bit raster images with a defined relation between the pixel grey values and the corresponding heights, it is necessary to fix this relation within the project, for example when single DTMs shall be matched or mosaicked.

To help to find the border co-ordinates of x, y and z, a reference file (geocoded image or vector file) may be used. For this, the buttons Reference raster and Reference vector are prepared. Beside that you have the option to set a fixed relation between the grey values and the heights as grey value = z. In that case, a grey value of 538 will represent a z value (height) of 538m or, in other words, we will have a z resolution of one metre.

The length units (terrain units) can be selected: μm , mm, m or km. For this example all values are given in meters.

Remark: The values of pixel size, minimum and maximum height are fixed for all data within one project! Therefore it is really necessary to set values that make sense for these parameters.

In our first example, we will use the following values (all in [m]):

```
X from 1137300 to 1140000
Y from 969900 to 971700
Pixel size 5
Z from 1000 to 1700
```

Length unit: Select m [meters].

If you want to create a new project, you can use the described option when the programme starts, or use File > Define project from within the programme. In our case, just close the window, for example with the Esc key, or, if you have changed something (for instance, the path), click onto OK.

Created file: TUTOR_1.PRJ.

4.2 Orientation of the images

4.2.1 Camera definition

If we have image material coming from a film camera and then was scanned, the first step to orient an image is the so-called interior orientation which means establishing the relation between (1) the camera-internal co-ordinate system and (2) the pixel co-ordinate system (see chapter 1.7). The first relation is given by the so-called *fiducial marks* superimposed in the image and their nominal co-ordinates, usually given in [mm] in the *camera calibration certificate*. In this certificate you will also find the calibrated focal length in [mm]. After measuring (digitising) the marks, the software will be able to calculate the transformation coefficients for the relation between both systems.

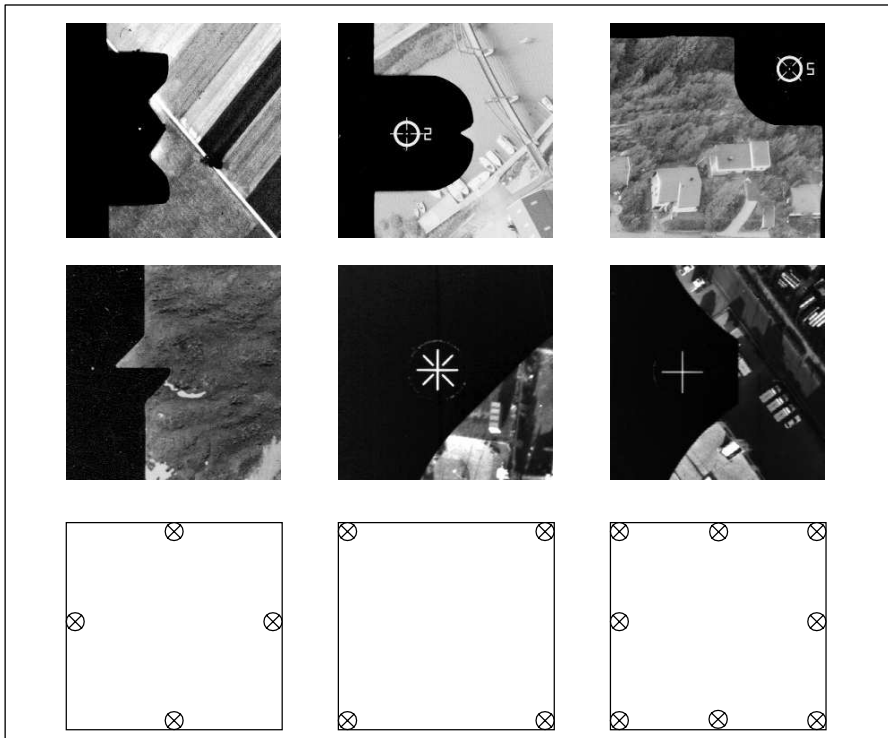

Fig. 13: Shapes (first and second row) and positions (third row) of fiducial marks in aerial photos.

Some information about the fiducial marks: Older cameras have only 4 marks, situated either in the middle of the image borders (e.g. cameras from the Zeiss company, RMK series) or in the corners (e.g. cameras from the Wild company, RC series). Newer cameras have 8 marks, situated both in the middle of the borders and in the corners.

For the camera definition we need the nominal co-ordinates of the fiducial marks and the focal length, all given in [mm]. Usually we can get these data from the camera calibration certificate, see above. If this is not available, we can get the focal length from the side information bar of the images or, if this is not possible, we can set the focal length to standard values. In case of aerial cameras these are 153 mm (wide angle) or 305 mm (normal angle). For the fiducial marks we will then also use standard values (some of them are prepared for you, see directory c:\lisa\cameras) or create a pseudo camera definition (see chapter 6.2).

In our first example we will use the following standard (nominal) data:

Fiducial No.	x value	y value
1	113.000	0.000
2	0.000	-113.000
3	-113.000	0.000
4	0.000	113.000

The focal length is 152.910 mm. In this example, we have images taken by a Zeiss RMK A 15/23 camera with 4 marks. Please start the option Pre-programmes > Camera definition > Analogue. In the appearing window, key in the values of x and y for each of the 4 fiducial marks, set the principal point to 0 for x and y, set the focal length and after that the name of the output file – in our case, please take RMK_1523.CMR. Or, just click onto the Open file button and load the prepared file into the window.

After clicking the OK button, the camera definition file will be created. For control purposes, start the text editor (for example, by clicking onto the Text button right-hand in the main window) and open the file RMK_1523.CMR. The content must be like this:

```

1  113.000    0.000
2   0.000  -113.000
3 -113.000    0.000
4   0.000   113.000
152.910
DP  -0.9999990000E+06    0.0000000000E+00
DP   0.0000000000E+00    0.0000000000E+00
PP   0.0000000000E+00    0.0000000000E+00
CS   5.000    5.000 159.806

```

Remarks: The camera definition must only be done once and is valid for all images taken with the same camera. The last four lines are without meaning here.

Created file: RMK_1523.CMR.

4.2.2 Interior orientation

As mentioned before, the next step will be measuring (digitising) the fiducial marks to set up the transformation between camera and pixel co-ordinates. This must be done once for each image which you would like to use in further work.

Please start the option Pre programmes > Orientation measurement and select the file 157.IMA in the file manager. After loading this image, the measurement interface will appear. Now go to Measure > Interior orientation. The next window will ask you for the camera definition file – please use the just created one, RMK_1523.CMR. Three further options are offered:

Turn by 180 degrees: Remember the way of taking aerial photos. In most cases, the area of interest is photographed in parallel strips with each second strip taken when “flying back” (see chapter 1.9 / figure 9). For example, strip 1 is taken flying from west to east. Then the aircraft turns around and takes the second strip flying from east to west, strip 3 again from west to east, strip 4 from east to west and so on like a meander. Now let’s say the camera definition is done with respect of the side information bar on the right side. Then, when measuring the interior orientation of strips 2, 4, 6 and so on, the option Turn by 180 degrees must be activated. In our case, don’t use this option.

Subpixel improvement: If the fiducial marks have the form of a white dot within a dark background, it is possible to let the programme make an automatic centring onto the marks with subpixel accuracy. In our example we have such marks, so please activate this option (see figure 14).

Use existing orientation: If an interior orientation was already carried out, the data can be loaded here. Please deactivate this option.

Now click onto the OK button and move the cursor into the main window showing a part of the image. The programme will automatically move the image near to the first fiducial mark. Please note the measurement principle: Fixed measuring mark, moving image like in analytical plotters! So, if you keep the middle mouse button pressed down and move the mouse, the image will move simultaneously “under” the measuring mark (default: red cross). Now move the image until the first fiducial mark lies exactly under the measuring mark, then click onto the left mouse button. If nothing happens, just move the mouse a little.

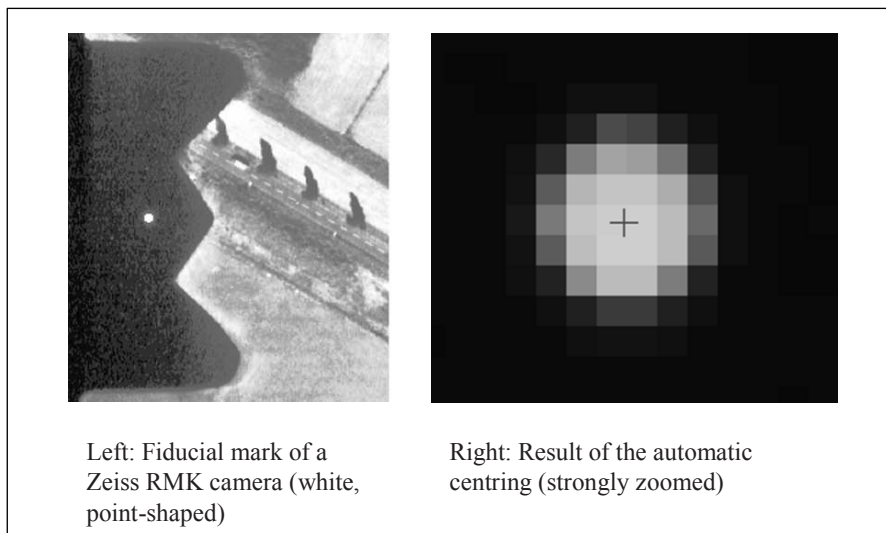

Fig. 14: Result of automatic centring of a fiducial mark.

In this and all other display modules, you may vary the brightness and the contrast to get a better impression of the image(s). We will explain the theory about this in the next chapter (4.2.3).

In the list window below you can see the measured co-ordinates, marked with M, and in the main window you can recognise that the programme has moved the image near to the second fiducial mark. Again move the image until fiducial and measuring mark are in the same position and click onto the left mouse button. In the same way measure the third fiducial mark. And now a first test of accuracy: The pre-positioning of the fourth fiducial mark should be very good, the displacement should not exceed a few pixels. What is the reason?

After three fiducial marks are measured, the programme starts calculating the transformation parameters (plane affine transformation, see chapter 4.3). If both the nominal values from the camera definition and the measurements were exact enough, the pre-positioning should be quite good. And an additional remark: This calculation is done after each measured mark beginning with the third one. So, if we would have 8 fiducial marks, then the pre-positioning should be better and better until the last mark is reached.

Back to our example: Measure the last (fourth) mark, move the mouse a little, and see the listing below which should be more or less like the following:

No.	x [mm]	y [mm]	Res. x	Res. y
1	113.000	0.000	0.014	-0.015
2	0.000	-113.000	-0.014	0.015
3	-113.000	0.000	0.014	-0.015
4	0.000	113.000	-0.014	0.015
Standard deviation [mm] :			0.014	0.015

Let's take a short look at the *residuals* (remaining errors after the adjustment): You can see that all of them have the same absolute values in x as well as in y or in other words, they are symmetrical. The reason is that with 4 points we have only a small over-determination for the plane affine transformation (at least 3 points are necessary). If you carry out an interior orientation of an image with 8 fiducial marks, the residuals will vary.

Now click onto the Ready button (checkmark). The programme will inform you about the calculated scan resolution in [dpi] and [μm] – in our case about 300 dpi or 84.7 μm . By this, you have a further check if the interior orientation was successful. Click onto OK, then close the window, for example with the Esc key.

For training purposes, please repeat this chapter with our second image, 158.

Created files: 157.INN, 158.INN.

Before going on, this is a good moment to talk about two different ways to complete the orientation. From the era of analytic photogrammetry you may know the three steps *interior – relative – absolute orientation*. Within the relative orientation the two images are “connected” by the calculation of model co-ordinates. Then, these are transformed to terrain co-ordinates in the absolute orientation.

In the following chapters we will take a different way: For each image we will first carry out the exterior orientation independently, may it be manually by measuring control points (see chapter 4.2.5) or automatically, using a method called aerial triangulation (see chapter 5.1). After that, neighbouring images are “connected” to form a model in a *model definition* (see chapter 4.3 for instance).

4.2.3 Brightness and contrast

It is one of the advantages of digital stereo photogrammetry that you can easily improve brightness and contrast “on the fly” when measuring within images. This is sometimes called a *photo lab at your fingertips*. Now, what happens?

The grey values of an image (range 0 ... 255) are displayed with exactly these values used to set the brightness of each pixel. But, establishing a linear equation between image and display, brightness and contrast can easily be changed. Figure 15 shows the results.

Let g be the grey value of a pixel in the image, then

$$f(g) = c * g + b \tag{4.2.3.1}$$

defines the grey value on the screen with contrast (c) and brightness (b).

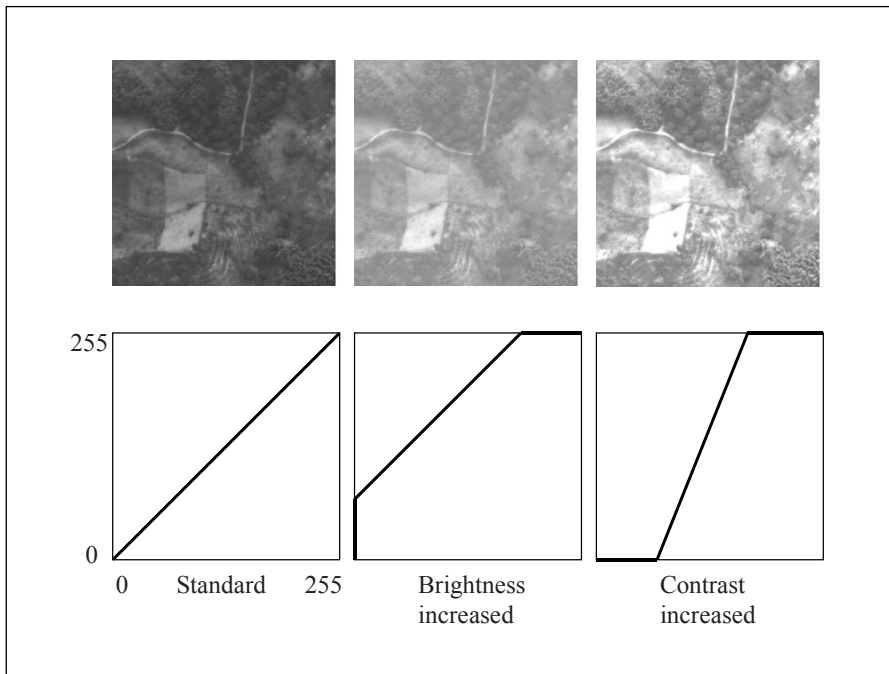

Fig. 15: Relations between grey values in the image and on the screen.

4.2.4 Control points

As described before, the final step within the orientation process will be calculating the relation between image and object co-ordinates, the so-called *exterior*

orientation. For this we will have to measure ground control points, as you will see in the next chapter.

A *ground control point* (GCP) is an object point which is represented in the image and from which the three-dimensional object (terrain) co-ordinates (x, y, z) are known. In our case of aerial photogrammetry, this means that we have to look for points in our image, find these points in a topographic map and get their co-ordinates out of the map, x and y by manual measurement or by digitising, z by interpolating the elevation between neighbouring contours.

If you have a digitiser (tablet), you can use the LISA BASIC programme which supports data input from such a device. Or, you scan the map, import the image file to LISA, geocode it and use the image display of LISA BASIC for on-screen digitising. See the respective manual for detailed advice.

For each image we need at least 3 well-distributed GCPs (or, more exactly, 2 full GCPs x, y, z and one additional height control point, z). A basic rule is “the more, the better” to get a stable over-determination, therefore we shall look for at least 5 points (see also chapter 4.2.6). “Well-distributed” means that a minimum of 3 points should form a triangle, not a line. Furthermore, best accuracy will be achieved in areas surrounded by GCPs. Last but not least it is not necessary but a good idea to use as many identical points as possible in neighbouring images forming a model later.

We can distinguish two kinds of GCPs, called *signalised (targeted)* and *natural* points. Often, before taking the photos, topographic points are signalised on the ground by white bars (size e.g. 1.2 by 0.2 m) forming a cross with the point itself marked with a central “dot” of e.g. 0.2 m diameter (all dimensions depending of course on the photo scale). The corresponding terrain co-ordinates are available from the Land Surveying Office or sometimes from the company taking the photos.

But often we have no signalised GCPs. Then we must look for real object (terrain) points which we can clearly identify in the image as well as in a topographic map mentioned before. But not every point is really good to serve as a GCP: As far as possible, choose rectangle corners (e.g. from buildings) or small circle-shaped points. These have the advantage to be scale-invariant. Take into account that we need also the elevation – this might be a problem using a point on the roof of a building, because it is not possible to get its elevation from the map! Therefore, if possible, prefer points on the ground.

Please remember that points may “move” during time, e.g. when lying on the shore of a river or at the border of a non-paved road. And also remember that the corresponding GCP position in a topographic map may be displaced as a result of map generalisation. Some idea which are good or poor points is shown in figure 16.

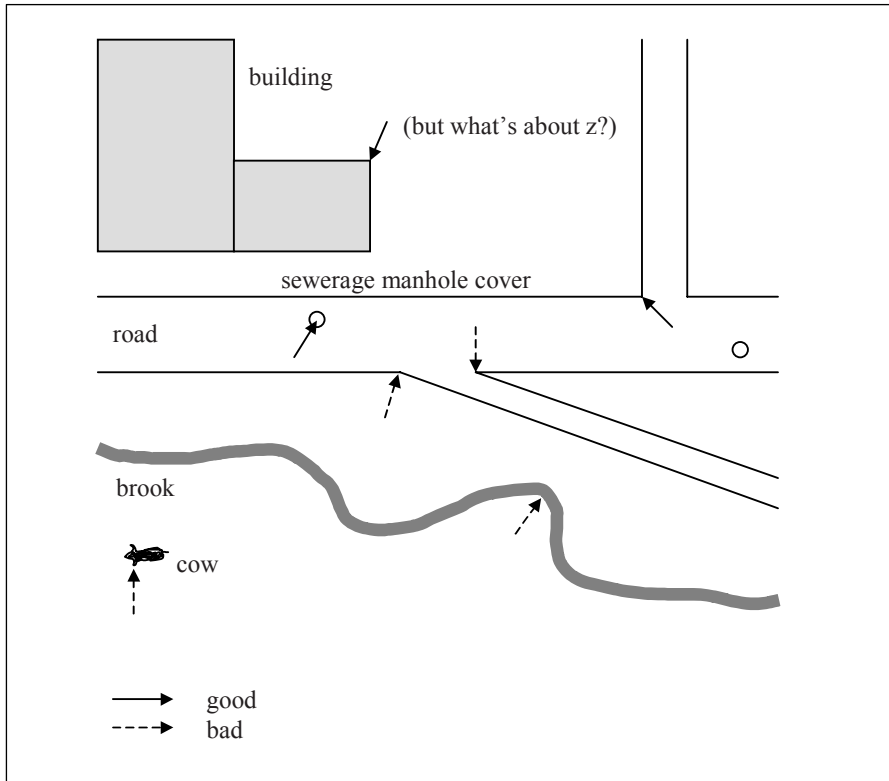

Fig. 16: Examples for natural ground control points.

Nowadays, a powerful alternative to getting co-ordinates from a map is to use GPS equipment (*Global Positioning System*). The advantage is that you can use nearly every terrain point represented in the images and that you have no problems due to map generalisation. The disadvantage is of course that you have to go to your area and, to get really good results, carry out differential measurements (DGPS) with one receiver on a topographic point (*base*) and a second one used in the field at the same time (*field* or *rover*). The problems of “moving” points mentioned before also may occur, the greater the time difference between the dates of taking the images and your GPS campaign. This is not the place to discuss GPS measurements – please use appropriate literature and the equipment’s manual if you want to use this technique.

To prepare the input of GCPs you can use the option Pre programmes > Control point editor. You can open an existing file or create a new one. Using the respective buttons you may edit, add or delete points. With the button Ready you will close and store the file. In this way you can handle a maximum of 900 control points per image.

There are two important aspects concerning the GCP terrain co-ordinates:

- In geodesy, the x axis shows to the north, the y axis to the east in a right-hand system. In photogrammetry, we use a mathematical co-ordinate system definition with x to the east, y to the north in a left-hand system. Whenever you get co-ordinates in form of a listing, labelled “x” and “y”, make sure that this refers to the photogrammetric order! Furthermore, topographic maps of several countries also show the geodetic reference – please take this into account if you want to define the GCP co-ordinates from such maps.
- At all times you create a GCP file, key in the co-ordinates in base units, normally in meters, not in kilometres! This reflects to the kind of storage: All values are stored as real numbers with 3 digits after the decimal point. For instance, if you have a value of let’s say $x = 3250782.023$ and you key in exactly this, the (nominal) accuracy is one millimetre. Imagine you would key in 3250.782023 or in other words you would use the unit kilometre, the software would only use 3250.782 meaning a (nominal) accuracy of only one meter.

4.2.5 Exterior orientation

In our first example, we will use natural control points. In the following two figures you can see their approximate positions. For each point a sketch was prepared as you will see during the measurement.

Before starting, the object co-ordinates from our GCPs must be prepared in a file, each with No., x, y and z in a simple ASCII format. Go to Pre programmes > Control point editor (see above). In the next window use the Add button for each point and key in the following values (the BLUH section is not relevant here):

Point No.	X	Y	Z
15601	1137768.212	969477.156	1211.718
15602	1138541.117	969309.217	1245.574
15603	1139550.021	969249.250	1334.405
15701	1137534.649	970320.150	1251.964
15702	1138573.149	970388.650	1171.448
15703	1139623.149	970359.457	1158.972
15801	1137848.958	971643.004	1142.964
15802	1138601.712	971220.373	1157.148
15803	1139761.651	971315.870	1130.292
15901	1137598.525	972308.940	1128.694
15902	1138667.551	972228.208	1141.743
15903	1139767.051	972325.708	1144.467

After the last point is entered, click on the Ready button and store the file as CONTROL.DAT, then close the window. Or simply load the file from the CD-ROM (...data\tutorial_1\output).

Like for the interior orientation, the exterior orientation must be carried out once for each image. For the first image (No. 157) we will do this together step by step – for the second image (No. 158), again you will do this alone for training purposes. If you have problems with this, as all times you may copy the prepared results from the CD-ROM (...data\tutorial_1\output).

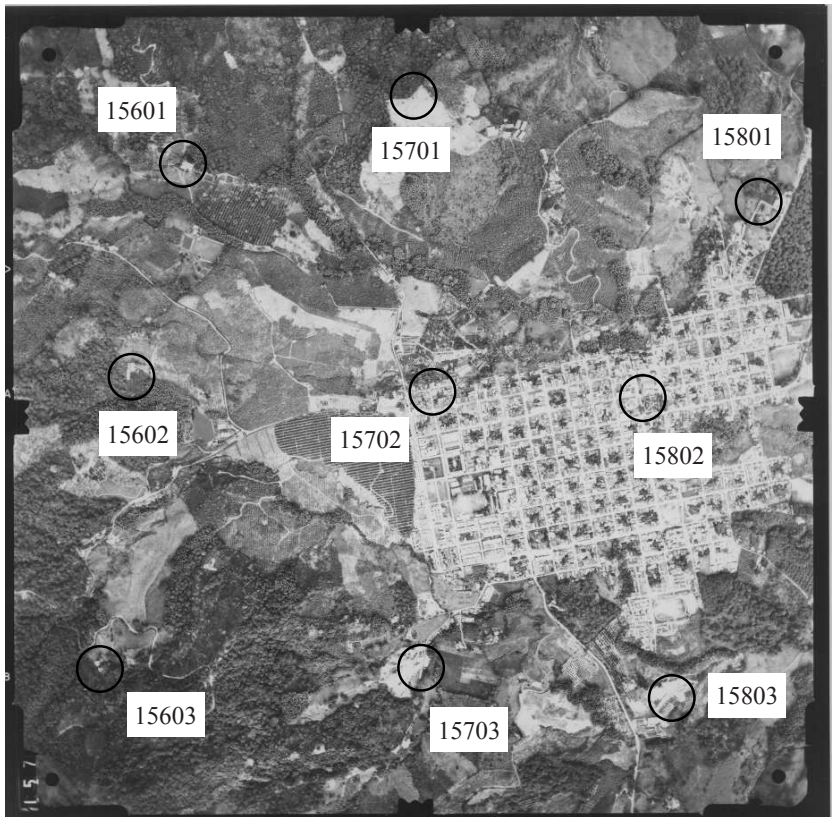

Fig. 17: Positions of the control points in the left image (No. 157)

Please start Pre programmes > Orientation measurement and key in 157 as name of the input image. After loading this file, the measurement interface will appear. Now go to Measure > Exterior orientation. The next window will ask you for the control point file; use the file CONTROL.DAT just created before. The button Reset can (and should here) be used to reset the projection centre co-ordinates to

“unknown” (-999999) if they are already existing. The options Use existing orientation, Create point sketches and Adjust focal length should be de-activated.

Now it is your turn to digitise the control points: You can select a point in the list below – in our case, simply start with the first one, No. 15601. Use figure 17 to find the approximate position of the point. In the small sketch window on the bottom left side of the screen you will see the neighbourhood of the GCP which may help you to find its exact position (this is the already prepared point sketch, see above – a nice tool, but not necessary!). Move the image in the main window with the mouse, middle mouse button depressed, until the GCP lies exactly “under” the measuring mark – you will remember this process from the interior orientation (chapter 4.2.2). Now click onto the left mouse button. The point and its number will be superimposed in the image and marked with M in the list below. In the same way go on point by point until the last one for this image (No. 15803) is measured. If necessary, use the slider at right in the list window to scroll up or down.

After the fourth point is measured, a so-called *resection in space* from object to pixel co-ordinates is calculated by setting up the collinearity equations (see chapter 4.3). As a consequence, for each further point a pre-positioning will be done by the programme and residuals as well as the standard deviation are calculated and shown in the list window.

When the last point was measured, click onto the Ready button and close the window, for example with the Esc key. The results in the list window are stored in the file RESIDU_157.TXT and may be like the following:

No.	x [mm]	y [mm]	Res. x	Res. y
15601	-67.027	71.969	0.024	-0.041 M
15602	-81.847	10.645	-0.063	-0.021 M
15603	-90.674	-73.878	-0.069	0.020 M
15701	0.166	91.835	0.009	-0.047 M
15702	5.048	7.430	0.002	-0.041 M
15703	2.418	-72.617	-0.014	0.053 M
15801	100.316	61.913	0.043	-0.007 M
15802	68.421	4.983	0.048	0.011 M
15803	73.802	-81.715	0.030	0.079 M
Standard deviation [mm]:			0.040	0.042

The residuals in x and y at every point as well as the resulting standard deviation are given in [mm] referring to the image. Remember the scan resolution of 300 dpi = 84,7 μ m to see that the residuals are about half a pixel. In contrary to the results of the interior orientation (chapter 4.2.2) you can see that the residuals are no more symmetric. We have measured 9 well-distributed points, much more than

the minimum (3 points), and therefore a good over-determination is achieved (see next chapter).

For training purposes, please repeat the procedure of this chapter with the second image, 158. Use figure 18 to find the approximate positions of the GCPs. In this image start with point No. 15701. Again, point sketches are already prepared to help you to find the exact position.

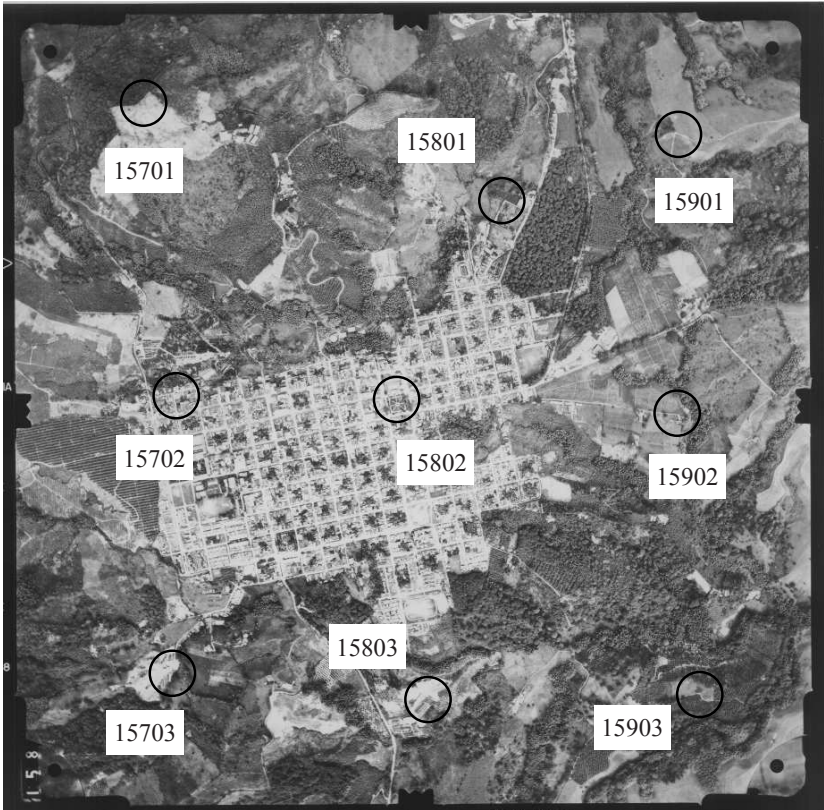

Fig. 18: Positions of the control points in the right image (No. 158)

Created files: CONTROL.DAT, 157.ABS, 158.ABS, RESIDU_157.TXT, RESIDU_158.TXT.

4.2.6 Over-determination and error detection

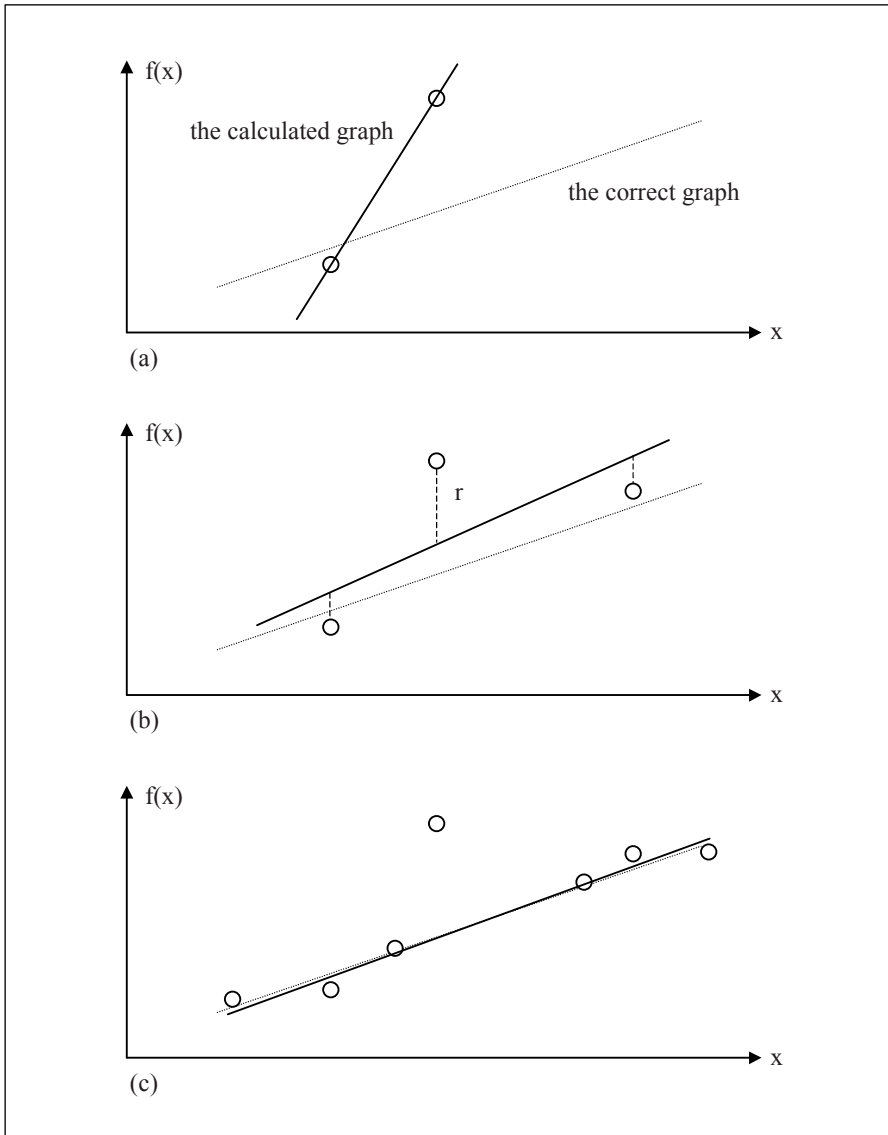

Fig. 19: Calculated versus correct graph of the function $f(x) = ax + b$ using two, three or more observations ($r = \text{residuals}$).

With figure 19 we want to explain the principles of over-determination. Let's imagine that we want to determine the parameters of a one-dimensional linear function, the general form given by $f(x) = ax + b$, by measuring values $f(x)$ at two or more positions of x . Mathematically such a function can unequivocally be fixed by only two points (observations). Part (a) shows this, but you can also see that wrong observations lead to a bad result. Part (b) illustrates an over-determination by three measured points, and as a result, the parameters of the function can be calculated using a least squares adjustment, furthermore the residuals r can be calculated for every point. These gives us an idea about the quality of the observations, but in most cases we cannot decide what point is really bad because the residuals vary not very much. The result is better but not good. Part (c) shows the solution: With seven points we have a very good over-determination, and now it is clear to see that the central observation is wrong (a so-called *peak*). Deleting this, the adjustment gives us a good result.

4.3

Model definition

It is our goal to measure three-dimensional object co-ordinates, as you will remember from chapter 1.1. Therefore all of the following steps will be done simultaneously in two neighbouring images, called the *stereo pair* or the *model* (see chapter 1.9 and figure 9).

Before going on, the particular (actual) model must be defined. Please start Pre programmes > Define model. In the next window please set / control the following parameters:

Left image 157, right image 158, maximum y parallax 3 pxl, correction affine, border size 100 pixels. Exterior orientation: Parameters from ABS files (see chapter 4.2.5), Object co-ordinates CONTROL.DAT. Further, activate the option Test image, then click onto OK.

After a short time, a property sheet window with several information will appear. Before explaining what happened, let's check the data:

Sheet 1 / Co-ordinate range: This is the model area (ranges of x , y and z) calculated by the programme. The values should be more or less like the following:

X from	1137185	to	1140038	
Y from	969875	to	971776	
Z from	1000	to	1700	(all values in [m])

In fact, the elevation range is *not* calculated but taken from the project definition as well as the pixel size (5 m, not displayed here; these values are fixed within the project, see chapter 4.1).

Sheet 2 / Geometry: Pixel size in the digital image, resulting from photo scale and scan resolution, about 1.11 m. Ratio distance/base about 1.99. Maximum attainable accuracy in z, resulting from both values before, about 2.21 m. Photo scale about 1:13229. Please note that all values listed here are only given for control purposes and may differ a bit from those on your computer!

May be you remember the (ideal) value “0.1% of height above ground” (chapter 3.2): The mean flying height is about 3100 m, the mean terrain height is about 1100 m, therefore we have more or less a value of 1%. To save CD-ROM space, our photos were scanned with 300 dpi – if we would have scanned them with 600 dpi, the maximum attainable accuracy in z would be about 0.5% in this example.

Sheet 3 / y-parallaxes: No. of certain points 6, mean y parallax 0.02 pixels, mean window size 15 pixels, mean correlation coefficient 0.924.

Now click onto OK again – the model is defined. But not only this: In between, a lot of calculations and logic tests were carried out, and this is a good place to explain some of them in addition with a bit of theory.

As you will remember from chapter 1.1, 1.7 and figure 1, after the orientation of our two images we have reconstructed the complete geometry. This means that if we have three-dimensional object (terrain) co-ordinates of a point inside of the model area it is possible to calculate the pixel co-ordinates of this point in the left and the right image using the well-known *collinearity equations* (see below). The programme uses this fact in the way that for each point of our control point file CONTROL.DAT a test is made if this point is represented in both images. As a result, the model area can be calculated (section Co-ordinate range).

Collinearity equations (see ALBERTZ & WIGGENHAGEN 2005 for instance)

$$x' = f * \frac{a_{11}(x-x_0)+a_{21}(y-y_0)+a_{31}(z-z_0)}{a_{13}(x-x_0)+a_{23}(y-y_0)+a_{33}(z-z_0)} \quad y' = f * \frac{a_{12}(x-x_0)+a_{22}(y-y_0)+a_{32}(z-z_0)}{a_{13}(x-x_0)+a_{23}(y-y_0)+a_{33}(z-z_0)}$$

with (x, y, z) object co-ordinates, (x₀, y₀, z₀) projection centre, f the focal length and a₁₁, a₁₂, ... the coefficients of the rotation matrix.

4.3.1

By comparing the distances between different points in object and pixel co-ordinates, the mean pixel size of our aerial images in terrain units [m] and the

approximate scale of the original photo are determined. The ratio between flying height and image base (= distance between both projection centres, see figure 1) is an indicator for the maximum attainable accuracy in z , calculated as a product of the first two parameters (section Geometry).

If the orientations of our two images would be exact, then each individual object point within the model area together with both projection centres should form a so-called *epipolar plane* (see figure 1). In particular, this means that the intersection points of the projection rays [object point \rightarrow projection centre \rightarrow film plane] are homologous; there are no y parallaxes. But, as you remember, nothing is exact in real life! And indeed, due to the geometrical situation of the scanner or the CCD sensor of a digital camera, geometrical resolution of the image, errors in the fiducial marks and control point co-ordinates as well as their measurement results and other influences, usually even in a completely oriented model we will have y parallaxes in a range of some pixels. This will be disturbing for viewing, interpretation and automatic processing steps. Therefore, the programme tries to correlate both images in well-known positions taken for example from the control point file. Each position where the correlation fits is called a *certain point* and used for a y parallax correction – at least 3 points are necessary for a (linear) plane affine approach, at least 6 points for a (non-linear) polynomial approach (section y -parallaxes).

The equation systems can be written like following:

$$\begin{aligned} x' &= a_0 + a_1x + a_2y && \text{plane affine transformation} \\ y' &= b_0 + b_1x + b_2y \end{aligned}$$

$$\begin{aligned} x' &= a_0 + a_1x + a_2y + a_3x^2 + a_4xy + a_5y^2 && 2^{\text{nd}} \text{ order polynomial} \\ y' &= b_0 + b_1x + b_2y + b_3x^2 + b_4xy + b_5y^2 \end{aligned}$$

with (x, y) given co-ordinates, (x', y') new co-ordinates and
 $a_0, a_1, \dots, b_0, \dots$ coefficients of the equation system 4.3.2

Now, please remember the activated option Test image (see above). Start the image display (for example using the button Image in the Display menu top right in the main window), open MOD_TEST.IMA and click onto OK. You will see an image showing somewhat like a mounting plate, left and right image mounted in correct relative position (figure 20). May be you know this from the interpretation of paper photos with the help of mirror stereoscopes. The certain points are marked as little white squares, the remaining y parallaxes marked as lines in the left image (error vectors).

Close the display window.

Created files: 157158.MOD, MOD_TEST.IMA

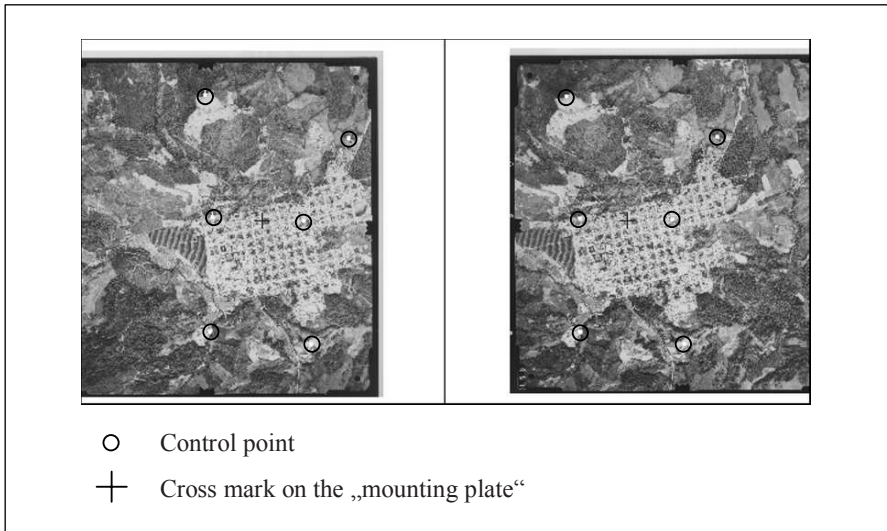

Fig. 20: Test image, model 157 / 158, showing the relative position of the images and the positions of the control points.

4.4 Stereoscopic viewing

From now on we are able to view the model stereoscopically, measure three-dimensional object co-ordinates and digitise objects like points, lines or areas, sometimes called *feature collection*.

Before going on with practical exercises, let's talk about some basics of stereoscopic viewing. May be that you are more familiar with the term "stereo" in association with music: It gives you a spatial impression like sitting in front of an orchestra. The reason is that you receive the sound with *two* ears, sounds coming from the right primarily with your right ear, sounds coming from the left primarily with your left ear. As a result, both acoustic signals are slightly different and are combined in your brain to obtain a spatial impression.

From this well-known experience we can directly go over to stereo vision. We see the world around us with *two* eyes, and due to the fact that they receive the optical information as a central perspective with a distance of about 6.5 cm (about 2.6") between the two images, they are slightly different. These again are combined in our brain to obtain a spatial impression.

This is *one* important reason why we are able to estimate distances. But it is not the only one. Perspective – farther objects seem to be smaller than nearer ones –, experience, background knowledge and more helps us to get a spatial view. May be you know this test: Put a glass of beer on a table in front of you, close one eye, and try to touch the border of the glass with a finger... Repeat the test with both eyes opened (before drinking the beer...).

So far about real life. In our case we would like to see *images* of the real world with the same spatial impression like the world itself. The problem is that to reach this goal we must take care that the left image will only be seen by the left eye, the right image only by the right eye. Once again remember stereo listening: The best way to separate both *channels of acoustic information* is to wear headphones. Analogue to this, the best way to separate both *channels of optic information*, the left and the right image, is to use special optics like a mirror stereoscope to view paper images.

For the stereo vision of digital images there exist a couple of possibilities. For example, the images can be viewed with so-called *shutter spectacles*, having a small LCD screen for each eye. Here, a high speed switching between left and right image on the screen and simultaneously the left and right part of the spectacle will be carried out – at each time, only one glass of the spectacle is switched to opaque. Or, each image is projected separately, one horizontally polarised, the other vertically. In all cases you need special hardware. A very interesting method is to use a special colour coding based on the psychological effect that, for instance, red objects lying in the same plane as blue objects seems to be closer to the viewer. Simple prism spectacles can enhance this effect (see PETRIE et al. 2001, for instance).

A very simple and more than 150 years old method is often used for viewing stereo printings and is also used here. It is called the *anaglyph* method (developed by ROLLMANN, 1853). The idea is to print or display both images overlaid, the right in one base colour (usually red), the left in a complementary base colour (usually green or blue). Wearing a simple spectacle with a red glass left and a green or blue glass right, acting as filters, your left eye will only see the left image, your right eye only the right one. The advantage of this method can be seen in the costs, no special hardware is necessary, and in the fact that several persons can use this cheap method simultaneously. The only disadvantage is that it is nearly impossible to use colour images because colour is used for separation of the two images, as described.

4.5 Measurement of object co-ordinates

Please start Processing > Stereo measurement. Until now, we have no terrain model of our area, and consequently the option with start height is suggested, the start or

initial height here been set by the programme to the mean z value of the height range given in the project definition (ca. 1350 m). Set this value to 1200 m, the mean height of our central area, then click onto OK.

The stereo display appears with a similar look and handling like already known from the orientation measurement. Holding the middle mouse button pressed you can move the model in x and y direction. For rapid movement, you may use the rectangle border (showing the actual position) in the overview image, also with the middle mouse button depressed. In fact, moving the mouse means moving within the *object space*: The programme calculates the intersection points (as described in chapter 4.3) using the collinearity equations and is able to move the images simultaneously. Viewing may be done for both images side by side or using the red-green glasses with the anaglyph method.

You will recognise that the positions “under” the measuring marks for the left and the right image are not exactly identical. The reason is that with exception of our control points we have no height information. Therefore we must set the height manually: Press the right mouse button and move the mouse forward (= increasing z) or backward (= decreasing z) until both measuring marks lies “over” corresponding positions, or use the central mouse wheel. In the status line bottom left on the screen you can pursue the result of your actions by changing the x, y and z values. Eureka!': The main task of photogrammetry is solved!

Attention, theory: If you are a sharp observer you will recognise that, moving the mouse in z direction, not only the z value will change but also the x and y values by small amounts. The reason is that we are moving within the *epipolar plane* (see figure 1) defined by the left and the right projection ray, along a vector from our actual start position x, y, z (terrain) to the middle of both projection centres, and that we have no nadir images.

Obviously, now we are able to measure (digitise, register, collect) the three-dimensional object co-ordinates of every point within our model, a work which is called *feature collection* in more sophisticated software packages. You can imagine a lot of applications for this tool, let's mention only two of them here:

- Cartography and GIS: Digitising roads, rivers, buildings and similar objects and use these data for example within a cartographic or GIS software package.
- Terrain models: Collection of points and morphologic data like break lines, using these data to interpolate a DTM (see chapter 4.6.1).

For both possibilities we want to give a little example here. As you can see on the display, the central part of our model shows the beautiful city of Caicedonia, a typical Spanish founded settlement in Colombia (South America) with a chess-board-shaped ground-plan. Let's digitise some of the housing blocks, called

¹ Greek: I have found it!, © Archimedes, 3rd century before Christ

cuadras (squares), with a surrounding polyline. To do this, choose Digitise > Points / lines from the main menu. In the appearing window set the parameter Code to General lines and the name of the output file to REGIS.DAT, then click onto OK.

Now go near to the first point which should be a corner of a square, using the middle mouse button, set the correct height with the right mouse button pressed down, correct the position and then click onto the left mouse button. Go to the next point, set the height, and so on. Close the polyline with a click onto the Close button right hand in the Digitise menu segment, in this way creating a polygon (= closed polyline). A window appears in which you may change the code (don't do it here) and go to the next polyline with Continue, or finish the measurement with Ready – in the latter case, the programme will inform you about the number of digitised points.

If you want to increase or decrease the moving speed, just click onto one of the Move buttons. The speed can be set for x / y and z movement independently.

You will feel that this kind of digitising is a bit complicated and time-consuming: In more or less any position setting x and y, then correcting the height, fine correction of x and y, in some cases final correction of z ... You will agree: There must be a way to make the work more comfortable. Indeed, there are several ways, and in our next example we will see the first of them:

Choose Digitise > Grid from the main menu. With this option it is possible to digitise a regular grid of points semi-automatically in the way that the x-y-positions are set by the programme, and the user has only to correct the height. In the window you see the proposed area (range of x and y). Please key in the following parameters:

```
X from 1138000 to 1140000
Y from 969900 to 971500
Grid width 250 m
```

Maintain all other parameters, set the output file name again to REGIS.DAT, then click onto OK. May be a warning message “File already exists” appears – in this case click onto Overwrite.

Now the programme sets the images to the first position, given by the minimum x and y values of your grid's border. Set the height using the right mouse key or the central mouse wheel in the same way like in the last example, then click onto the left mouse button. The programme goes automatically to the next position, you just have to set the height and click onto the left mouse key and so on until the last position is reached (= the maximum values of x and y). As you will see it may happen that a position is a bit outside of the model area or that a point cannot be measured, for instance because it is covered by a cloud. Then go to the next position by clicking onto the Skip button in the Digitise menu segment or simply use

the F3 key until the next position is reached where a measurement is possible. Continue until the last point is measured, or click onto Ready to finish this example.

Remark: In any of the measurement windows, you can use Info > Mouse buttons to see the options associated with the mouse buttons and function keys.

Obviously this is a way to make the digitising easier if the goal is to collect regularly-spaced data. Let's keep it in mind to look for more comfort also if we want to digitise individual objects like lines...

More or less all we have done until now is also possible with analytic instruments – of course, they are much more expensive and complicated to handle. But, why not use some of the powerful tools of digital image processing to get even more automatic and comfortable? In the next chapter you will learn something about the possibilities of image correlation (matching). With this step we will enter the field of methods which are typical for digital photogrammetry and not available in (traditional) analytical work.

Created file: REGIS.DAT.

4.6 Creation of DTMs via image matching

4.6.1 Some theory

Please remember what we have done just before: Automatic pre-positioning in x and y , then manually setting the height. We considered the height to be OK just in the moment when the measuring marks were lying exactly “over” corresponding (*homologous*) positions in the left and the right image. If we can find an algorithm telling the computer what we mean saying “corresponding positions”, the programme should be able to do all the work automatically over the whole model area, forming a digital terrain model (DTM).

In general, a DTM can be seen as a digital representation of the terrain, given by a more or less large amount of three-dimensional point co-ordinates (x, y, z). There exist various methods to get these data, one of them we will see in the next chapter. From the input (primary) data, may they be regularly distributed or not, then an area-covering data set (secondary data) is created by interpolation (for instance, see LINDER 1994).

Before going on, this is the moment to remember what kind of elevations we or the programme are able to measure: For each given position (x, y) the uppermost z value and only this! Depending on the land use, this may be directly on the terrain but also on top of a house or a tree. For instance, image parts showing a dense forest will lead to a surface on top of the trees. Therefore, we know two different definitions of elevation models (see figure 21).

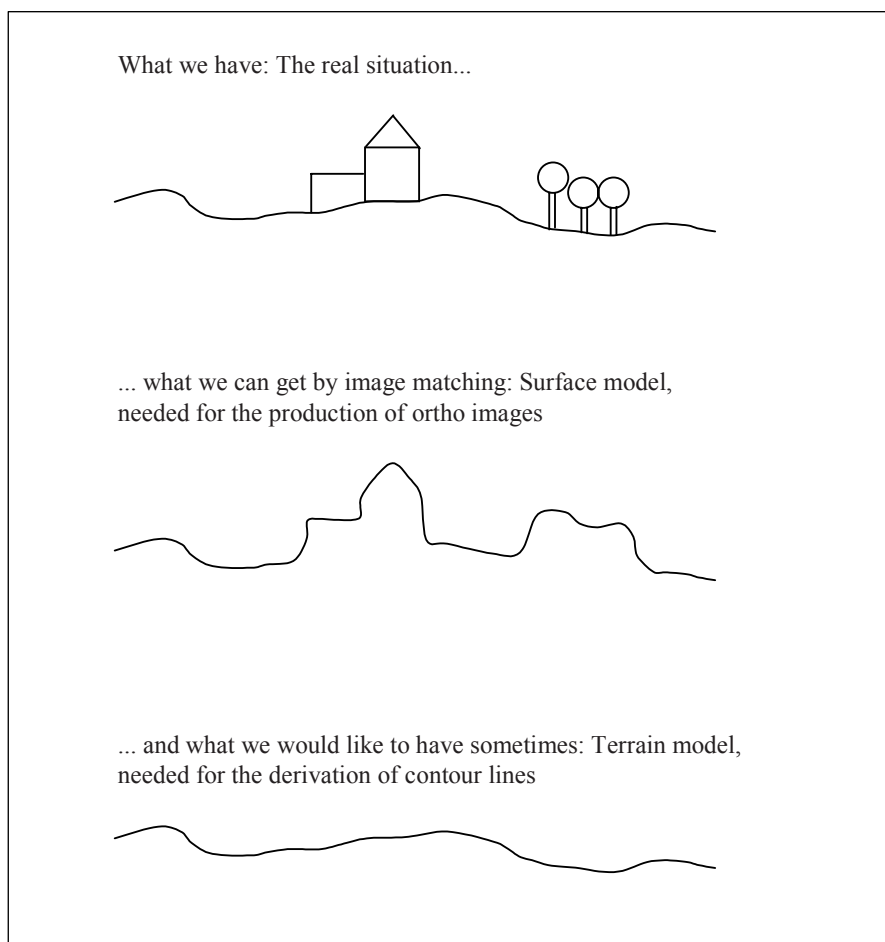

Fig. 21: Situation in the terrain and kinds of digital elevation models

- Digital terrain model (DTM) or sometimes digital elevation model (DEM): Contains z values situated on top of the real terrain (earth). Such a model can be used to derive contour lines.

- Digital situation (or surface) model (DSM): Contains z values at the top of objects situated on the terrain. Such a model is needed when ortho images should be created (see chapter 4.7).

During the past, a lot of efforts have been made developing methods for this. We will use one of them, well-known as *area based matching* (ABM) which in general leads to good results if we have good approximations. To give you an idea about this approach, please take a look at figure 22.

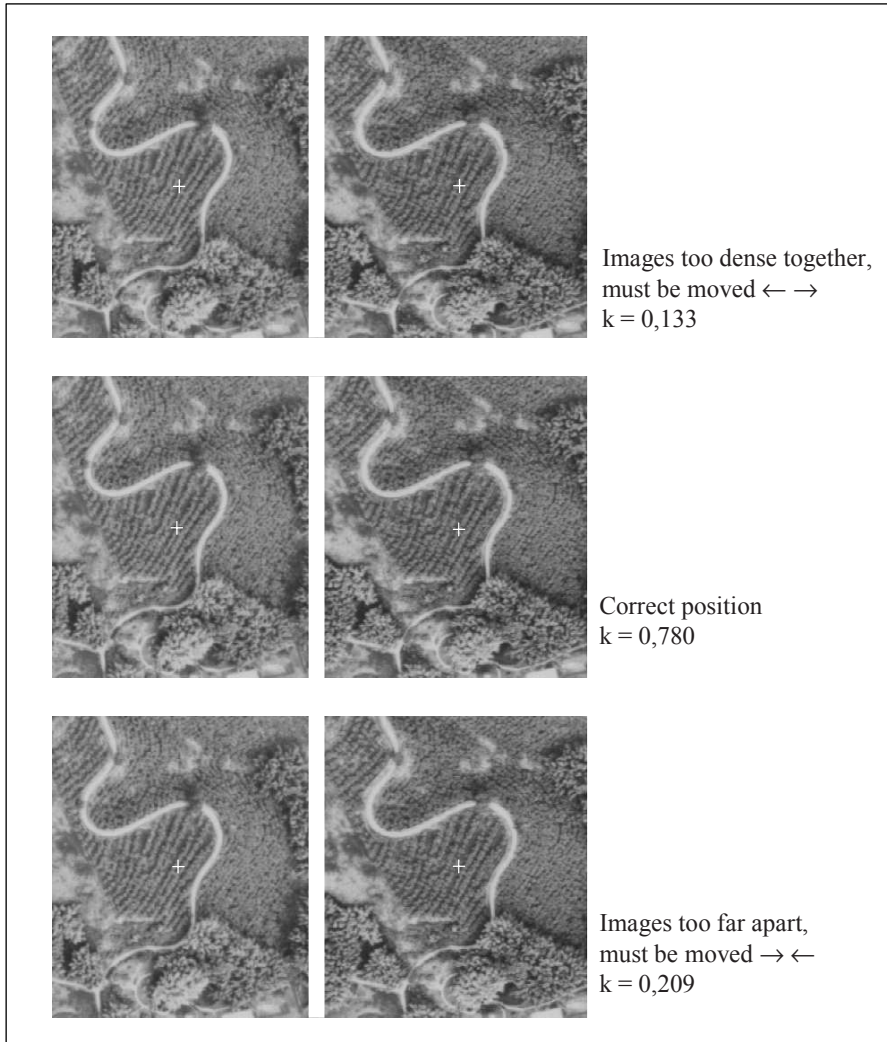

Fig. 22: Relation between image positions and correlation coefficient

The programme compares the neighbourhood of a point in the left image (sometimes called *reference matrix*) with the neighbourhood of the approximate corresponding position in the right image (sometimes called *search matrix*), moving the right position and matrix for a given number of pixels left-right and up-down. In any position a value is calculated giving a measure of correspondence. For this the *correlation coefficient* has been proven to be useful.

As you may know, the absolute value of the correlation coefficient ranges between 0 meaning that both pixel matrices are completely different, and 1 meaning that they are identical. So, the programme will recognise the correct corresponding position by the maximum of all coefficients. For more details about this topic see HANNAH 1988 or HEIPKE 1996, for instance.

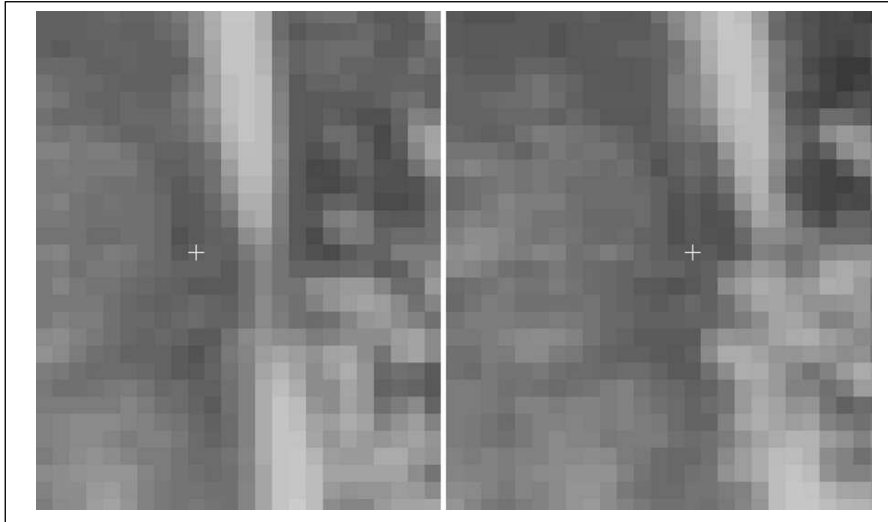

Fig. 23: Parts of the left and the right image, strongly zoomed. The grey values are similar but not identical. Therefore, the correlation coefficient will not be equal but will be near to 1.

The movement of the search matrix, displacing pixels left-right and displacing pixels up-down as mentioned just before, is the standard method in most matching programmes because they are working in the *image space*. The software we use here works in the *object space* as we already have seen before, a technique called *vertical line locus* if we have more or less nadir images (see also figure 1). As a consequence, we have no classical reference or search matrix. The programme simply moves within a given interval along the vector from our actual start position x, y, z (terrain) to the middle of both projection centres (see chapter 4.5), as a consequence the intersection points between the projection rays and the image planes are moving along epipolar lines, and neighbourhoods of the intersection points serve as reference / search matrices.

So far theory was covered. In practise, there may occur a lot of problems due to the fact that the programme has to compare parts of two *different* images showing the *same* object from *different* positions. Besides different brightness and contrast conditions we remember that the relief leads to radial-symmetrical displacements of the objects (see figure 24). As a result, neighbourhoods of corresponding points in neighbouring images are normally not completely identical or, in other words, the correlation coefficient will never reach the value 1. Nevertheless, in areas with good contrast and flat terrain values of more than 0.9 may occur.

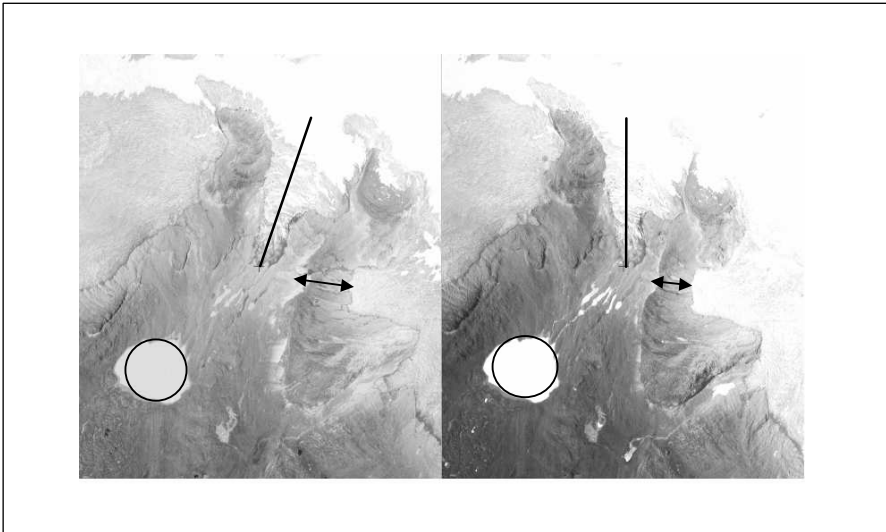

Fig. 24: Displacements caused by the relief, grey value differences from reflections. Area: Nevado de Santa Isabel, Colombia.

On the other hand, in areas with low contrast and / or strong relief like high mountainous regions it can happen that the correlation coefficient will not be higher than 0.3 even in exactly corresponding positions. Concerning the influence of the relief you can imagine that the size and the form of the neighbourhoods to be compared also have an effect on the results: For instance, a smaller matrix will show a smaller influence of the relief. But we cannot establish the rule that smaller matrices are better as we can see looking at a problem known as “repetitive structures” or “self-similarity”:

Imagine a field with crops, let’s say potatoes, usually situated in parallel rows. Depending on the aerial photo’s scale and the scan resolution, a matrix of 21 by 21 pixels may contain two or three rows, and moving the search matrix over the field you will find a lot of similar samples all giving a relatively high correlation coefficient. If we increase the size of the matrices to 51 by 51 pixels we will have a better chance to get the correct result because the programme may find enough small differences (see also figure 22).

As a general rule we can say that large matrices are more stable but less accurate, small matrices are less stable but, *if* the corresponding position is found, more accurate (for instance, see HANNAH 1989, JORDAN / EGGERT / KNEISSL 1972 or MUSTAFFAR & MITCHELL 2001).

4.6.2 Practical tests

Enough of theory for the moment – let’s begin with an example. Please start Processing > Stereo correlation. In the next window control and/or set the following parameters:

Z range ± 5 m, Correlation coefficient 0.8, Correlation window 13 pxl, Iterations 3. Band: red. Resolution 5 m, Interpolation and Subpixel improvement de-activated. Remark: The default value of the resolution (= pixel size) is that defined in our project. Because of the fact that in flat or moderate terrain it is not necessary to match any point for a high resolution DTM it is possible to choose a multiple of the pixel size defined in the project. Then, after correlation the missing values are calculated via interpolation, the correlated pixels in such a method are sometimes called *anchor points*. In our case we take the project resolution of 5 m.

Files: Object co-ordinates CONTROL.DAT, Additional vector data none, Output image (DTM) GITT_TST. IMA, maintain all other parameters as given by default.

Be a bit patient, because this step will need a few minutes. After the approximate DTM is created, you can observe on the screen the results of the improvement as a graphical preview, more and more filled in every iteration.

When the DTM is ready, the programme gives you some statistical information like the following, stored in the file REPORT.TXT:

```

Approxim. DTM .... :          6 sec
Z range +/- ..... :          5.000
Threshold r ..... :          0.800
Window size ..... :          13

Improvement ..... :          41 sec
Z range +/- ..... :          5.000
Threshold r ..... :          0.800
Window size ..... :           7

Correlated ..... :       109208 points
Interpolated ..... :           0 points
Correl. per sec.  :           4266 points

```

Remark: There are no interpolated points because we de-activated the respective option, see above.

Of course, time and speed data depends on the power of your computer and will vary. Close the information window. In the last step the programme now calculates an additional 8-bit image from the DTM.

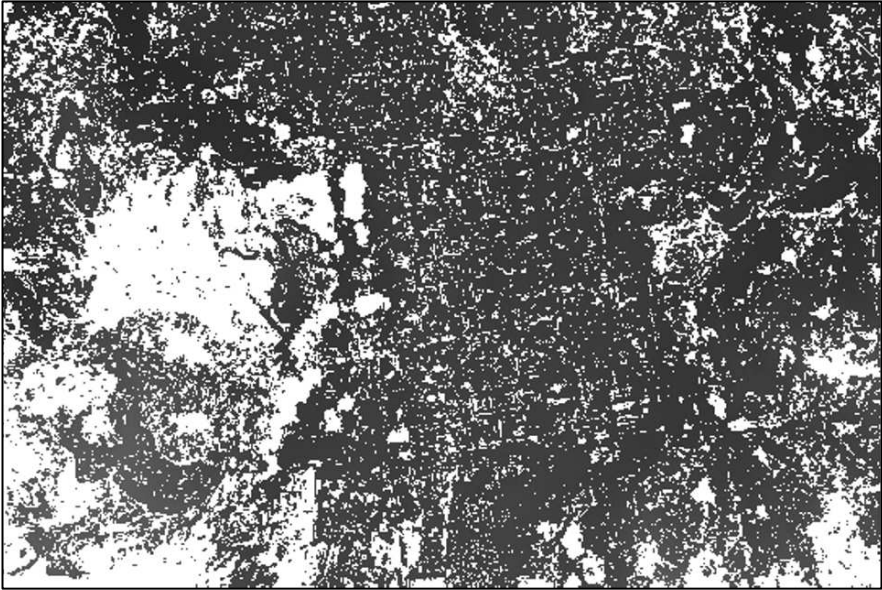

Fig. 25: DTM derived from image matching

Now start the raster display, for instance by clicking onto Image in the Display section right-hand of the main window, and load the image just created (GITT_TST_8BIT.IMA). Choose Palette > Colour 1 to get a better impression of the terrain structures – as you can see, even the streets and buildings of Caicedonia were found by the programme. Most parts of the model area are covered with pixels, nevertheless some gaps are remaining. Please close the display window, for example using the Esc key. The size of the gaps or, in other words, the amount of DTM pixels on which the correlation failed, may be reduced by several methods:

- Increase the z range: But this only makes sense if the terrain is mountainous.
- Decrease the correlation coefficient threshold: We can do this in images with good contrast and low relief influences like here, but be careful in other cases.
- Decrease the size of the correlation window to reduce relief influence (see also chapter 4.6.1).
- Increase the number of iterations.

Which parameter(s) we may change depends on many aspects, for instance the accuracy we want to get – remember our discussion in the last chapter concerning the correlation window size, for instance. Because of the fact that we have moderate terrain and images with good contrast, let's try the following in our case:

Start Processing > Stereo correlation again and change the following parameters with respect to our first attempt: Correlation coefficient 0.7, Correlation window 7 pxl. De-activate Interpolation like before, activate Quality image, maintain all other parameters, set the name of the output file again to GITT_TST.IMA and start the matching process. After the programme is ready, display the 8-bit image GITT_TST_8BIT.IMA on screen – you will see that in more pixels (DTM positions) than before the correlation process was successful.

For a first evaluation of the results, we use the following method: You already know the stereo measurement option – so start Processing > Stereo measurement. In contrary to chapter 4.5, now we have a DTM (GITT_TST.IMA) which is proposed to be used in the first window. Click onto OK.

When the stereo display appears, move a bit inside of the model with the middle mouse button depressed. You can see that in nearly all positions or, specifically, in positions with known height, the corresponding image parts fit together perfectly. In the status line lower left the z value is changed dynamically during the movement according to the DTM position.

Please click onto the DTM button in the overview window (the upper one, showing a small grid) – the DTM area is now marked in red. Further activate Overlay > DTM points from the main menu with the result that all DTM positions are superimposed red-coloured in the left and the right image.

Let's keep in mind that the amount and quality of the correlated points depends on the quality of the images and the image orientations, the correlation coefficient limits, the window size and the number of iterations. We will discuss some more aspects of quality in chapter 4.6.4.

In standard cases, the option Interpolation is active and the gaps are filled. But, for instance, if you have images with larger areas of very low contrast and as a result larger areas with no correlated points but only filled via interpolation, the quality of the final DTM in this areas may not be good. To handle this problem you have the possibility of measuring additional points manually and include them into the DTM before the interpolation of gaps is carried out, as we will see in the next chapter.

Created files: GITT_TST.IMA, GITT_TST_8BIT.IMA, QUALITY.IMA

4.6.3 Additional manual measurements

Stay within the stereo measurement interface, GITT_TST.IMA loaded as DTM. Finish the point overlay with Overlay > New drawing, then go to Digitise > Grid and set the following parameters: Grid width 50 m, Point No. 1, activate the options Only at gap and Square mark, set the name of the output file to ADDI_PNT.DAT, then go on with OK.

In the same way as you may remember from chapter 4.5, the programme will pre-position the images in a 50 by 50 meter grid but only if no elevation is known in the respective DTM position.

Now try to set the correct elevation by moving in z direction with the right mouse button depressed. If in a proposed position you are not able to do this (maybe, the point lies outside the model on the border of an image), use the F3 button to skip the measurement and go to the next position.

Remark: The programme will use the mean project height of 1350 m for the pre-positioning, but this is about 100 m more than the mean height within the model we use at the moment. Therefore, you have to change the height for every point in a large range (from 1350 m to the actual value), and this is not very comfortable. To prevent this, do the following: After you have set the elevation of the first point, activate the Z --- option (z = constant) with the result that the last z value will be maintained when going to the next point.

After the last point is measured, the programme stops giving you information about the number of measured points.

Now you can join the DTM with gaps (raster image) and the file just created (vector data) to obtain a final DTM: Select Processing > DTM interpolation and set the input files: DTM raster image GITT_TST.IMA, vector data ADDI_PNT.DAT, de-activate Only model area, then click onto OK. The result is a DTM without gaps. Again, an additional 8 bit image (GITT_8BIT.IMA) is created which you may display afterwards for control purposes.

This is the moment to remember chapter 4.5, digitising individual objects like lines in the stereo model: We found it not to be efficient that in any point we first had to set the position in x and y, then set the height, correct the position etc. If you like, you may repeat chapter 4.5, using our DTM instead of a (constant) start height in the first window. Now, if you move around in the model or if you digitise points or lines, the height is most always set to the correct value, and it is much easier to collect data. Another possibility will be presented in chapter 4.7.5.

Created files: ADDI_PNT.DAT, GITT.IMA, GITT_8BIT.IMA

4.6.4 Quality control

It would be good to get an idea about the quality of the DTM derived by matching. In general, we must divide between interior and exterior accuracy:

The *interior accuracy* can easily be controlled using the option Processing > Stereo measurement which you already know, loading the model and the DTM, then moving around in the model area and observe the positions of the measuring marks in the left and right image. If they are at all times in homologous positions, the interior accuracy is good – a manual measurement will not lead to better results. Or, use the Overlay > DTM points option and control the points in both images.

As you may remember from chapter 4.6.3, we have created a quality image named QUALITY.IMA. Start the image display and load this image. You will see that the grey values are all in a range between 66 and 99 – if you like, use Palette > Colour 2 to get a better impression. Please note the following: The grey values are set as 100 times the correlation coefficient, therefore, for instance a grey value of 92 indicates a correlation coefficient of 0.92 at this position. If necessary, we can calculate statistics about all values:

Close the display and the FOTO programme, then start LISA BASIC. Go to Management / Analysis > Statistics 8 bit > Grey value statistics, set the name of the input image to QUALITY.IMA. In the appearing window set the following parameters: Grey values from 1 to 255, interval 5, maintain all others. The programme presents the results in an editor window, we will interpret some of them:

```

Minimum value > 0 ..... :          66
Medium > 0 ..... :        87.161
Standard deviation > 0 ... :        9.336
    
```

The minimum correlation coefficient was 0.66, the mean value is 0.87 with a standard deviation of 9.336. Grey values of 0 indicates positions where the correlation failed, and should not be taken into account here.

Range	Area [m ²]	... [%]	S [%]	* = 2%
... 70	140475.000	3.331	3.331	*
... 75	365375.000	8.665	11.997	****
... 80	468475.000	11.110	23.107	*****
... 85	621375.000	14.736	37.843	*****
... 90	817600.000	19.390	57.233	*****
... 95	1064800.000	25.252	82.485	*****
... 100	738525.000	17.515	100.000	*****

Total	4216625.000	100.000
-------	-------------	---------

For most of the DTM positions the correlation coefficient has a value between 0.90 and 0.95 – see the histogram of asterisks right-hand. This is a very good result. The information given here is stored in the file STAT.TXT.

Depending on the quality of the image orientations, nevertheless it is possible that the corresponding terrain (object) co-ordinates are not very accurate. To check this – let’s call it *exterior accuracy* –, there exist several methods.

If you have reference data like terrain points from geodetic or GPS measurements which have not been used as ground control points we may compare their elevations with those found by correlation in the corresponding positions. For this you can use the option Processing > Compare nominal-real in the LISA FOTO module.

In case you have digital contour lines from a different source, for instance from digitising a topographic map, you may use them with the same option. But, be aware of the fact that they are generalised and, very important, show the shape of the real terrain (DTM, not DSM, see chapter 4.6.1)! On the other hand, you can display the DTM from correlation and overlay the contour lines to make a coarse visual control.

Created file: STAT.TXT

4.7 Ortho images

It is a simple thing to geocode or rectify a digital (scanned) topographic map. Just search a few control points (x, y), measure their positions in the map, and use a simple plane affine transformation (you can do this, on-screen or using a digitizer, for instance with LISA BASIC). The reason that such a simple 2D approach leads to good results is the fact that the map was created with a so-called *stereographic projection* where all projection rays are parallel and rectangular (orthogonal) to the projection plane.

But if we want to rectify an aerial image we have to deal with some problems, most of them resulting from the (natural or artificial) relief and the central perspective projection, leading to radial-symmetric displacements (see chapter 1.6). These are pre-requisites for stereoscopic viewing and 3D measurement as we saw before but makes rectification more complicated. The solution is called *ortho photo* or *ortho image*, a representation in the same projection like a topographic map, and again we will start with some basic theory.

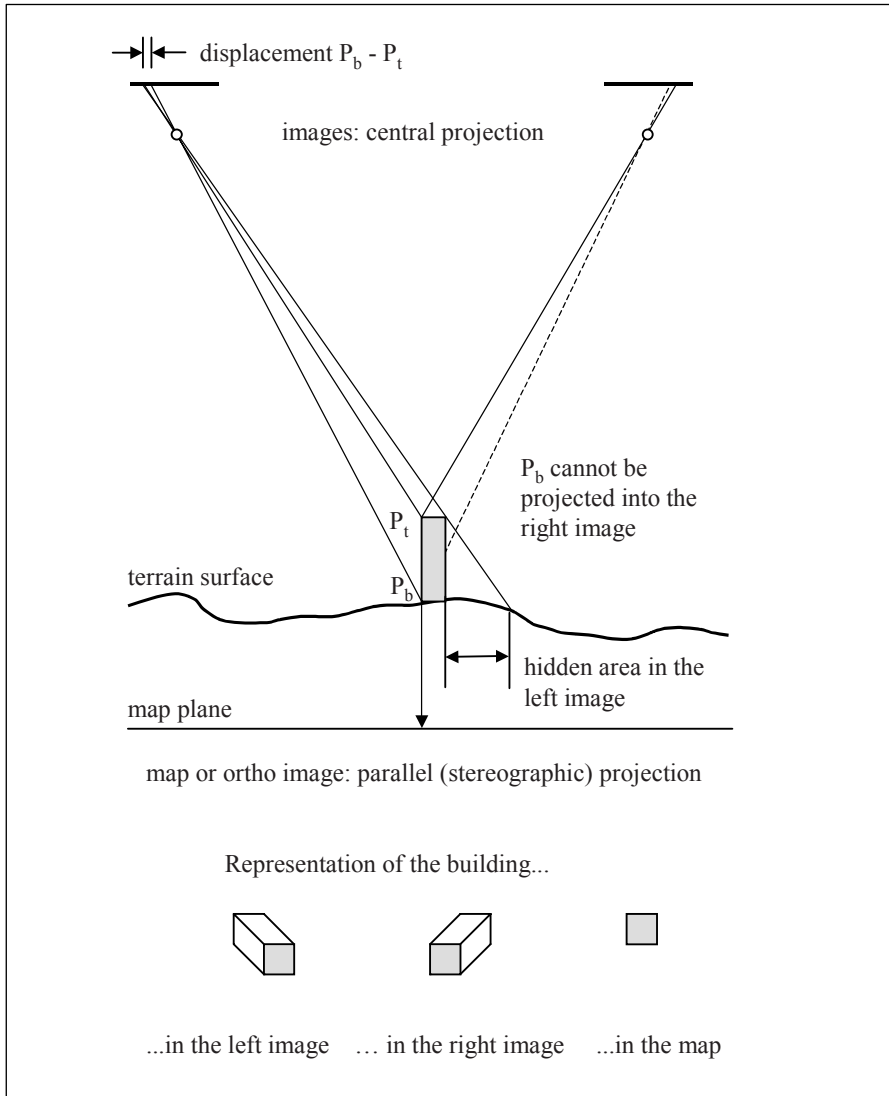

Fig. 26: Central projection (images) and parallel projection (map, ortho image)

4.7.1 Some theory

Please take a look at figure 26. If we have one or more completely oriented image(s) and information about the terrain surface – like our DTM created before –, then the only thing we have to do is to send a ray from each image pixel through

the projection centre down to earth. The intersection of the ray and the terrain surface gives us the correct position of the start pixel in our output image. This process, carried out pixel by pixel, sometimes is called *differential rectification*.

The theory is easy, but even here problems may occur. For example, very steep slopes, may they be natural or artificial (walls of houses etc.), will lead to hidden areas in the image. Obviously this effect increases with stronger relief, greater lens angle and greater distance from the image centre – the effect is not only a hidden area in the image but also a gap in the ortho image. On the other hand, objects situated in or close to the terrain nadir point will have no or nearly no displacement in the image.

There exist several methods to handle the situation. First, we will change the direction of the projection rays: [ortho image → terrain surface → projection centre → image], sometimes called the *indirect resampling method*. By this process we will get a grey value for all ortho image pixels, no gaps will occur. Second, in the case that we have more than one single image (for example a stereo model), we will follow the rule “nearest nadir” which means that we will use *that* image in which the corresponding point of our actual object position is situated as near to the image centre as possible (see MILLER & WALKER 1995, for instance).

Please note that the geometric accuracy of an ortho image is highly dependent on the accuracy of the DTM: Let’s take an object point with its representation near the image border (= far away from the nadir point), the image taken with a wide angle camera, then a height error of dz will lead to a position error of more or less the same size!

To get an optimal accuracy, LISA uses a rigorous pixel-by-pixel method contrary to several other programmes which only calculate the exact position for some regularly spaced anchor points, then filling the gaps with an interpolation.

Therefore you can easily imagine that an optimal rectification must be done with a digital situation model (DSM), and that’s just what we got via stereo correlation.

4.7.2 Resampling methods

Using the rays [ortho image → terrain surface → projection centre → image] like mentioned before, we will find an aerial image pixel when starting within our ortho image. But, as you may imagine, normally the aerial image pixel matrix will not be parallel to the ortho image pixel matrix and the pixel sizes of both images will differ. This leads to the question how to handle the resampling process in particular.

Figure 27 illustrates what we mean. There exist several methods to determine the grey value for the new (ortho) image, and each of them has typical advantages and disadvantages:

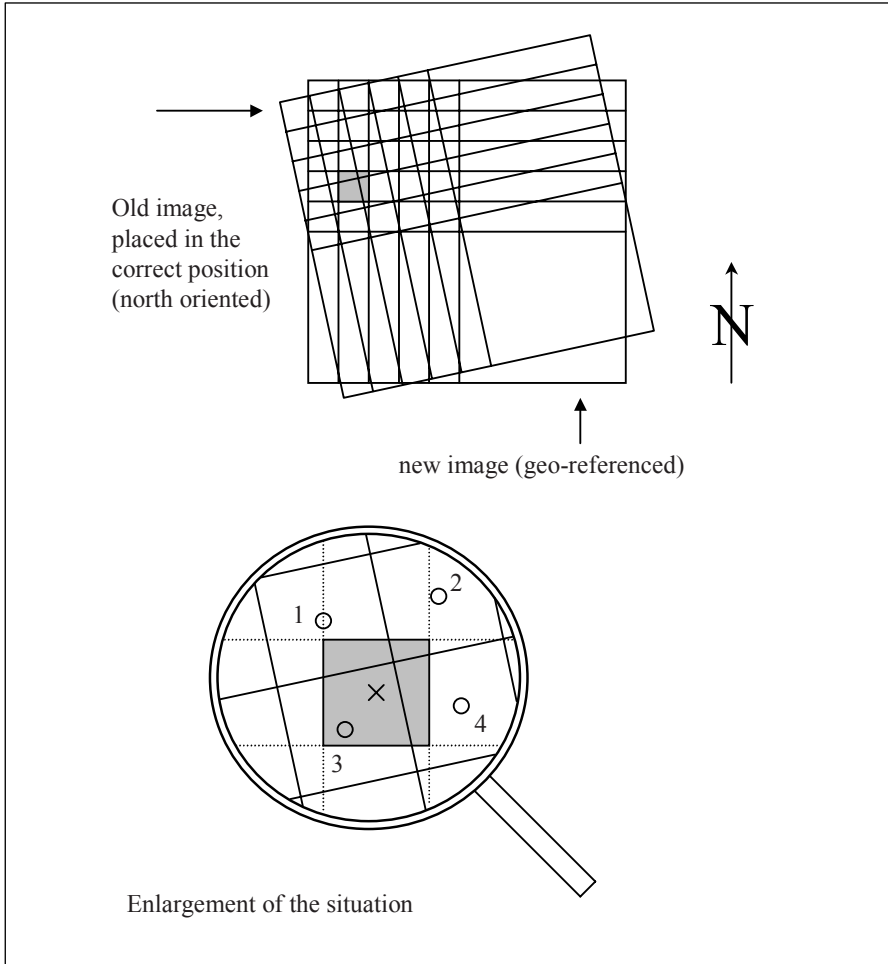

Fig. 27: The resampling problem: Find the grey values for the pixels in the new image

- Nearest neighbour: This method is the fastest one. If the geometric resolution of the aerial images is significantly higher than that of the ortho image, select this option. In our example (figure 27), the ortho image pixel will get the grey value of pixel 3 from the original image.
- Bilinear: This method may be used if the geometric resolution does not differ very much. The bilinear approach calculates the new grey value from 4 pixels

surrounding the intersection point, weighted by the distance from the intersection point (marked with x) to the pixel centres (marked with o). This leads to a “smoother” result, due to the fact that the resampling method has a mean filter effect! Like for every mean filter, the resulting grey values are not identical with the original ones. This must be taken into account if the result should be classified afterwards.

- Cubic convolution: Similar to bilinear, but 16 surrounding pixels are used, leading to a stronger smoothing (and more time for calculation). This method is not offered in our software.

4.7.3

Practical tests

OK, enough of words, let’s start with LISA FOTO again. First we want to make sure that we have a correct DTM without gaps: Go to Processing > Load / change DTM and choose GITT.IMA as the actual DTM. As a standard, the last created / used DTM should be presented as default here.

Then start Processing > Ortho image. The parameter Source gives us three alternatives, Single image (the exception), Actual model (default and our case) or All images which we will use later on (chapter 5.3.3). What about the other parameters?

Only model area: If this is much smaller than the project area you should use this option. If it is de-activated the ortho image is calculated within the project boundaries.

Grey value adjustment: If the same object area is represented in different images it often happens that there are differences in brightness. Sometimes, especially in older photos, you will recognise a brightness decrease near the borders (*vignetting*). So, if we will calculate a mosaic of ortho images we may get sharp brightness changes along the seams which are the “nearest nadir” borders of neighbouring images mentioned before. Using the option described here, the programme will calculate a correction function for every image with which brightness differences will be minimised (figure 28).

Files: Keep the names as they are suggested. As an alternative which we will not use here it is possible to create the ortho image using a horizontal plane (z value constant) instead of a DTM.

Keep all parameters and click onto OK. After the programme has finished, you can take a look onto the result using the image display (see also figure 29).

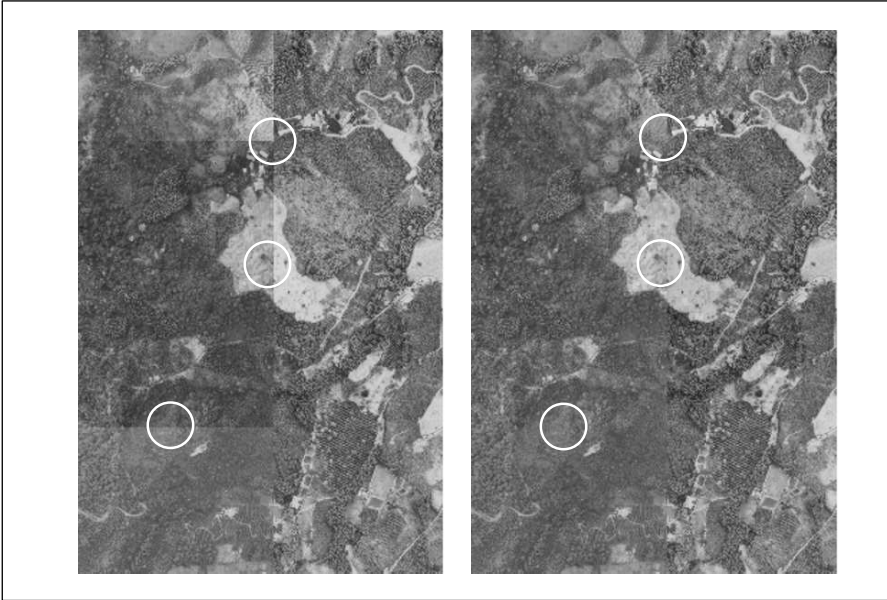

Fig. 28: Effect of the grey value adjustment

Created file: ORTHO.IMA

4.7.4 Creation and overlay of contours

As you may know it is possible to derive contour lines directly from a DTM, and that's what we want to do now. But stop, a short brainstorming will be helpful before: What we have until now from the stereo correlation is not really a DTM but a DSM (see chapter 4.6.1) containing more or less the real surface structure with a lot of peaks like houses, trees and others.

Imagine we will use this to calculate contours, then we will get really a lot of lines running around this peaks, and this is surely not what we want. Contours are always created from DTMs! Therefore we need to filter the DSM with a mean filter. This will not lead to a real DTM but will smooth our DSM – and this is at least more than nothing. In fact, during the past and for instance in connection with DTMs derived from laser scanning, efforts have been made to develop more sophisticated filter strategies (see JACOBSEN 2001 or LOHMANN 2001, for instance).

For this and the contour creation we will use the LISA BASIC module. Please start this programme, then go to Terrain models > Filtering. We will use all options of this tool and the following parameters:

Fill local minima with a window size of 30 pixels, Remove peaks with a tile size of 10 pixels and a threshold of $z = 2$ m and Filter with the method Mean and a window size of 5×5 pixels. Input file is GITT.IMA, output file as suggested GITT_FLT.IMA. De-activate the option Additional 8 bit image, then click onto OK.

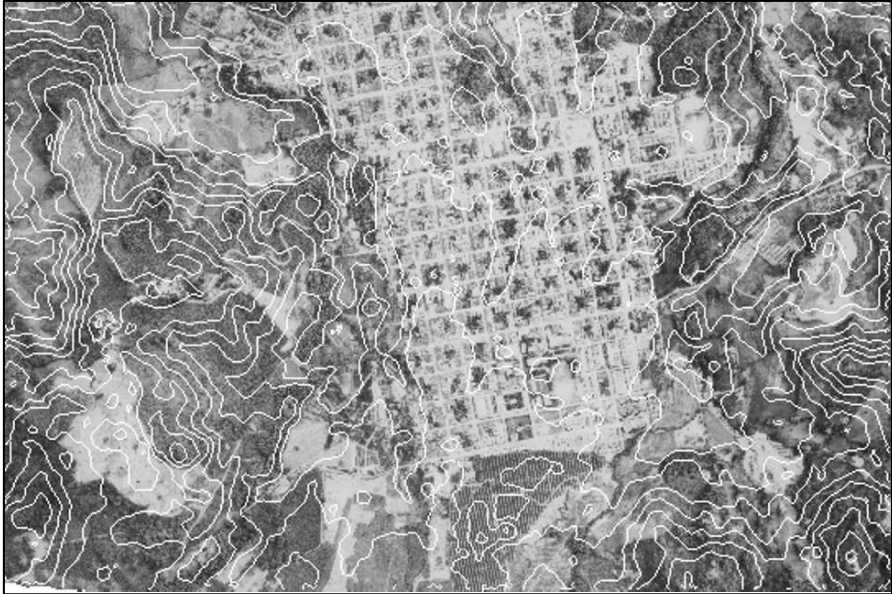

Fig. 29: Ortho image, 10-m contours overlaid

Now start Terrain models > Graphics evaluation > Base image > Contours vector. Set the parameters Equidistance to 10 meters and Tolerance to 1 meter and use as name for the output file CONTOUR.DAT. After OK the programme starts creating the contours in a vector representation, and when this is done, a data reduction procedure (*tunnelling*) will be carried out. A message informs you about the amount of points in the output file – again click onto OK. If you like you can control the result within LISA BASIC using the graphics editor: For example, start this by clicking on the Vector graphics button right in the main window (Display section). Especially when enlarging the graphics you may find several artefacts – as mentioned above, we have no real DTM, and these artefacts result from peaks not completely eliminated by the filtering process.

Stay within the LISA BASIC programme and display the ortho image, then choose Overlay > Vector. Input file is CONTOUR.DAT, overlay colour for instance 255 (white) or 1 (black), as you like. After OK, the contours are shown overlaid to the ortho image (see figure 29).

Created files: GITT_FLT.IMA, CONTOUR.DAT

4.7.5 Simple 3D data collection

We want to remember the topic of data collection (digitising). There is a quite easy way to get three-dimensional data if we have an ortho image and a DTM, and we want to explain it here:

Use again the LISA BASIC module and display the ortho image ORTHO.IMA in the standard image display (Display > Raster image or with the popup menu). Now go to Measure > Digitise > Register, set the name of the output file in the appearing window to REGIS_2D.DAT and the code in the next window to General lines, then OK.

Now you can digitise points and lines very simply in a mono image, just clicking onto the desired positions with the left mouse button and using the Close or End button right-hand in the window to finish a line – see the programme description of LISA BASIC for more details. When you are ready, click onto the Ready button in the window always appearing after Close or End, in the next window onto OK, then close the display.

Until now, we have only collected the x and y co-ordinates of our objects. We can control the results using Display > Text, finding that all z values are set to 1, or using Display > Vector graphics to see a graphical representation.

Now go to File > Export raster image. Choose DAT / vector and set the first input image to our DTM, GITT.IMA, then OK. In the next window choose Single point data and set the name of the output file to REGIS_3D.DAT, again OK. And finally, in the window appearing now the name of the point file must be REGIS_2D.DAT (just created before, only 2D data), click onto OK again. What's going on?

The programme reads the x and y values from the file REGIS_2D.DAT, finds the corresponding position within our DTM and adds the z value to it. Therefore, the output file REGIS_3D.DAT has similar contents like REGIS_2D.DAT, in particular the x and y values are identical, but the z values now give us the DTM heights.

Let's summarise what we have seen during data collection:

- If you have to digitise 3D data from a stereo model, you can do this directly within the stereo measurement option.
- If the amount of data to be digitised is large, it is much more comfortable first to derive the DTM, then loading it into the stereo measurement module to get an automatic setting of the z value in any position.

- It is also possible to create an ortho image from our (original) image(s) and the DTM, then measure data very simply in 2D, after that adding the heights like described above.

And what's the best way? The last method should only be used if the DTM is very precise and/or the heights must not be of high accuracy. Remember that the DTM creation by matching may fail in some areas, for instance due to low contrast – therefore, if you need really good elevation values in all positions, the second method is the better one because you see if points are homologous, and if they are not, you can correct this directly during digitising.

Besides, photogrammetric experiences show that a maximum accuracy of digitising especially concerning the height will be reached in a “real” stereo measurement, for instance using the anaglyph method instead of the side-by-side representation of our images.

Created files: REGIS_2D.DAT, REGIS_3D.DAT

5 Example 2: Aerial triangulation

5.1

Aerial triangulation measurement (ATM)

If LISA FOTO is still running, go to File > Select project and choose the project TUTOR_2.PRJ or, if you have to start LISA FOTO anew, select this project. If necessary, go to File > Edit project and change the path of your working directory (see chapter 4.1).

Within this tutorial we will work again with a ground resolution of 5 m to save time and disk space. Of course, if you have time enough, a strong computer and sufficient storage capacity (RAM and hard disk), you can go to a higher resolution of let's say 2.5 m using the option File > Edit project, changing the pixel size to this value.

5.1.1

Common principles

Remember the exterior orientation in our first example: For both images forming the model we used some ground control points (GCPs) to establish the orientation via a resection in space. To do this we needed at least (!) 3 well distributed points forming a triangle.

Now imagine the case that we have much more than two images, let's say a block formed of 3 strips each containing 7 images as we will use in this example, and we have no signalised points but only a topographic map, scale 1:50,000. Greater parts of our area are covered with forest, so we can only find a few points which we can exactly identify. It may happen that for some images we are not even able to find the minimum of 3 points.

This may serve as a first motivation for that what we want to do now: The idea is to measure points in the images from which we do not know their object coordinates but which will be used to connect the images together. These are called *connection points* or *tie points*. In addition, we will measure GCPs wherever we will find some. Then, we will start an adjustment process to transform all measured points (observations) to the control points. In this way we will only need a

minimum of 3 GCPs for the whole block – it is not necessary to have GCPs in each image. On the other hand, a standard rule is to have one GCP in every 3rd model at least near the borders of the block, and if necessary additional height control points inside of the block (see figure 30).

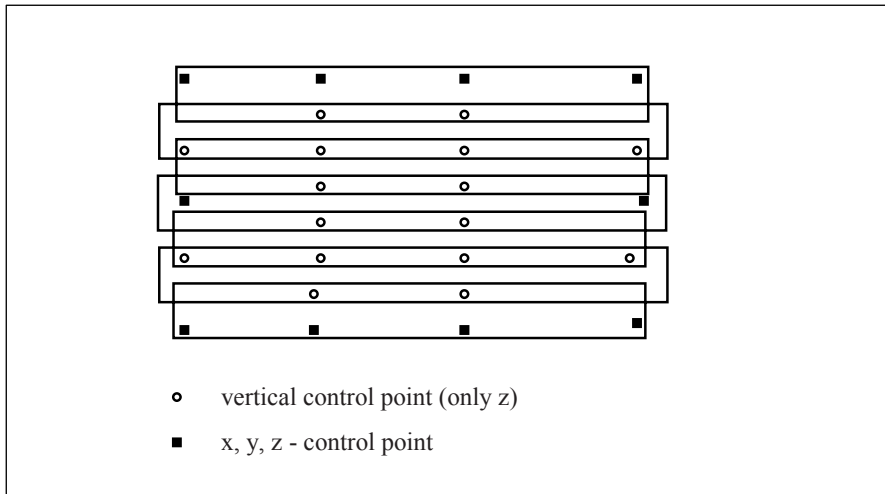

Fig. 30: Proposed positions of control points in the block. From JACOBSEN, 2007.

Maybe you can get a better impression of this with the help of figure 31. All images of a block are connected together using corresponding points, “gluing” them to a mosaic which is then transformed to the GCPs. Of course this two-dimensional scheme is *not* exactly what an aerial triangulation will do – nevertheless, it is very useful to understand the rules we must fulfil in our work. The aerial triangulation, today usually carried out in form of a bundle block adjustment (see chapter 5.2), can be seen as a method to solve an equation system, containing all measured image co-ordinates as well as the GCP terrain co-ordinates.

Remark: After the interior orientation of all images (next step), we will take a look into the principles of manual *aerial triangulation measurement* (ATM) and carry out an example. This is a good possibility to understand the way how ATM works, and is necessary for the measurement of ground control points. Nowadays usually automatic approaches are used, and we will do this in chapter 5.1.8 as well. But even for understanding the problems or errors occurring in the automatic processing it is valuable to know the basics of manual ATM.

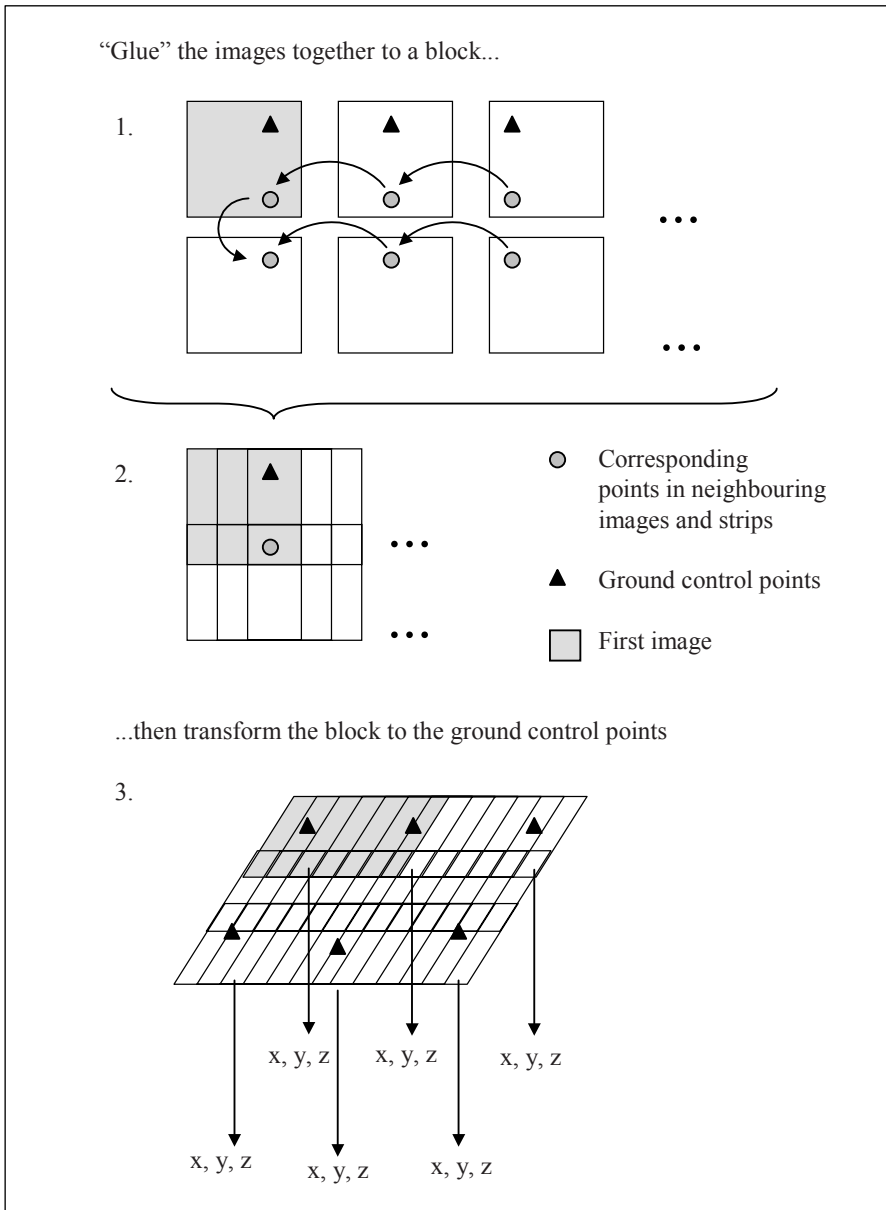

Fig. 31: Scheme of a block adjustment

5.1.2 Interior orientation

Before starting the measurement, we need the interior orientation of all images used in the block. You already know this from our example before – if you want to make it now, please refer to chapter 4.2.2 and take into account that the first two strips, images No. 134 ... 140 and 155 ... 161, are taken in “normal” order whether the last strip, images No. 170 ... 164, were taken when “flying back”. This means that you have to use the option Turn by 180 degrees when starting the interior orientation. The images from our first example are parts of this block, therefore the camera definition is the same as before.

Maybe you will find it easier to use the already prepared files, 134.INN ... 170.INN from the CD-ROM (...data\tutorial_2\output).

5.1.3 Manual measurement

Let's start this chapter with some general rules (see figure 32):

- In any *model*, at least 6 well-distributed object points must be measured. It is an old and good tradition to do this in a distribution like a 6 on a dice, the points are then called *Gruber points* in honour of Otto von Gruber, an Austrian photogrammetrist.
- *Neighbouring models* must have at least 2 common points. In standard, we will use 3 of the Gruber points (the left 3 for the left model, the right 3 for the right model).
- *Neighbouring strips* are connected together with at least one common point per model. As a standard, we will use 2 of the Gruber points (the upper 2 for the upper strip, the lower 2 for the lower strip).
- Each object point must have a unique number. In particular this means that a point has the same number in any image in which it appears. On the other hand, different object points have different numbers.

The first step in practice is the preparation of the images. You should have (or make) paper copies of all images. Put them on a table in the order in which they form the block. Now look for the 6 Gruber points within the first model: This should be done in accordance with the advice given for natural ground control points in chapter 4.2.4. Take into account that the 3 points at right are also represented in the next model to the right, the 3 points at left are also represented in the neighbouring model on the left. Also take into account that the 2 points on the

bottom of the model are represented in the neighbouring strip below of the actual one, the 2 points on the top of the model in the neighbouring strip above the actual strip.

Mark each point in the paper copies for instance with a small coloured circle, and give it a number using a logical scheme: This may be the left image number multiplied with 1000 plus an additional incremental digit. Example: The image number is 134, then you may label the points with 134001, 134002, 134003 and so on. Remember that the stated number of points in the rules are *minimum* values – whenever you find it useful, take more to receive a good connection of images, models and strips.

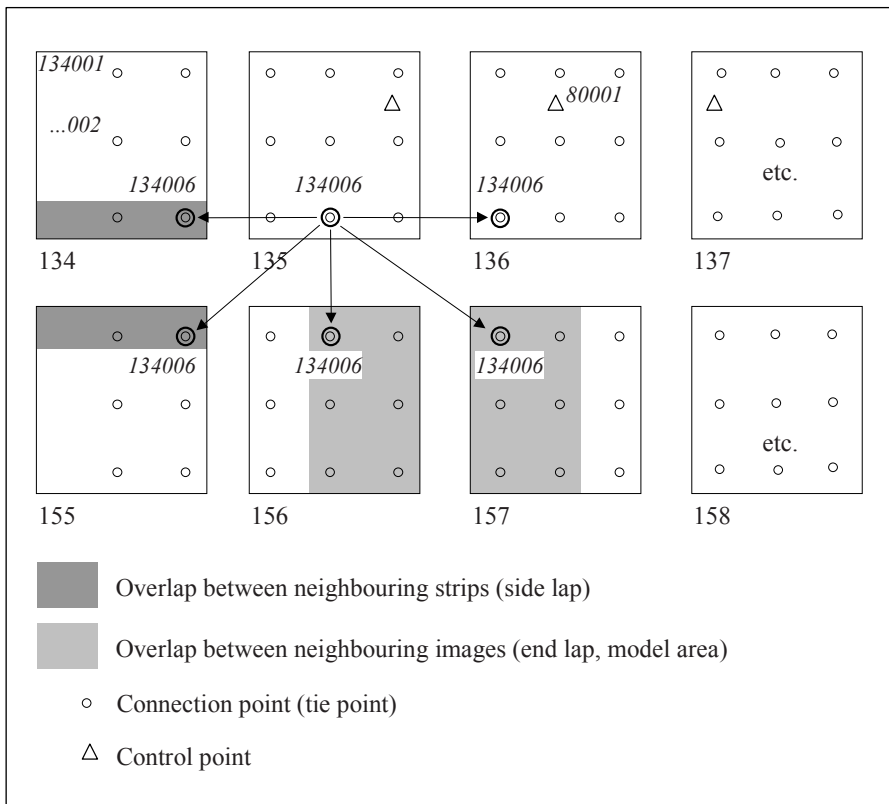



Fig. 32: Principles of point transfer within a block

In the same way mark all existing GCPs, for instance with a small coloured triangle, and give them also a unique number which is different from all others. For example, use the numbers 80001, 80002, 80003 etc.

When everything is prepared, you may begin with the measurement. Start ATM > Manual measurement, key in (or control) the image numbers of our first model in the first (uppermost) strip: Left 134, right 135. Set the approximate End lap (= longitudinal overlap between both images) to 65%, the name of the output file to IMA_COORD.DAT and activate the option Create point sketches. After OK, a stereo display appears similar to that you already know from the stereo measurement. In the same way you can move both images simultaneously with the middle mouse button pressed down. Using the right mouse button instead you can move only the right image while the left is kept in its actual position (this option is sometimes called “fixed photo” in analytic instruments). In this manner it is possible to put both images together with corresponding points. Please do this in the actual position. It might be helpful to zoom out before by clicking once or twice onto the minus magnifying glass button, then bring both images together, after that set the zoom to standard by clicking onto the central zoom button.

Now start Measure > Gruber points. The programme sets both images to the first Gruber position, top left. Hold the middle mouse button pressed, look for a useful position near to the one you are now (for example, a corner of a building), set the desired position in the left image, then hold the right mouse button pressed and do the same for the right image. If the corresponding positions are reached both in the left and the right image, you may use the F2 key to get an improvement by correlation. Then click onto the left mouse button to digitise the point. The programme will give the number 134001 automatically and, after moving the mouse a little, go to the next Gruber position, middle left. Continue the described steps until the last Gruber point (bottom right) is digitised, then click onto the Ready button on the right side of the window and close the display, for instance with Esc.

Again start ATM > Manual measurement. Use the  button to switch to the next model, 135 / 136. The output file name keeps IMA_COORD.DAT as suggested, and again the option Create point sketches should be activated. Attention: After OK, the warning message “File already exists: IMA_COORD.DAT” appears – use the Append button as suggested, *not* the Overwrite one!

When the stereo display is ready you will see the positions of 3 Gruber points coming from the model before marked with small green squares in the overview image. If you move to these positions in the main (stereo) window you can also find them overlaid and labelled in the left image – in analytic photogrammetry this is called *automatic point transfer* –, and of course we will measure these points in our actual model. Besides, 3 new Gruber points in the right part of our model must be measured. It is your decision what you would like to do first.

OK, let's begin with the “old” points marked here. Start Measure > From model before, and the programme sets the actual position to point 134004 (top left). The position within the left image of course cannot be changed, so just correct the position in the right image with right mouse button pressed down. If you like, use again the F2 key to refine the position via correlation. Something is new: In the

small window bottom left on the screen you see a neighbourhood of the point which may help you also to find the correct position in the right image. This was created due to the option Create point sketches we activated. These “sketches”, already known from chapter 4.2.5, are stored in files named in the form <point number>.QLK, for example 134001.QLK (“quicklook”).

After the 3 existing points are measured, start Measure > Gruber points. Now we already have points in the left part of the image, therefore use the F3 key (skip) three times until the Gruber position top right is reached. From this position on continue in the same way like in the last model: Set the point in the left image with the middle mouse button depressed, then set the point in the right image with the right mouse button depressed, optional use F2 to get a fine positioning, then click onto the left mouse button, and so on.

Finish the measurement with a click onto the Ready button, then leave the window. For control purposes, display the output file IMA_COORD.DAT using Display > Text or simply the respective button on the right side of the main window. The results should be more or less like the following:

```

134000135    152.910 RMK_1523.CMR
      1  2752.538  1390.028  2736.462  1389.510
      2  1421.543    54.974  1406.990    54.475
      3    82.058  1381.911    64.985  1376.989
      4  1412.492  2715.526  1392.023  2713.014
134001  1418.000  2563.600    373.000  2562.600
134002  1536.000  1383.000    433.000  1361.000
134003  1471.000    291.400    508.000    249.400
134004  2262.880  2570.600  1335.880  2572.600
134005  2225.880  1477.000  1255.880  1465.000
134006  2383.880    277.400  1515.880    249.400
      -99
135000136    152.910 RMK_1523.CMR
      1  2736.462  1389.510  2739.509  1409.530
      2  1406.990    54.475  1414.581    71.081
      3    64.985  1376.989    68.991  1388.488
      4  1392.023  2713.014  1393.083  2726.904
134004  1335.880  2572.600    490.880  2573.600
134005  1255.880  1465.000    348.880  1465.000
134006  1515.880    249.400    694.880    230.400
135004  2283.600  2507.600  1532.600  2520.600
135005  2359.600  1411.000  1601.600  1411.000
135006  2271.600    224.400  1484.600    196.400
      -99

```

Please note the numbers marked with boxes: Here you can see an example of the automatic point transfer we mentioned above.

In this way you can continue with manual image co-ordinate measurement until the last model of our block is reached.

This is the traditional method, identical to that commonly used in analytic photogrammetry. In the past, a lot of efforts have been made to establish automatic methods which are based on image matching techniques similar to our example for automatic DTM extraction (chapter 4.6). In the next steps we will learn something about this.

Created file: IMA_COORD.DAT

5.1.4

Automatic measurement via image matching: Introduction

A programme which shall measure image co-ordinates for an aerial triangulation automatically has to deal with several goals and/or problems. These are, in increasing difficulty:

- Find homologous points within a single model
- ... in neighbouring models (point transfer)
- ... in neighbouring parallel strips
- ... in lateral strips or images of different scale and/or date

The first two goals can be reached more or less easily. But to connect strips, the programme needs some information about their relative position. One possible way is to define the image centre co-ordinates (for instance with the help of a topographic map), but this may be a problem if you only have small-scale maps, greater areas covered by forest etc.

A different way is to measure some points for connection manually, serving as initial values. For this, we can use a fast and simple way as described in chapter 5.1.7. And, of course we must measure the GCPs manually and with high accuracy – this is what we will do in the next chapter.

5.1.5

Co-ordinate input and measurement of ground control points

As we will see, a huge portion of aerial triangulation measurement can be done automatically. Nevertheless, a few steps remain to be done manually:

- Input of control point object co-ordinates
- Measurement of the ground control points
- Strip definition (chapter 5.1.6)
- Measurement of strip connections (5.1.7)
- ... and then: Automatic measurement of image co-ordinates (5.1.8)



	No. 80001
	134, 135
	$x = 1136080.500$ $y = 968916.500$ $z = 1427.800$
	No. 80002
	134, 135, 136, 155, 156, 157
	$x = 1137755.400$ $y = 969523.500$ $z = 1212.200$
	No. 80003
	136, 137, 138, 139
	$x = 1135875.000$ $y = 971998.000$ $z = 1089.800$
	No. 80004
	136, 137, 138, 157, 158, 159
	$x = 1137860.000$ $y = 971648.000$ $z = 1149.000$
	No. 80005
	139, 140
	$x = 1135318.500$ $y = 974301.400$ $z = 1056.200$
	No. 80006
	138, 139, 140, 160, 161
	$x = 1137369.500$ $y = 973844.200$ $z = 1120.400$

Fig. 33a: Position and terrain co-ordinates of the control points

		No. 80010
	155, 156, 157, 170, 169, 168	
	x = 1139516.400 y = 969242.000 z = 1327.200	
		No. 80011
	157, 158, 159, 168, 167, 166	
	x = 1139925.700 y = 971286.900 z = 1118.800	
		No. 80012
	159, 160, 161, 166, 165, 164	
	x = 1139862.300 y = 973097.900 z = 1108.700	
		No. 80013
	170, 169, 168	
	x = 1141648.200 y = 969138.500 z = 1133.800	
		No. 80014
	166, 165, 164	
	x = 1141901.100 y = 973031.800 z = 1080.900	
		No.
	x =	y =

Fig. 33b: Position and terrain co-ordinates of the control points (continued)

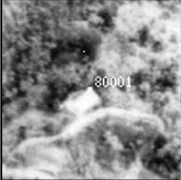
The input of the control point co-ordinates may be done in the way described in chapter 4.2.5. Their values are:

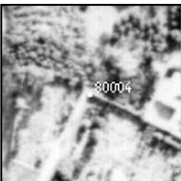
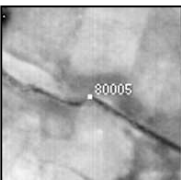
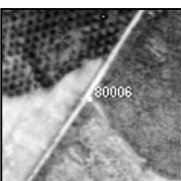
Point No.	X	Y	Z
80001	1136080.500	968916.500	1427.800
80002	1137755.400	969523.500	1212.200
80003	1135875.000	971998.000	1089.800
80004	1137860.000	971648.000	1149.000
80005	1135318.500	974301.400	1056.200
80006	1137369.500	973844.200	1120.400
80010	1139516.400	969242.000	1327.200
80011	1139925.700	971286.900	1118.800
80012	1139862.300	973097.900	1108.700
80013	1141648.200	969138.500	1133.800
80014	1141901.100	973031.800	1080.900

Store the data in a file with the default name CONTROL.DAT, or load this file from the CD-ROM (... \data\tutorial_2\output).

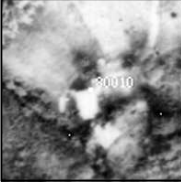
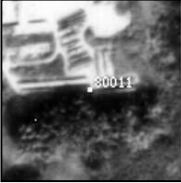
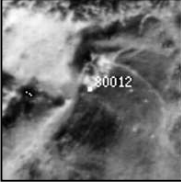
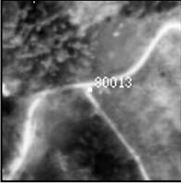
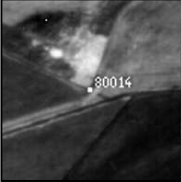
We will continue with the measurement of the control points. For each model which includes one or more GCPs (and, in our case, this is true for all models), start ATM > Manual measurement, key in the image number and the name of the output file, here suggested to be CP_ICOOR.DAT. Click onto the Append button if the message “File already exists” appears. After the display is loaded, go to Measure > Individual and measure the control points in the way described in chapter 5.1.3. Figure 33 a and b inform you about the co-ordinates just stored and the precise position of each point. Use the figures in the Appendix to find the approximate positions of the GCPs.

Created file: CP_ICOOR.DAT

5.1.6 Strip definition

The next step is the definition of the strips in our block, that means giving the first and the last image of each strip. Start Pre programmes > Strip definition. In the appearing, until now empty window click onto the Add button to enter the needed data. In our case, the first and last images are:

134	140
155	161
170	164

After the last strip was defined, click onto the Ready button to store the results.

Created files: STRIP_FOTO.DAT, STRIP_BLUH.DAT.

5.1.7 Measurement of strip connections

The fourth and last preparatory step is to create strip overview images and measure tie points within them: Go to ATM > Calculate strip images. For each strip within the strip definition, an image is created showing all aerial images side by side in a size of 300 by 300 pixels. Their names are ST_134140.IMA, ST_155161.IMA and ST_170164.IMA.

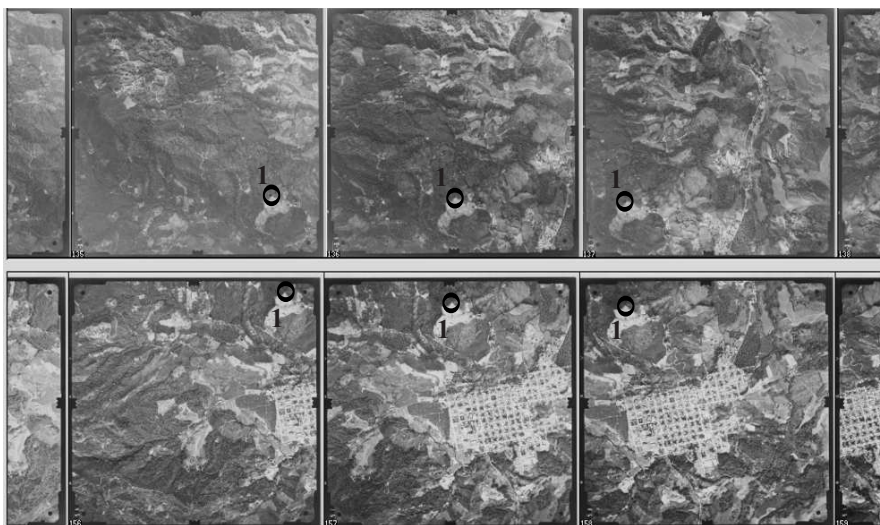

Fig. 34: Part of the graphics interface for the measurement of strip connections. Click with the left mouse button for instance onto the position of point No. 1 in all of the 6 images in which this point is represented, the sequence is without any meaning. Then, after the last position is digitised, click onto the right mouse button to finish this point and to increase the internal point number by 1.

Now start ATM > Measure connections. In the appearing window, load the first strip (ST_134140) into the upper graphics area and the second strip (ST_155161) into the lower one, each time using the drop-down menus on the right side of the window. You can set the brightness for each strip individually, move each strip with the middle mouse button depressed, and go to the first or last image of the strip with a click on one of the arrow buttons.

Some words before about the measurement process: Digitise a point in all images of both strips in which it appears by clicking with the left mouse button, then click onto the right mouse button to finish the measurement for this point, then do the same with the next point and so on. If necessary, move the strips like de-

scribed. The points then are numbered automatically and stored in the output file, default name TIEPOINT.DAT, after clicking onto the Ready / End button.

Concerning the amount and position of the points, you should follow the rules in chapter 5.1.3. In particular, make sure to measure enough points situated in neighbouring strips to establish a good strip connection. As an advice, try to measure at least two points in any model to any neighbouring strip.

The results may look like the following:

777770001	210.000	250.000	134
777770001	115.000	255.000	135
777770001	26.000	254.000	136
777770001	211.000	56.000	155
777770001	121.000	49.000	156
777770001	274.000	272.000	135
777770002	193.000	275.000	136
777770002	98.000	281.000	137
777770002	101.000	95.000	158
777770002	194.000	94.000	157
777770003	139.000	48.000	157
777770003	42.000	53.000	158
777770003	283.000	237.000	136
...			

First column = internal point number, second column = x value, third column = y value (each pixel co-ordinates, measured in the 300 by 300 pixel images), fourth column = image number.

Once again: If you have problems within this step or if you are not sure whether the results are good enough, you may copy the file TIEPOINT.DAT from the CD-ROM, directory ...data\tutorial_2\output.

Created files: ST_134140.IMA, ST_155161.IMA, ST_170164.IMA, TIEPOINT.DAT

5.1.8 Automatic image co-ordinate measurement (AATM)

Now everything is prepared and we can start with the automatic measurement of image co-ordinates, a process sometimes called AATM (*Automatic Aerial Triangulation Measurement*). This will need some time, therefore it is a good idea to prepare a cup of coffee and buy a newspaper to use the time.

Start ATM > Automatic measurement and take a look at the parameters and options in the window. Set the values in the standard deviation section as following:

Image co-ordinates 100 μm , transformation of strips 150 μm , control points in x, y and z each 1 m, activate the option Cut border and set the border size to 100 pixels.

For each model the processing is done in two steps. For the first step (approximation) we use a larger correlation window (17 by 17 pixels) and, if need be, a low threshold value for the correlation coefficient (in our case, use the default one, 0.7). For the second step, the improvement, we select a smaller window (11 by 11 pixels), a higher threshold value of 0.8 and, for both steps, 3 iterations. For the correlation of points which only appear in two (neighbouring) images, the so-called 2-ray-points, we set the threshold value to 0.8. Maintain all file names and click onto OK. Now the coffee should be ready...

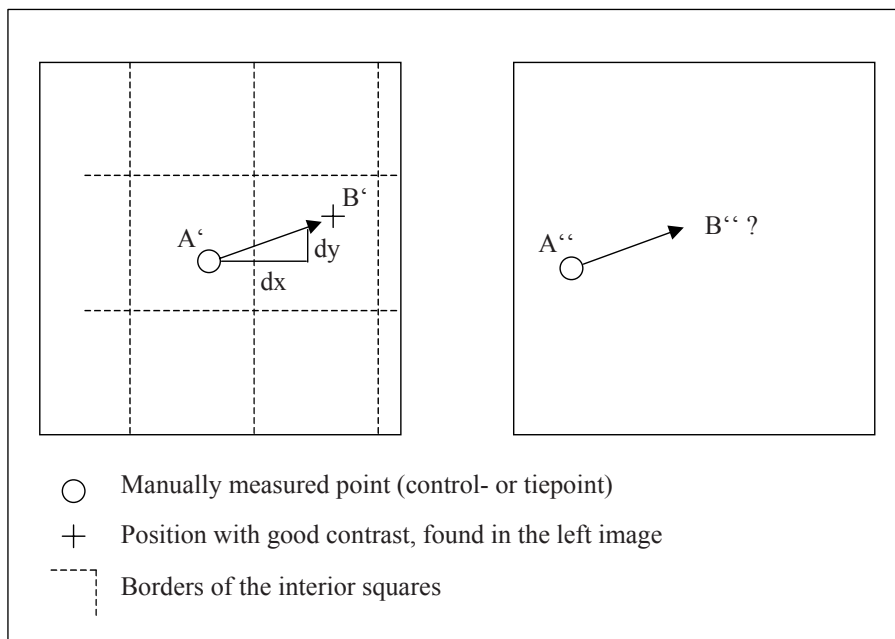

Fig. 35: Automatic search of connection points (tie points) starting with already measured points

Let's use the time for some theory. Internally the images are subdivided into 900 squares – the programme will try to find one point in each square. Depending on the end lap (see chapter 1.9), the maximum number of points can be calculated. For instance, an end lap of 60% we lead to a maximum of 60% from 900 = 540 points. Now remember that we already have several points with known positions in both images: The control points and the points of the strip connection (last chapter). In each of the let's say 540 squares in the left image the programme looks for a position with good contrast. Then, starting with a known point A a trace to point B is followed in the left image, going the same direction in the right image (see figure 35).

During the work, the programme will inform you about the progress in an info window, showing the model, the amount of correlated points within this model and to the model before and other data. All this is stored in the file AATM.TXT which is also finally displayed and may contain information like the following:

```
===== searching connection points =====
```

model	total	prev. model
134135	260	-
135136	299	84
136137	273	171
137138	317	181
138139	279	207
139140	296	180
155156	291	-
156157	291	105
157158	300	152
158159	308	156
159160	264	166
160161	303	121
170169	243	-
169168	263	54
168167	321	114
167166	317	112
166165	321	108
165164	289	107

After this first step is done, using only the manually measured connection points for the strip connection, a two-dimensional transformation to the control points is carried out as a first check. After this, a block adjustment is done using the programme BLOR (part of the software package BLUH, © Dr.-Ing. K. Jacobsen, Hannover), integrated in LISA FOTO. With the results of this adjustment the programme check for every point in which images it may appear – with this method the strip connections then will be improved.

```
===== 3D-adjustment with BLOR =====  
  
strip 1:   6 horizontal,   6 vertical control points  
strip 2:   6 horizontal,   6 vertical control points  
strip 3:   5 horizontal,   5 vertical control points  
  
2D handling of strip   1  
2D handling of strip   2  
2D handling of strip   3  
  
3D handling of strip   1  
3D handling of strip   2  
3D handling of strip   3
```

Beginning with the information from BLOR (adjusted object co-ordinates for each point, parameters of the exterior orientation for each image) the final search for connection points is started. Also this is done in two steps: First in images with reduced resolution which were used until now in all previous work, then finally in the original images (full resolution). This method is known as *image pyramids*.

If everything is finished, another block adjustment is calculated using BLOR again, and as the last step the image co-ordinates found by the programme are converted into the BLUH format, now prepared for high-precision block adjustment (see next chapter).

The results (image co-ordinates) are stored in the file AATM.DAT which has the same structure as the file IMA_COORD.DAT (see chapter 5.1.3.) and in the BLUH format file DAPHO.DAT. The approximate parameters of the exterior orientation calculated by BLOR are stored in AATM_AOR.DAT, the approximate object co-ordinates in AATM_ATC.DAT.

Please note for your own applications that LISA FOTO can only handle parallel strips with images from the same flight (same scale). Until now, lateral strips or images with different scales cannot be processed in the AATM.

Created files: AATM.DAT, AATM.TXT, DAPHO.DAT, AATM_AOR.DAT, AATM_ATC.DAT.

5.2 Block adjustment with BLUH

5.2.1 Introduction

In the next step we will calculate the object (terrain) co-ordinates of all measured image points and also the parameters of the exterior orientation for each image. For this, we will use a so-called *bundle block adjustment* which handles all bundles of rays [object point \rightarrow image point] together in one adjustment process. In our case, we will take the BLUH software package from the University of Hannover, but of course you may use a different programme. For instance, an interface is prepared in LISA to cooperate with BINGO (see chapter 5.2.5).

Some information cited from the BLUH manuals, copied onto your PC (directory c:\lisa\text) during the installation, shall give you a first idea about the methods (see also chapter 7.11.10):

“The bundle block adjustment is the most rigorous and flexible method of block adjustment. The computation with self calibration by additional parameters leads to the most accurate results of any type of block adjustment. Even based on the same photo co-ordinates an independent model block adjustment cannot reach the same quality; this is due to the data reduction by relative orientation, the comparatively inexact handling of systematic image errors and the usual separate computation of the horizontal and the vertical unknowns.

The programme system BLUH is optimised for aerial triangulation but not limited to this. Even close-range photos taken from all directions (with exception of $\omega = 80 \dots 120$ grads) can be handled. A camera calibration for close-range applications is possible even with special optics like a fisheye lens. Also panoramic photos can be handled in the adjustment.

Special possibilities for the controlled or automatic elimination of a greater number of blunders like it occurs in AATM are included.

The programme system is subdivided into several modules to ensure a flexible handling. For computation of a bundle block adjustment only the modules BLOR, BLAPP, BLIM and BLUH are necessary, they can be handled as one unique set or separately. The other modules can be used for special conditions, for analysis of the data and for other support of the data handling” (JACOBSEN 2007).

The principle of bundle block adjustment is based on the collinearity equations, a method to calculate the orientation parameters from ground control points and their positions in the image (see also chapter 4.3). All point measurements as well

as all available control point co-ordinates are handled simultaneously in one single adjustment process which gives the guarantee of high precision results.

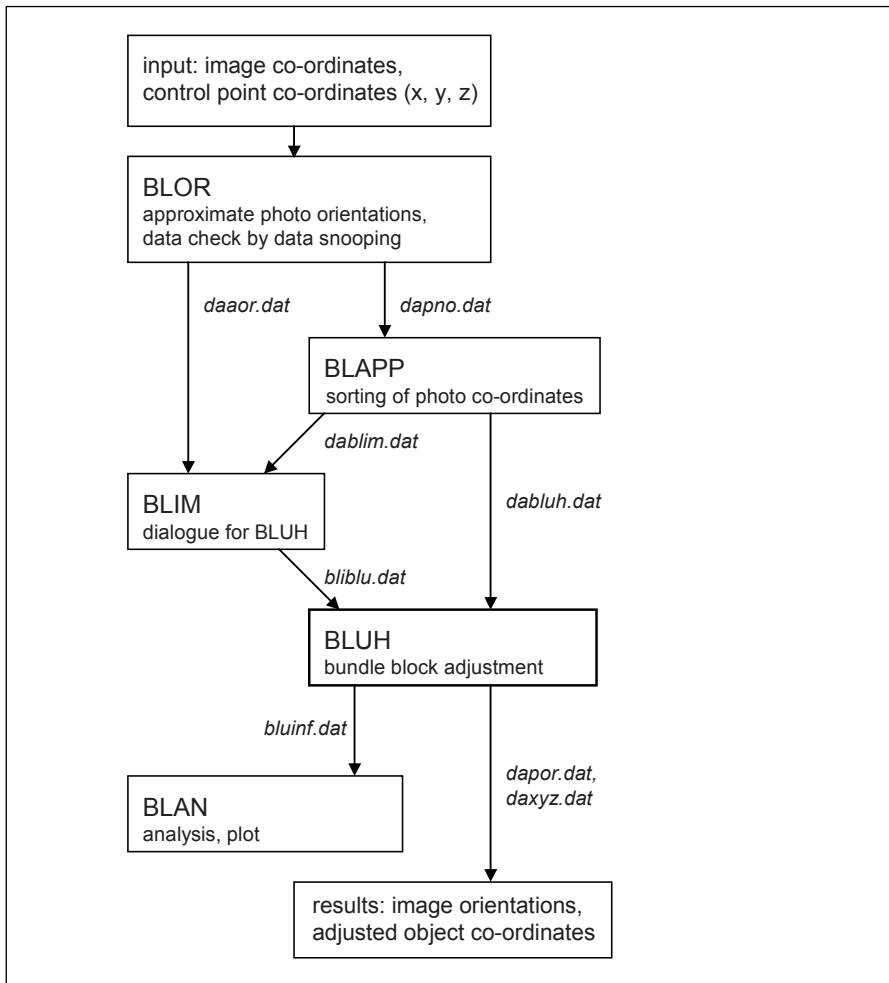

Fig. 36: Workflow and interchange files in BLUH. Simplified from JACOBSEN, 2007.

5.2.2 Running the block adjustment

Please start the programme BLUH_WIN and use the same project like before. The graphics interface is similar to that of LISA, therefore you should not have general problems. The following text will inform you about the single steps and the parameter settings for the main BLUH modules BLOR (Pre 1), BLAPP (Pre 2) and

BLIM / BLUH (Main; see figure 36). In the following chapter we will discuss the results.

Select Block adjustment > Pre 1 (BLOR). Check the following parameters:

Photo co-ordinates DAPHO.DAT, Control points CONTROL.DAT, below that line activate the option Control points. For the arrangement of the photos in the strips activate the option automatic. The last two lines (file names) remain empty. Normally, all these parameters should already be selected when starting this part of BLUH. Now click onto OK.

Next window: Maintain all parameters as they are in the section Parameters. Some information about the standard deviations: For the image co-ordinates we can start with a value between 1 and 2 pixels. Remember our scan resolution of 300 dpi which produce pixels of about 84.7 μm size, so key in a value of 100 μm . For the transformation of the strips a value of about 2 pixels is a good start, therefore set it to 150 μm . And finally, the values for the control points depend on their approximate accuracy concerning the terrain co-ordinates and on the accuracy of the measurements. The image pixel size is about 1.2 m, the terrain co-ordinates have an accuracy of approximately ± 2 m, so set both values to 2 m.

Within this first module, BLOR, a check on large errors (blunders) will be carried out using a method called *data snooping*. As a result, an internal file of detected errors is created (DACOR.DAT). Based on this file, we can create an error correction file for an automatic elimination of incorrect measurements in the following modules. The errors are internally classified with asterisks from * = small error to **** = large error. In correspondence to this, the user can set the range of automatic elimination independently for three classes of points (control p., tie p. and others). We suggest to activate the correction option for each of these groups and select the range as following: Control points '****' (delete only large errors), tie points '***' (a medium value to establish a sufficient strip connection) and '*' for all other points (delete even small errors). Because of the fact that we have a really large amount of points in each image we can use '*' for all other points – of course, many of them will be eliminated now, but we have more than enough. This is a typical setting for error correction when points are found via AATM.

After clicking onto the OK button, for a short time a black (DOS) window will appear, then the results are shown in the editor window. Please close this.

Created file: BLOR.LST, DACOR.DAT

Now select Block adjustment > Pre 2 (BLAPP). Check the following parameters:

Error correction list: Activate this option – the file name should be DACOR.DAT (see above). Maintain all other parameters, click onto OK and close the results shown in the editor window like before.

Created file: BLAPP.LST

And finally select Block adjustment > Main (BLUH). Again please check or select the following options:

Control points CONTROL.DAT, Approximate photo orientations DAAOR.DAT, GPS/IMU positions remains empty, Photo orientations (output) DAPOR.DAT, Object co-ordinates (output) DAXYZ.DAT. In the section Parameters set Listing of residuals to 100 µm, Warnings in iteration to 100 mm, maintain all other parameters in this section. Finally, set the standard deviations of the photo co-ordinates to 100 µm and those of the control points to 2 m each in x, y and z. Click onto OK.

Created files: BLIM.LST, BLUH.LST, DAPOR.DAT, DAXYZ.DAT

All protocol information and results of BLUH are stored in simple text files, the protocols in files of the form <module name>.LST, for instance BLOR.LST, the final results in the file DAXYZ.DAT (adjusted object point co-ordinates) and DAPOR.DAT (orientation parameters of all images in the block). If you like you may open a file using the popup menu (right mouse key) or just by clicking onto the Text button right side in the main window to open the text editor.

5.2.3 Discussion of the results

Let's begin with the results of the first modules, BLOR. Please open the file BLOR.LST and take a look at some of the text which may be more or less like the following:

```
NUMBER OF POINTS PER PHOTO
=====
134 190    135 457    136 629    137 763    138 784
139 708    140 428    155 198    156 464    157 653
158 706    159 679    160 559    161 315    164 301
165 520    166 611    167 634    168 561    169 376
170 158
```

For each image of the block, the number of points is listed, ranging from 185 to 784 in this example.

Strip by strip, in the next section errors found by the programme are listed. The particular values may vary from those on your computer due to your manually measured tie points and other influences but will look similar to the following:

```
RELATIVE ORIENTATION MODEL 139 140 SIGMA0 = 103.12 µm
446 POINTS    BX = .. BY = .. BZ = ..
```

```

PHIR = ..   OMEGAR = .. GRADS   KAPPAR = ..

MODEL      139      140
POINT NO.  XL   YL   XR   YR   Y-PARALLAX   W   R   NABLA
139003      ..   ..   ..   ..       -1202.2   ..   ..   ..
139071      ..   ..   ..   ..       -579.8   ..   ..   ..
139084      ..   ..   ..   ..       -858.4   ..   ..   ..
139265      ..   ..   ..   ..        331.2   ..   ..   ..

RELATIVE ORIENTATION:
POINT  139003 DELETED FROM           139           140      ***

```

(To save space, only the point No. and the y parallaxes are listed here). Depending on the y parallaxes, a check was made to detect bad points. From all points in the model, containing in total 446 points, the worst ones are listed, and you can easily see that point No. 139003 is surely not correct. Therefore the programme suggests to eliminate this point. The option Error correction which we activated in the parameters setting leads to an automatic elimination in the following BLUH modules (BLAPP, BLUH).

Near to the end of the list, you will see something like this:

```

ARRANGEMENT OF PHOTO NUMBERS, INTERNAL CAMERA NUMBERS
=====
STRIP  1:   134 1   135 1   136 1   137 1   138 1
           139 1   140 1
STRIP  2:   155 1   156 1   157 1   158 1   159 1
           160 1   161 1
STRIP  3:   164 1   165 1   166 1   167 1   168 1
           169 1   170 1

```

```

18 MODELS, MEAN NUMBER OF POINTS 354, MEAN SIGMA OF
REL. OR. 88.9

```

The programme sets up the strips (image number, internal camera number; the latter one all times equal 1, because all photos were taken with the same camera). In this example, the mean number of points per image is 354, the mean sigma naught (σ_0 , standard deviation of unit weight) of the relative orientation is 88.9 μm .

Further information is given, for instance the approximate values of the absolute orientation of each image, a photo number list and a final listing of the located blunders (errors).

Please close the file BLOR.LST and open the file BLAPP.LST, created from the second module. At the beginning, the error correction is listed, for instance:

134065	0	134	135	1
134066	0	134	135	1
136007	0	137	138	1
137388	0	137	138	1
137098	0	138	139	1
139003	0	139	140	1
139084	0	139	140	1
139071	0	139	140	1
...				

This list was prepared by the automatic error correction in BLOR. The next listing reports whether the correction was successful:

134065	IN MODEL	134	135	REMOVED BY ERROR CORR.	LIST
134066	IN MODEL	134	135	REMOVED BY ERROR CORR.	LIST
136007	IN MODEL	137	138	REMOVED BY ERROR CORR.	LIST
137388	IN MODEL	137	138	REMOVED BY ERROR CORR.	LIST
137098	IN MODEL	138	139	REMOVED BY ERROR CORR.	LIST
139003	IN MODEL	139	140	REMOVED BY ERROR CORR.	LIST
139071	IN MODEL	139	140	REMOVED BY ERROR CORR.	LIST
...					

Again, a list of numbers of points per photo follows:

NUMBER OF POINTS PER PHOTO									
=====									
134	190	135	457	136	629	137	762	138	783
139	708	140	428	155	197	156	461	157	651
158	704	159	678	160	558	161	314	164	301
165	517	166	609	167	633	168	560	169	376
170	157								
IN PHOTO	170	157	POINTS =	LOWEST	NUMBER				
IN PHOTO	138	783	POINTS =	HIGHEST	NUMBER				

As you can see, the amount of points differs slightly from the list above. This is due to the eliminated points in the error correction process. Nevertheless, we still have between 157 and 783 points per image – much more than necessary (9). A similar listing follows, showing a statistic of the number of photos in which a single point was measured. For instance:

NUMBER OF PHOTOS/OBJECT POINT						
PHOTOS/POINT	1	2	3	4	5	6
POINTS:	0	1690	1846	88	145	113

Most of the points are determined in only two (1690) or three (1846) neighbouring images. Points that occur in more than 3 images, in one single strip or in neighbouring strips, are not so many.

Now please close the file BLAPP.LST and open the file BLUH.LST, created from the last (main) module. After some statistical information and the list of control points you will see something like the following (here shortened a bit):

NO. ITER	MS CORR X	MS CORR Y	MS CORR Z	SIGMA 0 [microns]
=====				
0	.334863E+02	.748947E+01	.247178E+02	3469.9
1	.345870E+01	.249954E+01	.162938E+02	120.0
2	.172475E+00	.363416E-01	.410919E+00	119.9

The last column is of special interest, showing the σ_0 , changing from iteration to iteration. As already mentioned before, this value is the standard deviation of weight unit and can be seen in case of bundle block adjustment as standard deviation of the accuracy of image co-ordinates. In the parameter setting (see above) we defined a maximum of 10 iterations, but, if no more significant improvement of σ_0 is reached, the process terminates.

The next two listings show the standard deviations of photo orientations and the photo orientations themselves, also stored in the file DAPOR.DAT.

Once again remember the scan resolution of 300 dpi or about 84.7 μm . A final result of more or less one pixel can be seen as sufficiently good. Nevertheless, this is only a standard deviation value, therefore let's take a look at the following results in the file. For the maximum of object points the remaining errors (residuals) are less than the limit for listing defined above (200 μm). But some few points show larger errors – this may look like the following:

168489	1141900.239	970948.637	1142.801	3	
D.I.	168	429.1	-50.6	-37.2	-430.4 *
D.I.	167	-863.7	5.5	-2.2	863.8 ***
D.I.	166	429.7	20.7	29.6	-429.2 *

The amount of asterisks right-hand symbolises the size of the error. In our example you can see that point No. 168489 was found during the AATM in the images No. 168, 167 and 166. In image 167 there is a greater displacement in x, the values given in μm . As you know, we have many more points than necessary,

so we will simply delete points with large errors completely. A bit more complicated is a situation like the next:

777770009	1137445.050	969699.794	1294.659	6
D.I.	134	67.3	362.9	-362.8 67.5 *
D.I.	155	1155.3	-208.1	205.9 1155.7 ****
D.I.	135	-12.1	298.3	-298.4 -9.9
D.I.	156	-386.9	-368.9	370.3 -385.6 *
D.I.	136	-224.8	369.7	-370.6 -223.5 *
D.I.	157	-574.2	-373.9	375.8 -572.9 **

As you can see from the point number as well as from the image numbers, this is a connection point (strip 1 and 2). These points are very important for the strip connection and should not be deleted in total if ever possible. From the residuals we can recognise that the only really bad point is in image 155, therefore we will only delete this measurement.

At the end of the listing, the final result of σ_0 is given:

OBSERVATIONS	UNKNOWN	REDUNDANCE	SIGMA 0
			=====
21379	11772	9607	119.95
			[microns]

After this, the adjusted co-ordinates of all points are given, also stored in the file DAXYZ.DAT.

Now, how to do an error correction? Of course we can delete the respective lines directly in our object co-ordinate file AATM.DAT or in the export file DAPHO.DAT created from it, but this will be too much work. Remember that in the parameter setting we had an active option Error correction which makes the module BLOR to create an error correction file named DACOR.DAT. Please open this file which contains entries like this:

136080	0	137	138	1
138205	0	137	138	1
134693	0	155	156	1
136387	0	156	157	1
136342	0	156	157	1
777770006	0	156	157	1
777770006	0	157	158	1
137342	0	158	159	1
160317	0	159	160	1
...				

The sequence of the entries is:

Old point number, new point number, left image, right image, activation flag (0 = de-active, 1 = active for a flexible handling).

You have the following options:

- If the new point number is zero, the point is deleted in this model (left and right image).
- If only the left or the right image number is greater than zero, the point is only deleted in that image.
- If both image numbers are zero, the point is deleted in the whole block.

With this information, you can edit this file using a simple ASCII editor, for example click onto the ASCII button right-hand in the main window. The only thing you must take into account is that the entries must be arranged in the way that the old point numbers (column 1) are in increasing order!

So, if we want to delete the two examples of bad points mentioned before using this file, we have to add the following two lines:

```

168489          0          0          0    1
777770009      0          155        0    1

```

In this way, point 168489 is deleted completely, point 777770009 is deleted only in image 155. Attention: Before starting the block adjustment a second time, remember that as a standard the first module, BLOR (Pre 1), will overwrite our error correction file! To prevent this, don't run BLOR again but start with BLAPP (Pre 2)!

Now, the results of BLUH should be slightly better. If you like you can check the file BLUH.LST again and add more lines to the error correction list.

5.2.4 Additional analysis of the results

After the block adjustment with BLUH is finished, we want to analyse the results and create an image, showing us for instance the positions of object and tie points. Use Post processing > Analysis or just click onto the respective button right-hand in the main window. Set the following parameters: Distance for neighbouring points 1 m, all others remain as before. After OK and a short time, the results are presented in an editor window. Let's again take a look at them.

In a first section, the control points are listed and the ranges of image and terrain co-ordinates are given. Then, neighbouring (and possibly identical) points are listed:

NEIGHBOURED OR IDENTICAL POINTS

=====

		DX	DY	DZ	HOR	DIST
134345	135204	-.675	.086	-.829		.680
137055	138044	.103	.394	-.167		.407
137349	138294	.439	-.079	-.932		.446
138286	139304	.209	.098	-.667		.231
157319	158310	.124	.077	.817		.146
158248	159230	.119	.221	.536		.251
159234	160246	.143	.070	-.325		.159
159284	166016	-.617	-.638	.223		.888
167261	168302	-.687	.040	.443		.688

The programme looks for points within a defined distance (separately in x / y and z) and lists all found point pairs. It is the user's turn to decide whether they are in fact identical.

A special comment should be given to points which appear in neighbouring strips like 159284 and 166016 (8th line). The horizontal distance is 0.888 m, and concerning the photo scale and the scan resolution leading to a pixel size of approximately 1.2 m in the aerial images, we can see that both points have a distance of less than one pixel. Therefore it is possible to unite the points, improving the strip connection in this way. We can do this also in the error correction list DACOR.DAT from before by including the following line:

```
159284      166016      0      0      1
```

Now, if you would run the modules BLAPP and BLUH again, point No. 159284 will be renamed to 166016. The next listing:

DIFFERENCES OF GROUND COORDINATES

=====

CONTROL POINTS USED AS CHECK POINTS

ANALYSED DATA FILE: C:\STEREO\CAICE\BLUINF.DAT

POINT	X	Y	Z	PH/P	DX	DY	DZ	DS
80001	2	-2.066	.056	-.820	2.067
80002	6	-1.055	-.220	-.854	1.078
80003	4	-1.246	.077	-.671	1.248
80004	6	-.677	.830	1.025	1.071
80005	2	-.887	-.097	-1.008	.892
80006	5	1.357	-.857	.343	1.605
80010	5	1.785	.578	.331	1.876

80011	6	.169	.304	-.660	.348
80012	6	-1.074	.076	.403	1.077
80013	3	.723	-.949	1.603	1.193
80014	3	3.265	-.690	-2.201	3.337

SQUARE MEAN OF DIFFERENCES

SX = +/- 1.525 SY = +/- .548 SZ = +/- 1.051 SS =
 +/- 1.620
 NX = 11 NY = 11 NZ = 11

MAXIMAL DIFFERENCES

MAX DX = 3.265 MAX DY = -.949 MAX DZ = -2.201 MAX
 DS = 3.337

SYSTEMATIC DIFFERENCES

SYSTX = .027 SYSTY = -.081 SYSTZ = -.228

SQUARE MEAN OF DIFF. WITHOUT SYSTEMATIC DIFFERENCES

SX = +/- 1.524 SY = +/- .542 SZ = +/- 1.026

(To save space, the values of x, y and z of the control points are not printed here). As we can see, there are no extreme errors in the control point data.

NUMBER OF PHOTOS / OBJECT POINT

PHOTOS/POINT	2	3	4	5	6
POINTS:	1690	1846	88	145	113

In chapter 5.2.3 we already discussed this information.

After closing the window, a vector graphics (format HP-GL) is created which shows all information we have selected: Image numbers and area covered by each image, control points and error vectors in x / y and z, and further all connection points. The last ones are colour-coded to show the number of images in which they have been found (blue = 2, green = 3, cyan = 4, red = 5, magenta = 6 or more).

Figures 37 and 38 show two examples of the graphics output, the first for control and tie points (option Photo location in the Graphics section is set to "no"), the second for the representation of the areas covered by each image (option Points set to "no").

Remark: If you prefer a raster image instead of a vector graphics you can use the option ATM > BLUH graphics in LISA FOTO (see chapter 7.8.10).

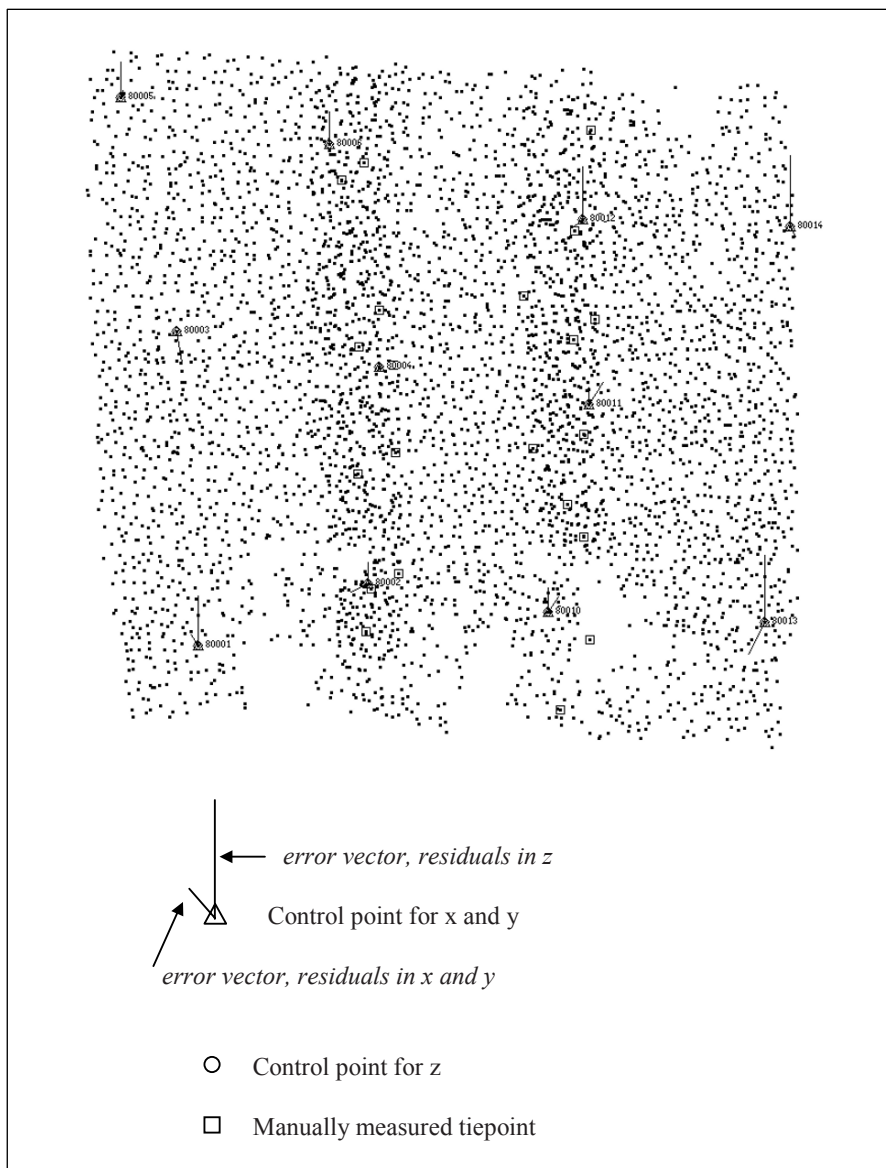

Fig. 37: Distribution of control and tie points

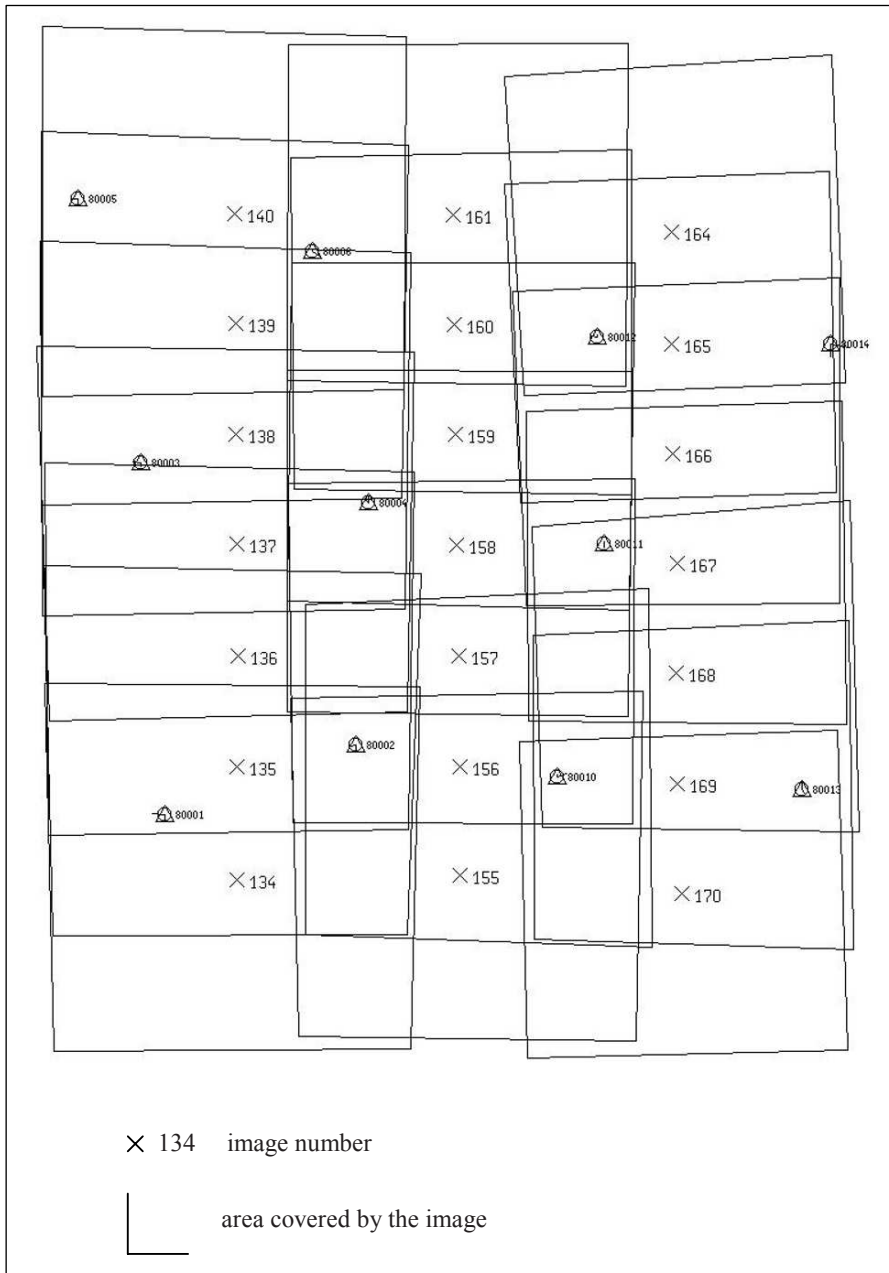

Fig. 38: Area covered by each image

5.2.5

Block adjustment with other programmes: Example BINGO

There exist several other block adjustment programmes on the market like BINGO or PAT-B, and if you have such a software and want to use it instead of BLUH, you must look what kind of formats are needed there. Within LISA, options are prepared to use the programme BINGO. For this, just use the option ATM > Export > BINGO after the triangulation measurement is finished, the input file name is again AATM.DAT (see chapter 5.1.8).

Contrary to the export for BLUH you have to define also the file with control point co-ordinates, in our case CONTROL.DAT. Three files will be created then: IMAGE.DAT containing the image co-ordinates, further PROJECT.DAT (project definition) and GEOIN.DAT (parameter file, control point co-ordinates etc.). Now, close LISA FOTO and start the BINGO manager. Go to File > Select project and use the directory tree to go to the directory of our current project – this may be c:\lisa\tutorial_2.

Because all parameters are already prepared by LISA, you can go directly to Run > RELAX, after that to Run > BINGO and finally to Run > SKIP. May be, an additional improvement can be reached using the Run > Cycle process. But, be careful: There may be a lot of uncontrolled skipping of points! Therefore, before starting the Cycle process it is a good idea to look into the input file IMAGE.DAT where all automatically skipped points are now marked with S in front of the corresponding line. Skipping of a point can be de-activated by removing the S. In particular be careful with the skipping of control points and manually measured tie points (= point No. 77777001 and higher, see chapter 5.1.7)! Make sure that all large errors are removed or corrected in the input file IMAGE.DAT, then start the Cycle process. For details see the BINGO manual (KRUCK 2003). The results are stored in the file ITERA.DAT, protocol information in the files RELAX.LIS and BINGO.LIS.

To use the results from BINGO (adjusted object co-ordinates, image orientations) in LISA, just take the Pre programmes > Parameters of exterior orientation > from BINGO option in LISA FOTO.

Remark: All created files have the formats used in BINGO version 5 or higher.

Created files: IMAGE.DAT, PROJECT.DAT, GEOIN.DAT, ITERA.DAT, RELAX.LIS, BINGO.LIS, SKIP.DAT.

5.3 Mosaics of DTMs and ortho images

5.3.1 Model definition

In the same way as known from our first example, for every model which we want to use in the following steps, a model definition must be carried out before. Go to Pre programmes > Define model and control / set the parameters: Activate all (to make the model definition for all models in batch mode). Within the exterior orientation section, choose Parameters from BLUH / BINGO and set the files to DAPOR.DAT (orientations) and DAXYZ.DAT (object co-ordinates). These are the results from BLUH as you will remember (chapter 5.2.2).

After OK, you will be informed about the progress in an info window.

Created files: 134135.MOD, 135136.MOD, ...

5.3.2 Creation of a DTM mosaic

Now the whole block is prepared for further processing – we have a large amount of object points / co-ordinates as well as the parameters of the exterior orientation of all images. In the same way as we did before it is possible to create DTMs and ortho images from each model, one after the other, and when the last model is processed we should be able to match the DTMs and also the ortho images together to mosaics.

But, as you already have seen in some examples before, it is nice if we can do the work automatically model by model in a batch mode, and this is also possible here. Let's start with the creation of all DTMs and finally put them together into a mosaic. But beware – this is *really* a time-consuming process, so it is a good idea to start before lunch ... and after lunch, there is even time enough to drink another cup of coffee.

Start Processing > Stereo correlation, activate the two options above in the window, All models and Create mosaic, maintain all other parameters, then click onto OK. Model by model, the programme will create a DTM file with a name like GT_<left image, right image>.IMA, for instance GT_134135.IMA when the first model, 134 / 135, is at work. Finally, all these files are matched together to the output file GITT.IMA. In between, an info window informs you about the progress of correlation.

After the programme has terminated, you can display the additionally created 8-bit image GITT_8BIT.IMA (see also figure 39).

Created files: GT_*.IMA, GITT.IMA, GITT_8BIT.IMA

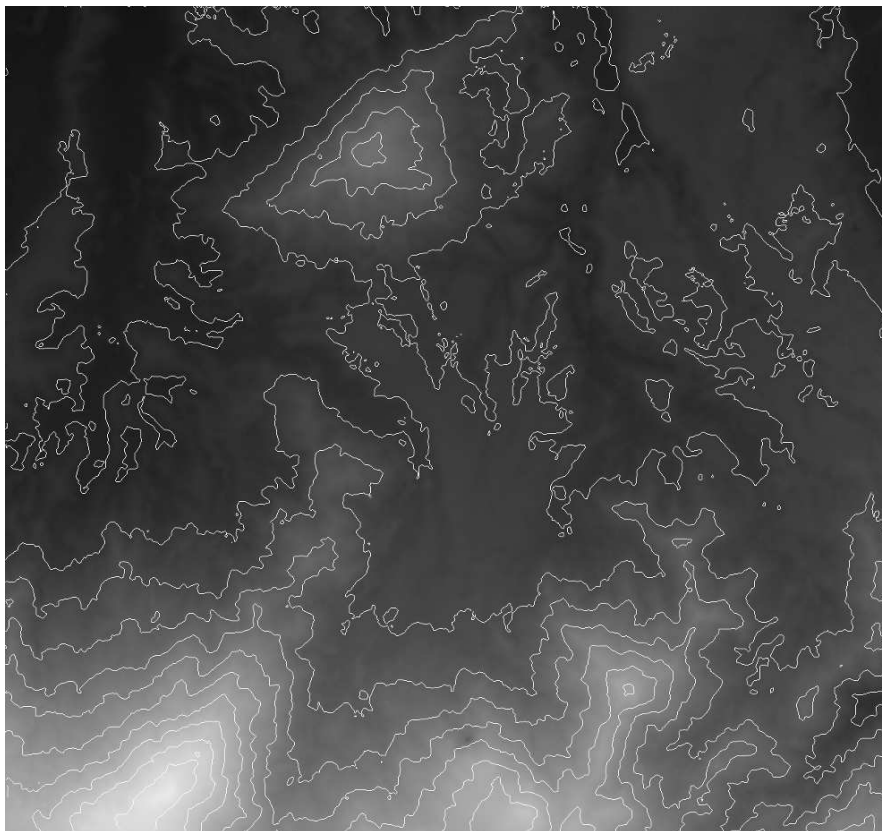

Fig. 39: DTM mosaic, 25 m contours overlaid

5.3.3

Creation of an ortho image mosaic

Similar to the chapter before, we will create an ortho image mosaic automatically. This has not only the advantage of faster work but gives us also the possibility to adjust the grey values of the input images to get a final ortho image with (nearly) no visible grey value edges (see this effect also in chapter 4.7.3).

Go to Processing > Ortho image, choose the option All images and let the Grey value adjustment be activated. File names: Terrain model GITT.IMA from our last chapter, output image ORTHO.IMA. Again, an info window informs you about

the progress of work. After the programme has finished, display the result for control (figure 40).

Remark: The ortho image mosaic as well as the DTM mosaic from before is of course geocoded. To use such images for commercial GIS software you have to convert them into a standard format like JPEG. Use LISA BASIC, options File > Export raster image, select the format and the file name, and then in the next window activate the option Additional file for ArcView (worldfile). This file contains the geometric parameters which can be used in the GIS software.

Created file: ORTHO.IMA

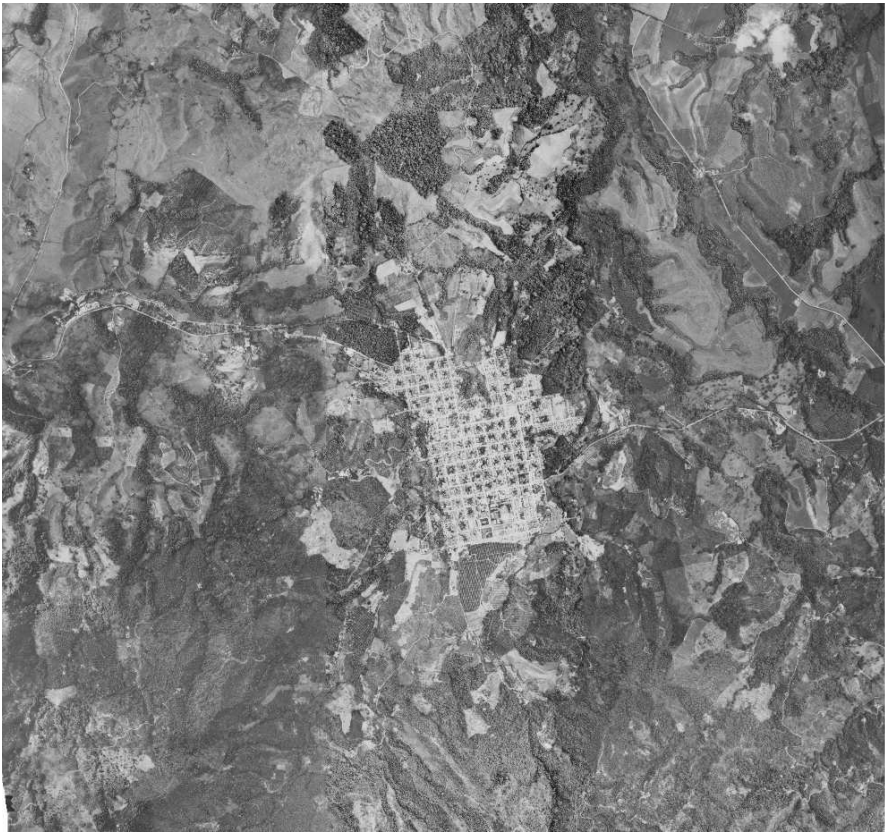

Fig. 40: Ortho image mosaic

5.3.4 Shaded relief

Let's play a bit with the various possibilities of DTMs and image combination: As an idea, we want to calculate a shaded relief image and combine this with our ortho image mosaic to produce a bit more spatial impression.

Exit the LISA FOTO programme and start LISA BASIC which we will use for the rest of this tutorial. Then, carry out the following steps:

- Terrain models > Graphics evaluation > Base image > Shading. Maintain all parameters, set the output file name to SHADE.IMA, then click onto OK. Remark: The default values Light from 315 deg., Inclination 45 deg. refer to the shading principle in cartography, "light from top left".
- Image processing > Matching > Addition. Then Weighted, set the Weight for image 1 to 70%, Image 1 ORTHO.IMA, Image 2 SHADE.IMA, Output image ADDI.IMA, then OK.

The result shows a combined image in the way that each grey value is calculated by 70% from the ortho image and 30% from the shaded relief image.

Created files: SHADE.IMA, ADDI.IMA

5.3.5 Contour lines overlay

Similar to chapter 4.7.4, you may calculate contours from the DTM mosaic, useful for an overlay over the ortho image mosaic. As we already discussed in that chapter, it is a good idea to filter the DTM before, giving smoother contours as a result:

Use Terrain models > Filtering, select the filter type Mean and a 7 by 7 window, set the input file to GITT.IMA, the output file to GITT_FLT.IMA, option Additional 8-bit image may be de-activated. Then OK.

Now go to Terrain models > Graphics evaluation > Base image > Contours vector. Set the parameters Equidistance to 25 m and Tolerance to 0.5 m, define CONTOUR.DAT as the name of the output file, then click onto OK. The result can be used for instance in one of the following ways:

- Display the image ADDI.IMA, then go to Overlay > Vector and load the file CONTOUR.DAT. This is only a temporarily overlay on the screen. May be you would like to create a fixed overlay, then
- Go to Vector data > Vector → raster. In the appearing window, choose Like given raster image, input file CONTOUR.DAT, raster image ADDI.IMA, then

OK. In the next window, choose Vector overlay, grey value 1 (black) or 255 (white) as you like, output image ADDI_2.IMA, then again OK. Display the result: The overlaid contours are included within the raster image.

Created files: GITT_FLT.IMA, CONTOUR.DAT, ADDI_2.IMA

5.3.6 3D view

As a final graphics result we would like to calculate a 3D view of our complete area. Remember that we have *height information* (our DTM mosaic) and *surface information* (for instance our ortho image mosaic combined with 30% shading). From these two “layers” it must be possible to calculate a 3D view from any viewing direction. This is the way:

Go to Terrain models > Graphics evaluation > Block image > Raster image 3D. In the appearing input image set the following parameters: Exaggeration 1.5 times, Raster image ADDI.IMA, Direction 40 degrees (=azimuth), Inclination 25 degrees, output image BLOC.IMA, then OK. The programme informs you about the size of the output image, and if it is ready, display the result on screen (see figure 41).

Remark: To see the many possibilities of the LISA BASIC module, it is a good idea to print out the programme description (stored in c:\lisa\text\lisa.pdf). See also LINDER 1999.

Created file: BLOC.IMA

5.3.7 3D view in real-time: Example for plug-ins

In our last example we calculated a “static” 3D view – direction and inclination were fixed. It would be nice to set these values in real time, turning the image in any direction you like. For this purpose now we use a so-called *plug-in*, a useful separate programme written by Dr. Michael Braitmeier, University of Düsseldorf. If you would like to create your own software and integrate it into LISA in a similar way, use the programme description of LISA BASIC (chapter Appendix, Plug-Ins) to see what to do.

Just go to Plug-Ins > IMA3D. The last used DTM (here: GITT.IMA) is loaded automatically and a first representation shows you a simple grid. Start Properties > Surface and choose ORTHO.IMA or SHADE.IMA, as you like. Set the parameters Horizontal tiles and Vertical tiles each to 3, then OK. Now go to Properties > General and set the parameter Exaggeration to 2, again OK.

Using functions from the Open-GL™ library, a (nearly) real-time zooming, panning and turning of the 3D view could be realised. Of course, the time to carry out these functions depends on the power of your computer!

For more information see the programme description of IMA3D, stored in c:\lisa\text\ima3d.txt.

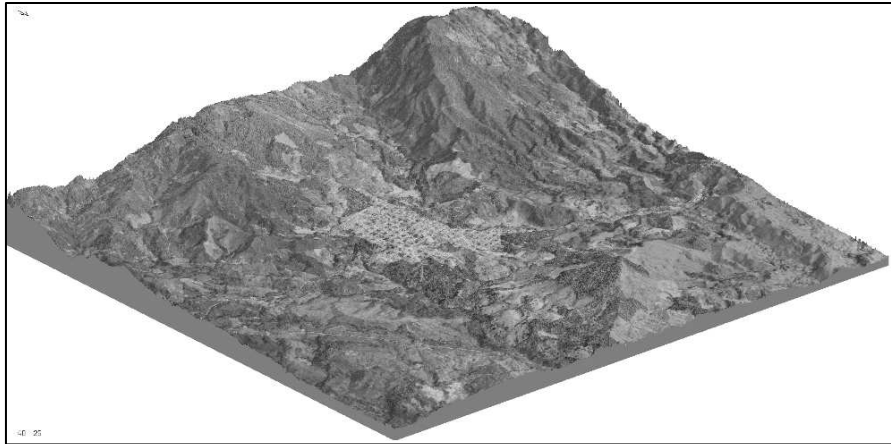

Fig. 41: Ortho image mosaic draped over the DTM mosaic (see also the book cover)

6 Example 3: Some special cases

In this 3rd tutorial, we want to learn some aspects about the handling of special or untypical cases and examples of close-range photogrammetry. What we did until now was to manage data which is typical for (digital) aerial photogrammetry and which of course can be processed with professional software packages – may be, even more comfortably and accurately with them.

But, the goal of this book and the included software is to give photogrammetric capabilities into the hands of people who are not specialists and who didn't have the money to purchase expensive hardware and software. Therefore, several options are included to process aerial photos using a simple A4 flatbed scanner, to handle images without any information about the camera parameters or even photos taken by a digital amateur camera.

6.1 Scanning aerial photos with an A4 scanner

Remember the fact that, if we want to use (aerial) photos from a metric camera, it is necessary to scan them in total, in particular including the fiducial marks (see chapter 3.1). And further, remember that the format of standard aerial photos is 23 by 23 cm (9 by 9 inch), too large for an A4 scanner. Therefore and due to the fact that simple flatbed (DTP) scanners have a geometric accuracy of normally not more than 50 μm , for professional digital photogrammetry we need a special and expensive photogrammetric scanner. Nevertheless, if you only possess a simple A4 scanner, don't hesitate to use photogrammetry!

What to do? Scan your photos in the following way (see figure 42): Put the photo onto the glass plate of the scanner to place the "flight direction parallel to the CCD array" as described in chapter 3.4. Now scan the maximum possible part of the photo with the left border included. Then move the photo to the left and scan the maximum possible part with the right border included. Both parts will have an overlap of about 80%.

Store the left part in a suitable image format (BMP, JPG or TIF) with a name of the form <image number>_L.xxx, for instance 137_L.BMP, and the right part analogue to that, for instance 137_R.BMP. Start LISA FOTO and go to File > Combination to put both parts together. You can either select the image parts if you

want to create one single matched image, or use the option `all nnn_L / nnn_R` to match all corresponding image parts in batch mode. In the latter case, the name of the output image is given automatically. Select the file format, then click onto OK. For further details, see the programme description (chapter 7.6.6).

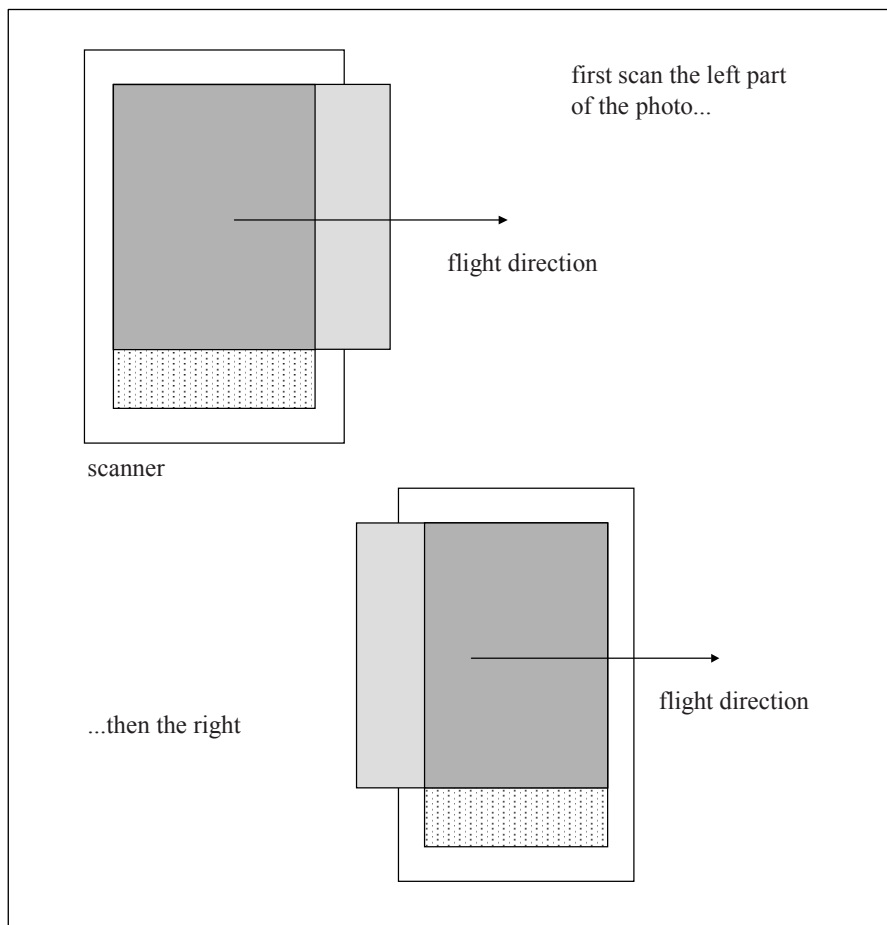

Fig. 42: Scan of an aerial photo on an A4 DTP scanner

The programme carries out an image matching algorithm using image pyramids and a maximum of 400 points, well-distributed in the overlap area. Of course – if an A3 scanner is available, you should use it.

6.2

Interior orientation without camera parameters

In chapter 4.2.1 we discussed the camera definition. For photogrammetric evaluation, the calibrated focal length and the nominal co-ordinate values of the fiducial marks are necessary, usually taken from the camera calibration certificate.

But sometimes, the latter one is not available. Usually, the focal length is given somewhere in the side information bar – if not, you may use 153 mm as the most common standard value (wide angle), or, if this doesn't fit, 305 mm (normal angle). How can we get the fiducial marks' co-ordinates?

One option is to use standard values. A directory (c:\lisa\cameras) was prepared during the installation which includes some camera definition files. Of course, they are not exactly those of the images you use, and to improve the values, a special option is offered here:

Start LISA FOTO with our first project, TUTOR_1, and go to Pre programmes > Orientation measurement. Load an aerial image, for instance 157.IMA, and choose the option Measure > Pseudo camera definition. Now, what's about the parameters?

Scan resolution: The programme calculates a default value which you might have to adjust. In our example, 300 dpi is the correct value.

Focal length: We use the value given in the side information bar, 152.91 mm.

Subpixel improvement: The same like in the interior orientation (see chapter 4.2.2; please activate this option).

Symmetry: You can use fiducial marks situated in the middle of the image borders and/or in the image corners. The axes defined by the fiducials are considered to be rectangle to another. At least two opposite fiducials must then be symmetric to the axes. In our case, the fiducials are situated in the middle of the borders (see also figure 13, bottom left), and each opposite two of them are symmetric – therefore, simply take the default values.

Output file: Use the default one, CAMERA_2.CMR.

After OK, move the image until the first fiducial mark lies exactly under the measuring mark. As already known, you may use the marked rectangle in the overview image for fast movement and the middle mouse button depressed for fine movement. For training, let's fix the following order of the marks:

No. 1 = right, No. 2 = bottom, No. 3 = left, No. 4 = top

Therefore, go first to the fiducial mark located in the middle of the right image border, and click onto the left mouse button if the correct position was reached, then to the second mark on the bottom, and so on until the last one is measured. Now click onto the Ready button and leave the window. The content of our file CAMERA_2.CMR will be like the following:

```
1  113.063    0.030
2   -0.012  -112.661
3 -113.039    0.030
4   -0.012   112.600
152.910
```

This file now can be used for the interior orientation. Of course, the results are calculated from only one single image and will surely differ a bit from image to image. Therefore, if you want to improve the data, you can do the same like described here for a second image, let's say No. 135, setting the output file to CAMERA_3.CMR:

```
1  113.145   -0.021
2   -0.051  -112.525
3 -113.042   -0.021
4   -0.051   112.568
152.910
```

Then calculate the mean for each value (No. 1 x, No. 1 y, No. 2 x, ...) and use this by editing the file CAMERA_2.CMR:

```
1  113.104    0.026
2   -0.032  -112.593
3 -113.040    0.026
4   -0.032   112.584
152.910
```

Please take into account that “real” values from a calibration certificate are more exact and should be used whenever possible!

6.3

Images from a digital camera

6.3.1 The situation

To get detailed information about soil erosion, an artificial test field was constructed and the surface photographed before and after several “rainfall” events. Figure 43 shows the test field with control points at the borders and the camera

position. If this method of modelling is of interest for you, see for instance WEGMANN et al. (2001), RIEKE-ZAPP et al. (2001) and SANTEL (2001).

The tests were carried out in collaboration between the Institute of Photogrammetry and GeoInformation (IPI), University of Hannover, and the National Soil Erosion Research Laboratory (USDA-ARS-NSERL), West Lafayette, Indiana, USA. Thanks to both organisations for the data!

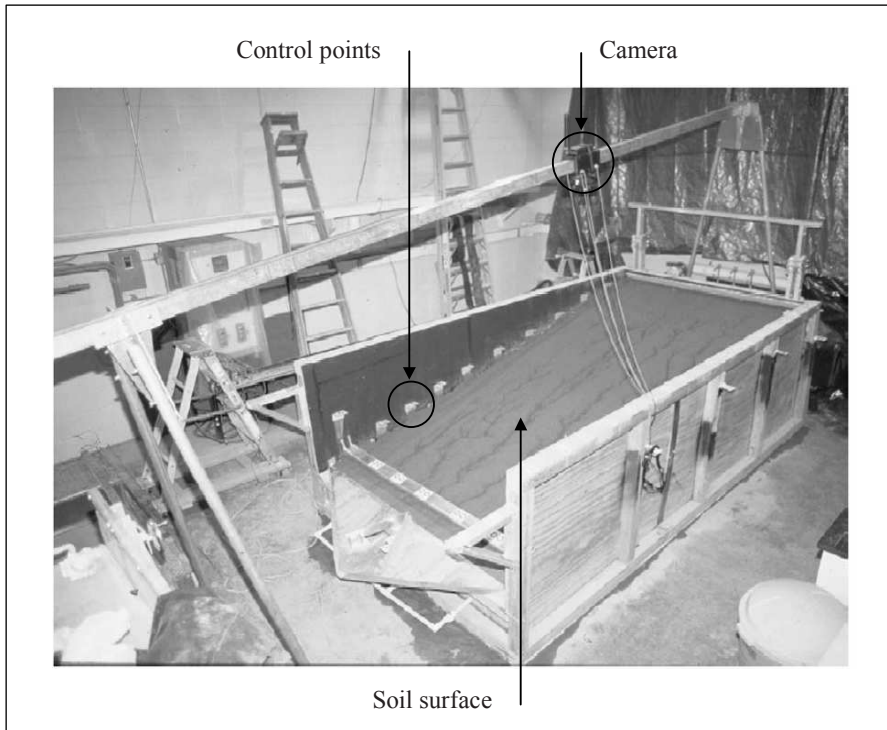

Fig. 43: Test field for soil erosion, a camera position, control points. From SANTEL 2001.

The images were taken with a digital monochrome camera, type Kodak DCS 1m with a Leica Elmarit R 2,8 / 19 mm lens. Some words about the object co-ordinate system: Of course it makes no sense to use a system like Gauss-Krueger or UTM – therefore, in cases like this we will use a Cartesian local system, sometimes called “non-world” in commercial software packages. But – what is non-world? Lunar? So, let’s better say *local*.

From the complete data set we will use one stereo model showing the initial situation before rainfall and another stereo model of the same region after 4 rainfall events, showing erosion on the whole area as well as a linear runoff (drainage)

system. From both cases, we will create a DTM, then calculate a differential DTM afterwards to evaluate the amount of eroded soil.

6.3.2 Interior and exterior orientation

Fiducial marks are only used to establish the interior orientation for photos taken from a traditional metric film camera. Digital cameras applied with an area CCD sensor do not need them because each CCD element gives the same image pixel every time.

Therefore, the method of camera definition differs a bit from that you already know, and the interior orientation is given directly and must not be carried out image per image. Start LISA FOTO with the project TUTOR_3_1.PRJ, then go to Pre programmes > Camera definition > Digital, and key in the following parameters: No. of columns 2036, rows 3060, principal point in x and y each 0 mm, focal length 18.842 mm, pixel size in columns and rows each 9 μm . These data you can get usually from the camera's manual. As name for the output file choose CAMERA_1.CMR.

After a click onto OK, in fact *two* files are created: CAMERA_1.CMR, the camera definition, and CAMERA_1.INN containing the interior orientation data for all images.

The next step will be the exterior orientation, similar to our first tutorial (chapter 4.2.5). The control points near the upper and lower photo borders are signalled and labelled, their co-ordinates stored in the file CONTROL.DAT. If you like you can make the orientation work for both images of both situations (No. 1005 left, 1004 right before rain, 5005 left, 5004 right after rain) now, use chapter 4.2.5 for advices. If not, simply load the files 1004.ABS, 1005.ABS, 5004.ABS and 5005.ABS from the CD-ROM (...data\tutorial_3\output).

The control points and their co-ordinates (all values in [mm]):

Point No.	X	Y	Z
2003	3806.904	2828.597	1095.195
2004	3369.888	2829.467	1273.887
2005	3021.855	2825.091	1274.496
2006	2549.527	2819.946	1380.263
2008	1875.663	2803.879	1530.468
2023	3882.687	878.742	1142.570
2024	3546.677	871.331	1202.315
2025	3144.343	865.521	1266.954
2026	2693.791	856.243	1328.317
2027	2253.322	852.145	1410.972
2028	1822.189	844.232	1526.819

Created files: CAMERA_1.CMR, CAMERA_1.INN, 1004.ABS, 1005.ABS, 5004.ABS, 5005.ABS

6.3.3 Geometric problems

As usual, our next step is to define the model. Go to Pre programmes > Define model and set the following parameters: Left image 1005, right image 1004, deactivate Cut border, use exterior orientations from ABS files, as object co-ordinates file take CONTROL.DAT. Maintain all other values (defaults) and go on with OK.

Two messages will appear, the first one telling you that a parallax correction is not possible, the second one inform you that 6 points are outside of the model area. The latter is clear: Some control points appear only in the left image, some others only in the right one. But what's about the first message?

Five control points (2004, 2005, 2006, 2025, 2026) were measured in both images, but the points 2004 and 2006 are located very near to one of the image borders so that only the remaining three points can be used. From a practical point of view at least four well distributed points must exist to set up the parallax correction. In our case it is not good to work without a correction as we will see:

Start Processing > Stereo measurement, start height is 1200 [mm]. Now try to set homologous points by adjustment of the z value (right mouse button depressed or, if existing, with the central mouse wheel) in several positions, near the model edges, in the model centre etc. You will find that in some positions the y parallaxes will reach five or more pixels, and this will give a negative influence for example if we want to generate a DTM by image matching.

We must deal with a second problem: It is a good idea to delimit the area of DTM creation to the soil covered part, but then the control points are outside of it. And last but not least, as you remember, for the matching process we need start points inside of our area.

Now, what are the reasons for our problems and what can we do?

Simple digital cameras are equipped with area CCD arrays of low geometric accuracy. Furthermore, for shock absorption these arrays are not really fixed with respect to the camera body but are built into a soft frame. And above all, as we will see in detail later (chapter 6.5), the lens usually has geometric distortions. Especially these distortions normally should be corrected by carrying out a camera calibration before taking the images.

If we have not the possibility to do that, the only remaining way is a parallax correction via a non-linear polynomial approach, but for this we need a great amount of well-distributed homologous points – also serving afterwards as start

points for the matching process. To get them we can use the Stereo measurement and within that the option Digitise > Grid to get regularly distributed points, but often it is a better way to measure suitable points without a pre-positioning. Before we will do so let's talk about what "suitable" means in this context.

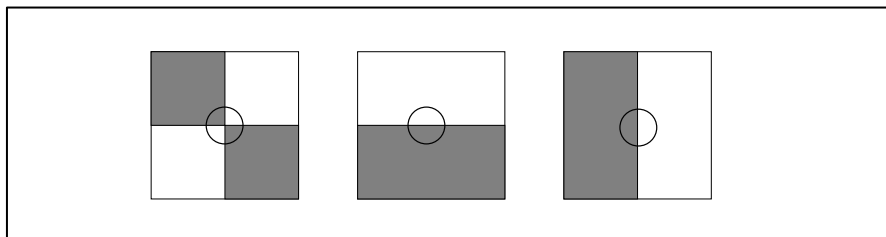

Fig. 44: Schematic drafts of points with good contrast. Left: Suitable for all purposes. Middle: Suitable only for y parallax correction. Right: Suitable only for measurement of the x parallax (\rightarrow height or z value).

Keep in mind that with the help of these points the programme shall try to find and correct y parallaxes. Therefore we need points with good contrast especially in y direction. On the other hand we want to use these points also as start points for the stereo correlation where we need good contrast in x direction to calculate precise heights. Therefore try to find points with a good contrast in all directions. A file with such points is already prepared for you (START_1000.DAT). For instance, you can use the Processing > Stereo measurement option and then Overlay > Vector data, then select this file to see what we mean. But of course you may measure points for yourself using the Digitise > Points / lines option (see chapter 4.6.3 for instance).

As a result, we have a file with a sufficient number of points to improve the model definition. First we reduce the project area to the soil covered part like mentioned before: Go to File > Select project and select TUTOR_3_1.PRJ. Again, start Pre programmes > Define model. Contrary to the first start of this option, set the parameter Maximum y parallax to 8 pixels, the Correction of y parallaxes to polynomial, and activate the option Test image. In the Exterior orientation section of the input window set the file Object co-ordinates to START_1000.DAT, then click onto OK again.

Now, within the y-parallaxes section of the result window we see that these parallaxes could be reduced to 0.14 pixels using 51 certain points for the polynomial approach (the values depending on the file with start points you have used). The values of Mean window size and Mean correlation coefficient may be used in the stereo correlation (next chapter). If you now will start the Processing > Stereo measurement option again and try to set homologous points, you will see that the remaining y parallaxes are significantly smaller than before. With this result not only stereo viewing is easier but also the DTM generation via image matching (stereo correlation) will work properly.

In the same way we have to prepare the model “after rainfall”, the images 5005 (left) and 5004 (right). The point file START_5000.DAT is also prepared for you, but again and for training you may measure own points. After that carry out the model definition with the same parameters like used before. The parallaxes here are reduced to 0.07 pixels using 61 certain points (again depending on the file with start points you used).

Created files: START_1000.DAT, START_5000.DAT, 10051004.MOD, 50055004.MOD

6.3.4 DTM creation

First go to Pre programmes > Select model and choose 10051004. Then start Processing > Stereo correlation and set the following parameters: Z range ± 15 [mm], Correlation coefficient > 0.8, Correlation window 13 by 13 pxl, number of iterations 10. Set the name of the output image (DTM) to GITT_1000.IMA, activate Filtering, maintain all other parameters as set by default, then click onto OK. If necessary, see chapter 4.6.2 for further information.

Now go to Pre programmes > Select model and choose 50055004. Start Processing > Stereo correlation. Set the following parameters: Z range ± 20 [mm], Correlation coefficient > 0.8, Correlation window 7 by 7 pxl, number of iterations 10. As name of the output image (DTM) use GITT_5000.IMA, then click onto OK.

Some remarks concerning the parameters we have used: As you can see, the images 1004 and 1005 have low contrast in some areas. Therefore we selected relatively large windows (13 by 13 pixels) to get a better statistical base, and a high number of iterations (10). With this we can improve the result – in particular, we get a high number of correlated points, remaining only few positions filled by interpolation. In the second model (after rainfall) the contrast is better due to the relief. Therefore the windows can be smaller, and besides there is a the rule “the more relief, the smaller the correlation windows” (see also chapter 4.6.1).

May be you find the z range very high, especially in comparison to our former examples were this value was usually like the ground resolution (pixel size defined in the project definition). Within the Stereo measurement option you can control the movement of the images depending on height changes.

Created files: GITT_1000.IMA, GITT_1000_8BIT.IMA, GITT_5000.IMA, GITT_5000_8BIT.IMA

With the just created DTMs of both situations we are able to calculate a differential DTM, showing us the effect of erosion and giving us the possibility to calculate the amount of soil washed out during four rainfall events.

6.3.5 Differential DTM

Please close LISA FOTO and start LISA BASIC, use TUTOR_3_2.PRJ like before. Go to Terrain models > Matching > Differential DTM and set the first file name to GITT_1000.IMA, the second to GITT_5000.IMA, keep the name of the output image to DIFF.IMA and maintain all other parameters, then click onto OK. The next window informs you about the minimum and the maximum value of height difference. Just click onto OK again and display the result DIFF_8BIT.IMA, if you like. This is the 8-bit representation of the differential DTM.

Both DTMs as well as the differential DTM are shown in figure 45. For a better representation of the terrain surface, 10 mm contours were created and overlaid (see chapter 4.7.4 how to do this).

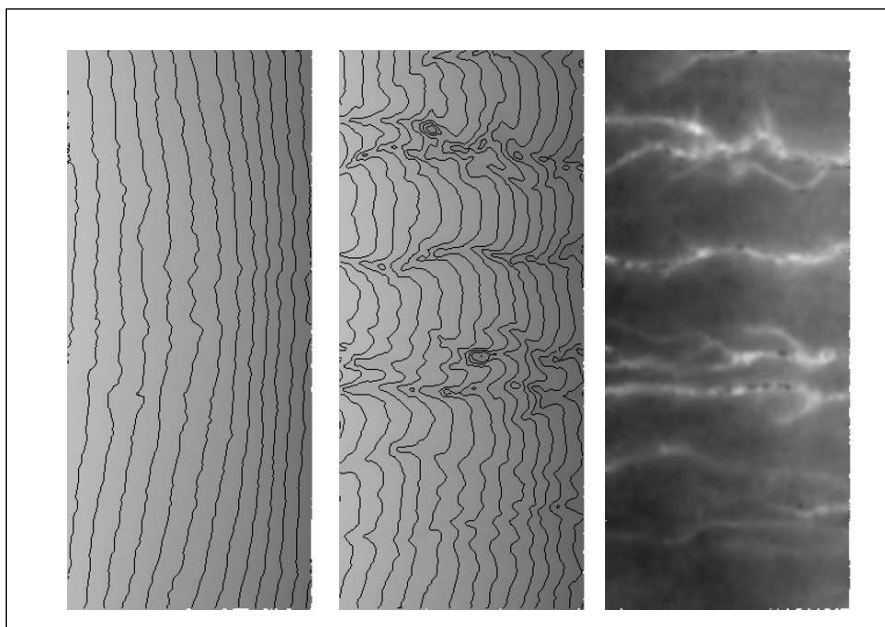

Fig. 45: Situation before rain (left) and afterwards (middle), 10 m contours overlaid, differential DTM (right)

Now, as a last step in this example, let's calculate the amount of soil washed out: Use Terrain models > Load / change DTM to control whether the differential DTM (DIFF.IMA) is our actual one. Then start Terrain models > Numerical evaluation > Volume differences, the name of the output file keep as STAT.TXT. The result will look more or less like following:

Volume differences:

Decrease	21992615.0285	mm ³
Increase	0.0000	mm ³
Saldo	-21992615.0285	mm ³
in average	19.5560	mm height change.

Resolution:	3.0000	mm in xy,
resp.	0.0038	mm in z.

The results are given in [mm³] and [mm] according to the length unit selected in the project definition. Within our model area about 21.99 dm³ of soil was eroded with an average height change of 19.6 mm between the terrain models.

Finally, let's talk about some problems we can find in the relief "after rain": As you may have seen, the valleys have very steep slopes in some regions, caused by heavy erosion of the soil which is not protected by vegetation. This effect is known in reality as "gully erosion". As a consequence, we have hidden areas in some parts (see also figure 26). This in conjunction with the dark, nearly contrast-free bottom of the valleys may lead to problems in the matching process and the derived DTM, for example unrealistic holes and peaks within the valleys. Such incorrect DTM heights have of course an influence on the differential DTM as well as on the volume differences calculated from it.

Created files: DIFF.IMA, DIFF_8BIT.IMA, STAT.TXT

6.4 An example of close-range photogrammetry

6.4.1 The situation

The last example already belongs to so-called *close-range photogrammetry* but in fact, it has a geometric situation similar to the aerial case (vertical images). The next example shows a more typical close-range or terrestrial case.

For coastal protection, it is necessary to know as much as possible about wave movement and wave energy. Therefore, stereo images of waves rolling onto the shore were taken from two buildings situated in Norderney, an East-Friesian island in northern Germany, using four digital cameras, type Ikegami SKC-131 with a Cosmimar / Pentax 12.5 mm lens (wide angle). Figure 46 gives you an impression about the area and the camera positions. For our example we will use images from cameras I and II.

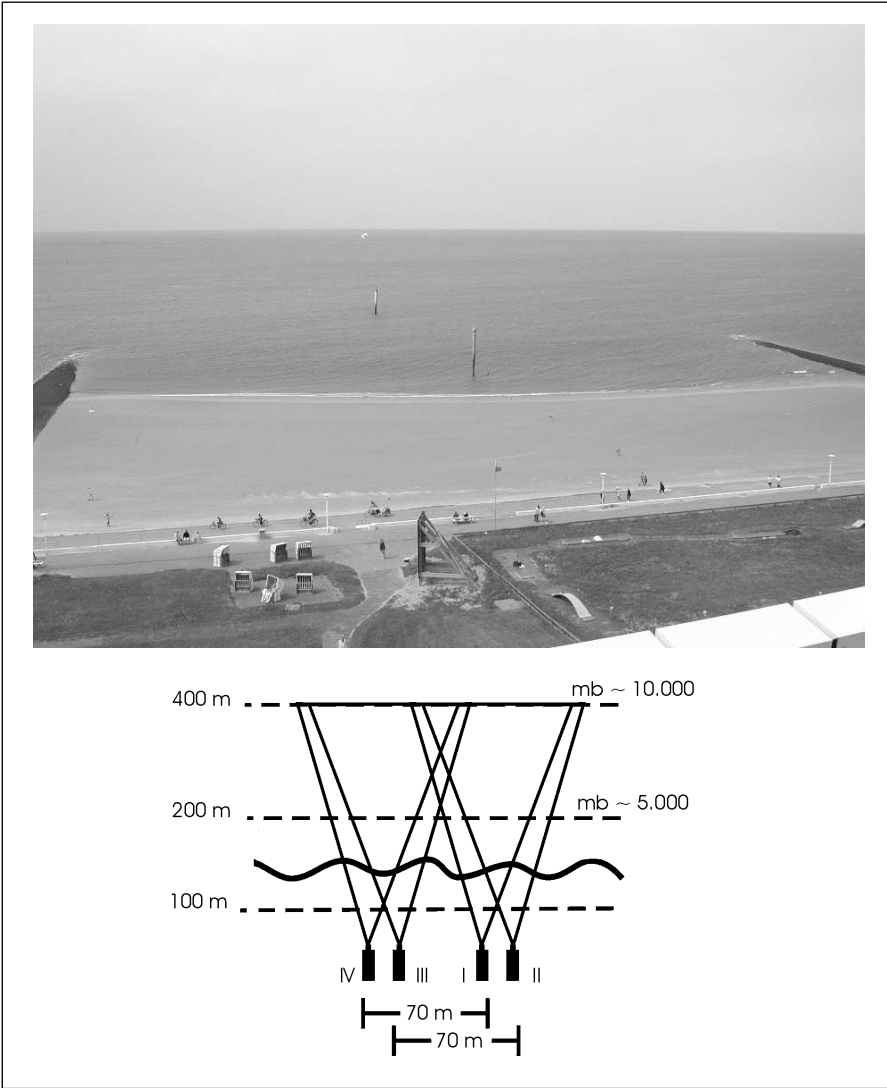

Fig. 46: The test area (above) and the camera positions on top of two houses (below). From SANTEL et al., 2002)

The interdisciplinary project “WaveScan” was carried out by the Institute of Fluid Mechanics (ISEB) and the Institute of Photogrammetry and GeoInformation (IPI), both University of Hannover, and sponsored by the Federal Ministry of Education and Research (BMBF), code 03KIS026. All rights of the image data are owned by the IPI.

The cameras were activated simultaneously in time intervals of 1/8 seconds by a wireless equipment, developed by Dr.-Ing. D. Pape. This is necessary because the object (water surface) is moving. The differences between this and all previous examples concerning the geometric situation are:

- The images were not taken “camera looking down” giving us vertical images, therefore, we have oblique images with a large variation of the scale. As a result, the values of the rotation angles φ and ω are no more near zero.
- The cameras were situated on top of a building of only 45 m height, our field of interest has an extension of some 100 meters in front. This leads to several hidden areas, the backward sides of greater waves.
- The projection rays [projection centre \rightarrow image centre] are not parallel but slightly convergent.

As you will see, there are further problems: The images are not very sharp as a result from the misty weather and a resolution of only 1296 by 1031 pixels. And, the rolling waves produced linear parallel forms in the images which lead to the effect of repetitive structures, already discussed in chapter 4.6.1.

The goal is to calculate a “DTM” of the water surface. In principle, this is nothing new for us, and therefore we will only take a look at the differences in the work flow, and what it means in particular to the exterior orientation.

From the complete data set collected in the project, a sub sequence is prepared for this example with the images 100001 ... 100005 (left) and 200001 ... 200005 (right). The images were taken with camera I and II from the right building (see figure 46).

6.4.2 Interior and exterior orientation

Start LISA FOTO using the project TUTOR_4.PRJ, then go to Pre programmes > Camera definition > Digital. With the file open button you can see that two cameras are already prepared: CAMERA_1.CMR and CAMERA_2.CMR, both calibrated which means that we have values for the principal point and the radial-symmetric lens distortion for both cameras (see chapter 6.5). The image names (6 digits) serve to connect them to the respective camera: 100001 ... 100005 \rightarrow camera 1, 200001 ... 200005 \rightarrow camera 2 (see chapter 7.9.7).

Remember chapter 6.3.2: The interior orientations for all images taken with these cameras are also defined now.

The control points we will use for the exterior orientation are shown in the figures 47 and 48, their co-ordinates are listed below and prepared in the file CONTROL.DAT.

Point No.	X	Y	Z
100	2575400.404	5953951.649	9.008
101	2575400.130	5953951.787	4.435
104	2575400.128	5953951.799	2.634
105	2575431.675	5953971.315	7.275
106	2575431.682	5953971.309	4.443
109	2575431.683	5953971.298	2.630
110	2575406.817	5953976.222	11.862
111	2575310.374	5954111.996	8.712
144	2575489.288	5953866.850	7.414
145	2575490.007	5953867.365	7.417
146	2575514.772	5953884.686	7.433
147	2575518.685	5953887.285	7.423
153	2575490.736	5953867.634	10.188
154	2575512.349	5953882.868	10.197

Like in our example before, we must carry out the exterior orientation by measuring the control points manually. Go to Pre programmes > Orientation measurement, load image No. 100001, and choose Measure > Exterior orientation. Select CONTROL.DAT as the name of the control point file. Now, here comes the first difference with our examples before: Due to the fact that we have no vertical images, it may happen that the orientation process will have some difficulties to converge. In this case is advisable to select the first three or four points in the way that they cover a maximum part of the image. In our example these may be the point sequence 110, 144, 147 and then 154.

Alternatively you may enter the (approximate) co-ordinates of the projection centre in the input window. This will also help the programme to calculate the parameters of the exterior orientation:

Image No.	X	Y	Z
100001 ... 100005 (left):	2575527.7	5953793.9	45.3
200001 ... 200005 (right):	2575541.6	5953807.3	45.3

Now use figures 47 and 48 to find the correct GCP positions – this may cause some problems because the images are not very sharp, see above. But, try to do your best, it's a good training! See chapter 4.2.5 for more details if necessary.

After the last point is measured, take a look at the results below (residuals, standard deviation). If they are bad, you may mark the worst point in the list window and click onto the (De)activate button. The point is now marked with an S (=skipped) instead of the M (=measured). If you are satisfied, save the orientation data using the Ready button and close the window.

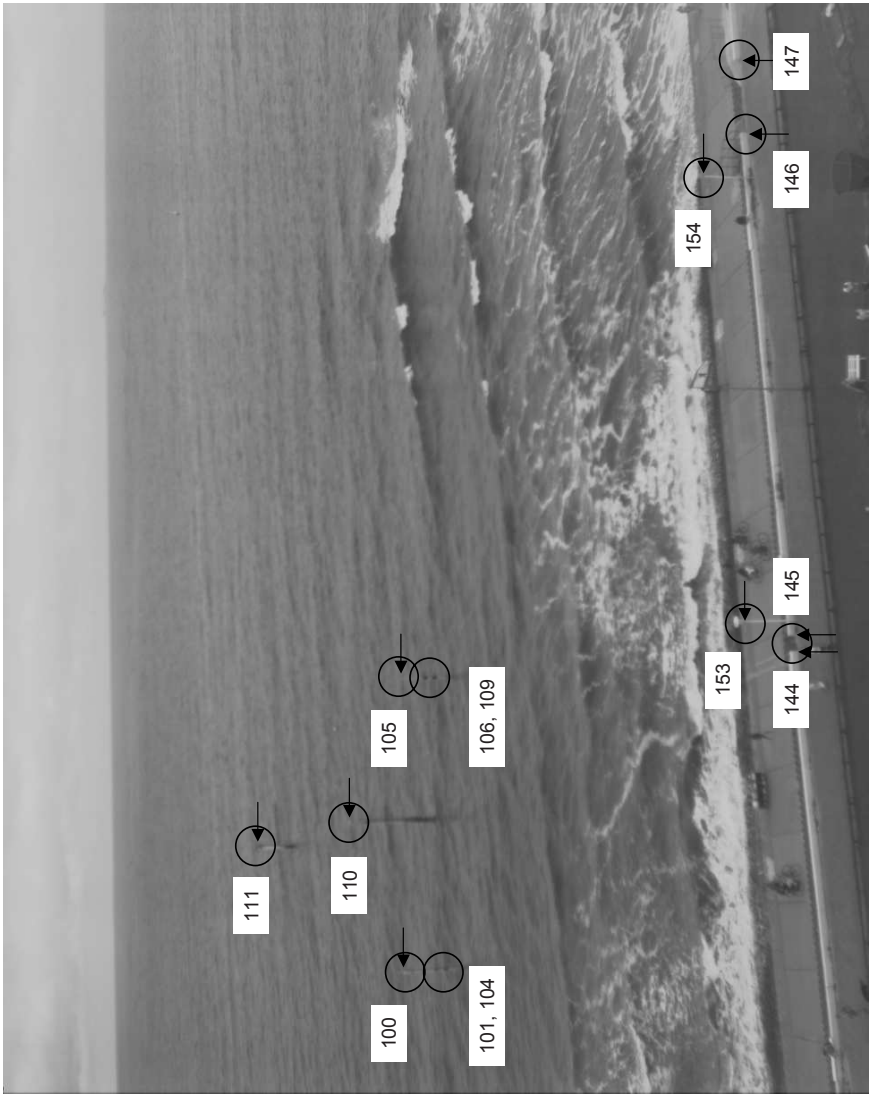

Fig. 47: Approximate positions of the control points

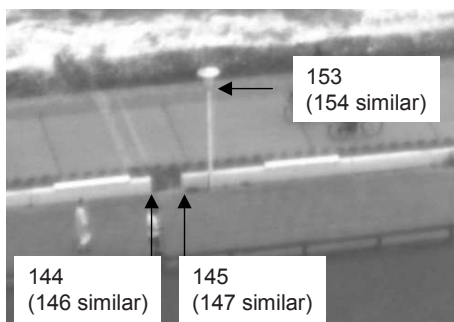
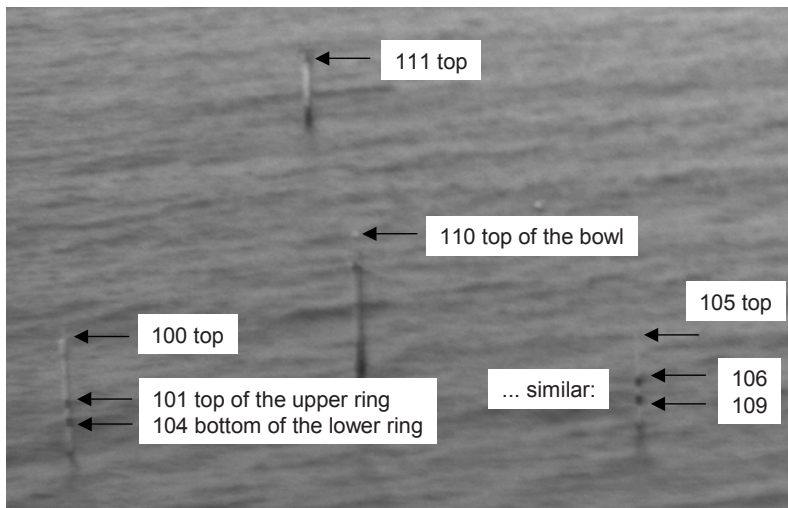

Fig. 48: Positions of the control points in detail

Remark: Concerning the results, always remember the pixel size. In case of scanned images this means the scan resolution, in case of images from a digital camera (like here) it means the resolution of the sensor. The camera used here has a sensor with pixels of about 6.7 μm length / width (see the camera definition). Even if we take into account the situation (oblique and not very sharp images) the standard deviation should not be more than 3 or 4 pixels.

In the same way like before carry out the exterior orientation for image No. 200001, the right one of our stereo model.

Now remember that with each camera a lot of images were taken in time intervals of 1/8 seconds. All images taken with the *same* camera from the *same* posi-

tion of course have identical exterior orientations, therefore it is not necessary to measure (calculate) the orientation parameters for the other images of our sequence. In chapter 6.4.5 you will see how to handle all of the following images automatically.

Created files: CAMERA_1.CMR, CAMERA_1.INN, CAMERA_2.CMR, CAMERA_2.INN, 100001.ABS, 200001.ABS.

6.4.3 Model definition

As already pointed out in chapter 6.3.3, we can help the programme to correct the y parallaxes by the measurement of several well-distributed points, either manually or automatically. For this example, a file with manually measured points (START_PNT.DAT) is prepared and may be used here:

Select Pre programmes > Define model and set the following parameters: Left image 100001, right image 200001, maximum y parallax 5 pxl, correlation coefficient > 0.7, correction of y parallaxes affine. Deactivate Cut border, activate Test image, choose Parameters from ABS files and set the name of the object co-ordinates file to START_PNT.DAT, then click onto OK.

If you like, take a look at the test image to control number and position of the points used for the correction of y parallaxes.

Created files: 100001200001.MOD, MOD_TEST.IMA.

6.4.4 DTM creation

First go to Pre programmes > Select model and choose 100001200001. Then start Processing > Stereo correlation. Before going on, let's remember the difficulties of the situation, low contrast and repetitive structures. To handle them we will use the manually measured points as start points, a low z range and a high correlation coefficient threshold value.

Set the following parameters: Z range 0.2 m. This seems to be small, but remember that the programme will move within the epipolar plane (see chapter 4.5 and figure 1) and we have oblique images! Set the Correlation coefficient to 0.8, the Correlation window to 7 by 7 pxl, number of iterations 3.

Object co-ordinates START_PNT.DAT. Additional vector data BORDER.DAT (already prepared for you; you may create a border polygon within the stereo measurement module using Digitise > Points / lines, there choosing the code Free cut area polygons, and after that setting some Delete start points. See chapter 7.9.2 and the appendix, part 1, for further details). Set the name of the output image (DTM) to GITT_TST.IMA. Please activate the option Filtering and de-activate the option Additional 8-bit image. If necessary, see chapter 4.6.2 for further information.

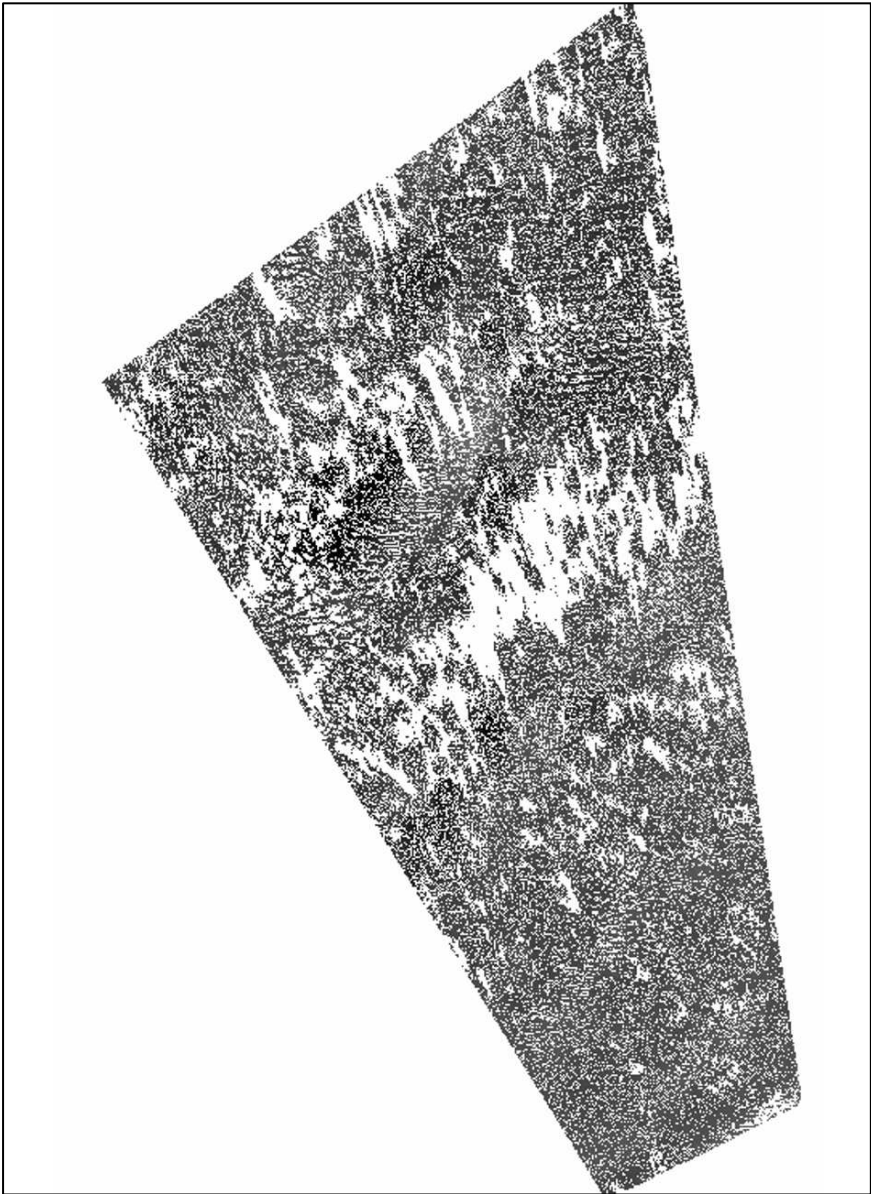

Fig. 49: Points found by correlation, showing the wave structures. The cameras are looking from bottom right.

After OK, the matching process already known from previous examples begins. When the DTM improvement is calculated, you can see the wave structure displayed on the screen, looking somewhat like figure 49.

Please recognise that the points found by correlation are concentrated in some areas, showing front and top of the waves. Large areas without points are located on the backward slopes of the waves, parts of them hidden in the images as a result of the relatively low height of the camera positions, other parts with very low contrast.

Created files: GITT_TST.IMA, GITT_TST_8BIT.IMA.

6.4.5 Image sequences

In this chapter we want to see how sequences of stereo pairs (time series) can be handled automatically. Remember that we have fixed camera positions – interior and exterior orientations as well as the model definitions (y parallax correction) can be seen to be constant.

The main idea is that, depending on the time interval Δt , changes in the surface model between t_i and $t_i + \Delta t$ are not too large. Therefore, if the time interval is small enough (depending on the speed of changes / movement), we can use the following strategy:

- Prepare the first model and calculate the first surface (DTM)
- Extract a set of well distributed points from this surface, serving as start points for the following model
- Calculate the next surface with these start points

As an option, the generated start points of all models can be stored. Also, an ortho image may be produced from every surface model.

In the following we will use five models from the whole data set: Images 100001 ... 100005 (left) and 200001 ... 200005 (right). Please select Processing > Image sequence and set the following parameters:

First model, left 100001, right 200001; Last model, left 100005, right 200005; Start points for 1st model START_PNT.DAT; Grid width (output) 1 m. Let the option store be deactivated but activate the option create ortho images, then OK.

The next window you know from the stereo correlation in the previous chapter – please take the same parameters like there. It is not necessary to define the name of the output image (the surface model) because all names are generated automatically. The DTMs will get names like GT_100001200001.IMA, the ortho images names like OR_100001200001.IMA and so on. Make sure that the option Interpolation is

activated, necessary for the creation of the ortho images. After a click on OK, the programme starts and will inform you in a window about the progress.

Created files: GT_100001200001.IMA ... GT_100005200005.IMA,
OR_100001200001.IMA ... OR_100005200005.IMA.

6.4.6 Visualisation of wave movement

Finally we want to see the changes during time. Let's follow the idea to calculate 3D-views of the ortho images and bring them together. To save time and space we will only use every 2nd model: 100001200001, 100003200003, 100005200005. Close the LISA FOTO programme and start LISA BASIC.

Terrain models > Load / change DTM and choose GT_100001200001.IMA. Start Terrain models > Graphics evaluation > Block image > Raster image 3D and set the following parameters: Exaggeration 2 times, View direction 210 deg., View inclination 25 deg., Input image OR_100001200001.IMA, Output image WAVE_1.IMA. Maintain all other parameters and go on with OK. If you like, you can control the result using the raster display.

Repeat all steps with GT_100003200003.IMA, OR_100003200003.IMA, Output WAVE_3.IMA and GT_100005200005.IMA, OR_100005200005.IMA, Output WAVE_5.IMA.

To match the images together, you can use the option Image processing > Image geometry > Mounting. Set the names Image 1 to WAVE_1.IMA, Image 2 to WAVE_3.IMA, Image 3 to WAVE_5.IMA and the output image to DIFF_3D.IMA, then OK. The next window offers you the possibility to set the relative positions of the images. Set No. 1 (= WAVE_1.IMA) in the upper left field, all fields right of it to zero, No. 2 (= WAVE_3.IMA) as first field in the second row and No. 3 (= WAVE_5.IMA) as first field in the third row which means that the images are mounted one below the other:

```
1 0 0 0 0
2 0 0 0 0
3 0 0 0 0
0 0 0 0 0
0 0 0 0 0
```

After OK, the combined image will be created (see figure 50), showing us the movement of the values in a time interval of 0.25 seconds.

Created files: WAVE_1.IMA, WAVE_3.IMA, WAVE_5.IMA, DIFF_3D.IMA.

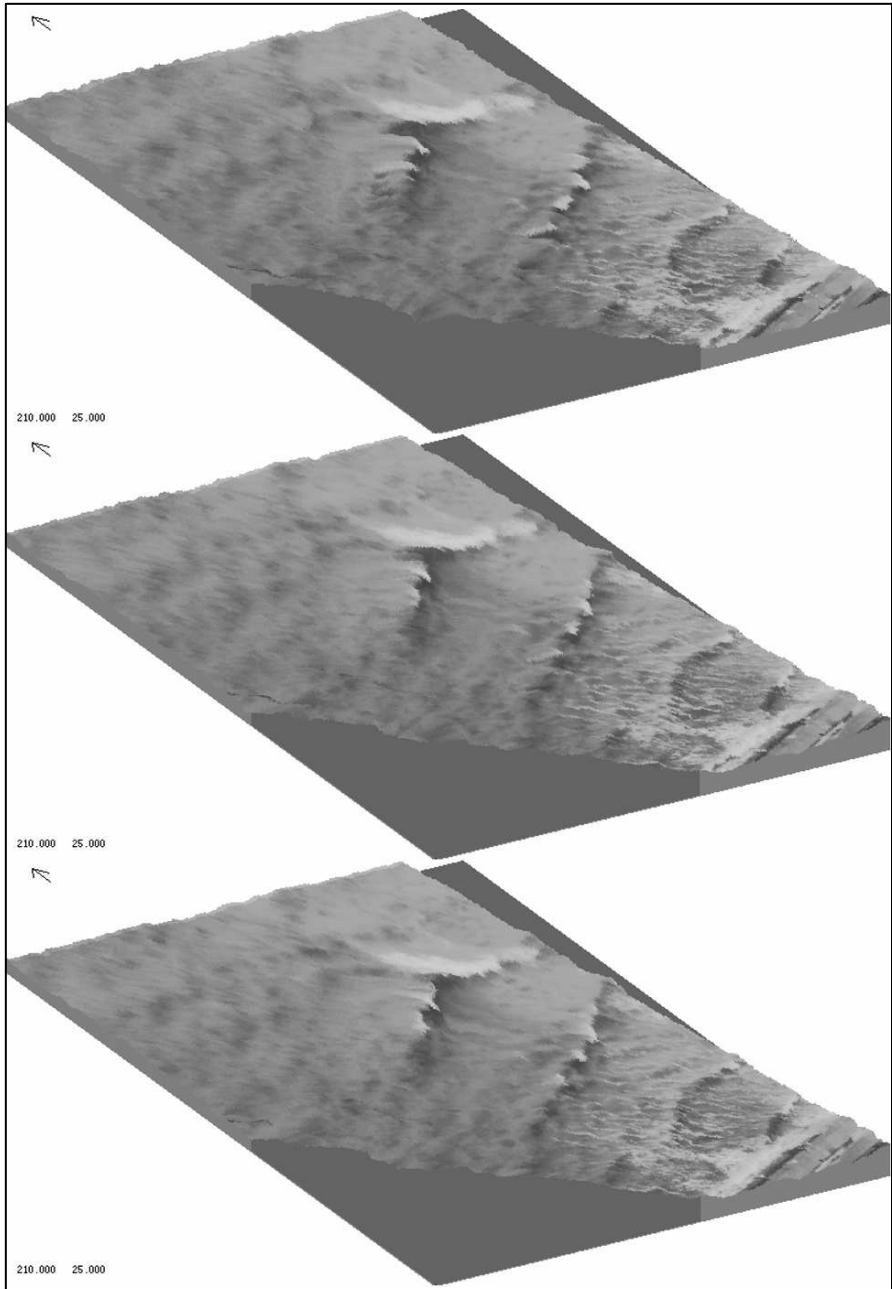

Fig. 50: Wave movement, time interval 0.25 seconds.

6.5 Some remarks about lens distortion

To explain the various effects of lens distortion let's start with the following figure showing a garage door. Both images were taken with a consumer camera, type Rollei dp 3210.

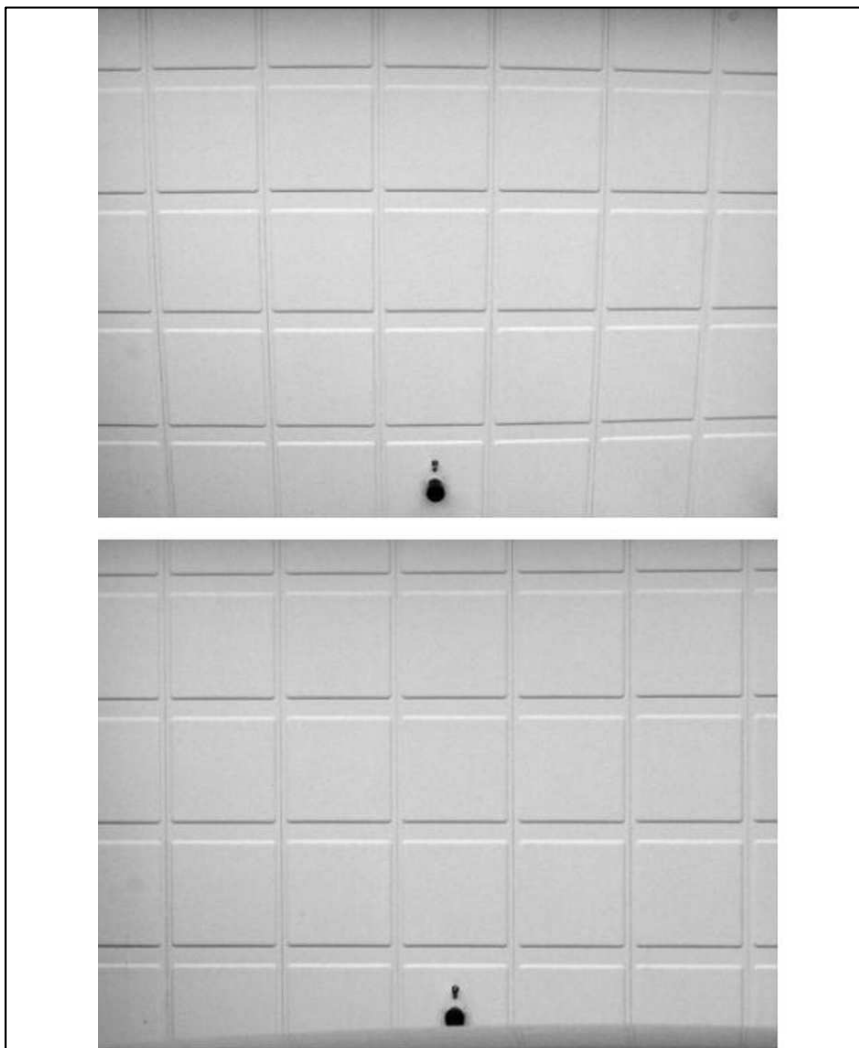

Fig. 51: Effects of lens distortion. Above: Focal length 5.7 mm (wide angle), barrel-shaped distortions. Below: Focal length 24.5 mm, very few distortions.

The camera is equipped with a zoom lens (like most consumer cameras), the focal length can be set between 5.7 (wide angle) and 57 mm (telephoto). A typical effect in wide angle mode are the barrel-shaped distortions, that means, straight lines near the image borders are shown bended to the borders. This effect usually will be less or zero in medium focal lengths and may turn into the opposite form (pincushion-shaped) at telephoto mode (see figure 52).

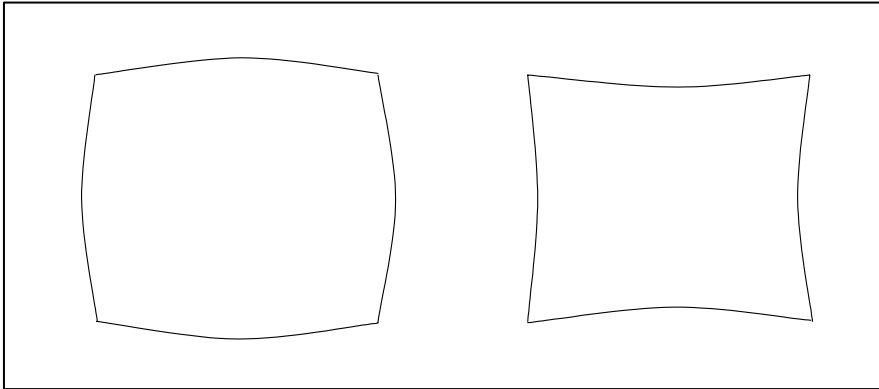

Fig. 52: Barrel-shaped (left) and pincushion-shaped (right) distortions.

Beside these so-called radial-symmetric distortions which have their maximum at the image borders there are more systematic effects (affine, shrinking) and also non-systematic displacements. The distortions depend among others on the focal length and the focus. To minimise the resulting geometric errors efforts have been undertaken to find suitable mathematical models (for instance see BROWN 1971).

In most cases the radial-symmetric part has the largest effect of all. The resulting errors are symmetric to the so-called *principal point*. This is the point in which a projection ray is normal (rectangular in all directions) to the film plane or the CCD sensor. In the camera definition module of LISA FOTO you can activate the option Distortion and then, if you know the parameters of one of the usual models, you can enter them there. See chapter 7.7.1 for more details.

Remember our example of image sequences (chapter 6.4) where we used calibration parameters for both cameras. If you like please go again to this example, select Pre programmes > Camera definition > Digital, then use the File open button and load CAMERA_1.CMR. Then click onto OK. In the next image you see the different models you can use. Internally all of them are re-calculated to a third-order polynomial like offered as option 3. Again click on OK and overwrite the file CAMERA_1.CMR. Now start the image display – an image called CALIB.IMA should be displayed (if not, just load this image):

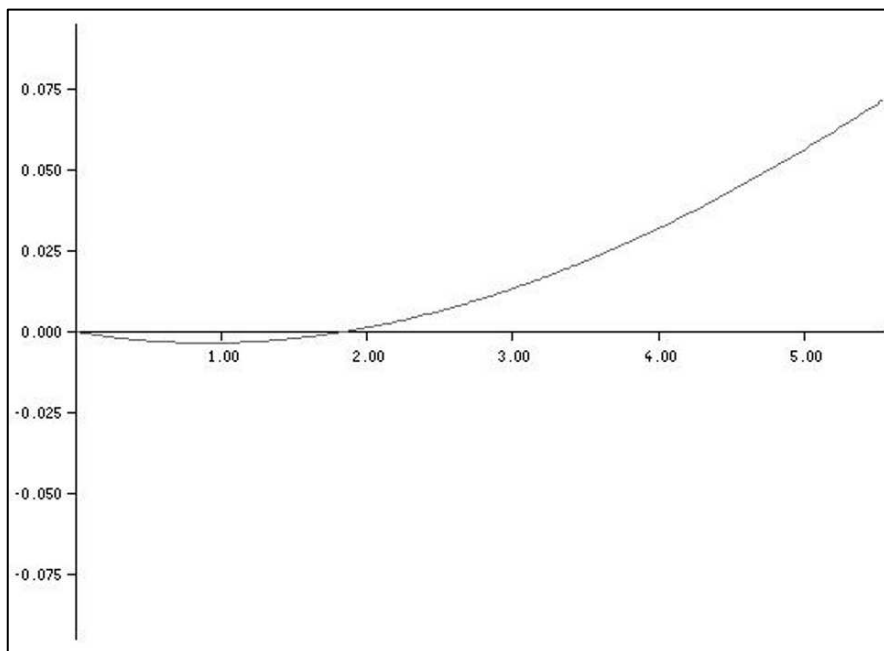

Fig. 53: Radial-symmetric lens distortions modelled by a third-order polynomial.

Depending on the distance to the principal point, correction values between zero and about $70\ \mu\text{m}$ (= about 10 pixels!) will be used to minimise the distortion effect. The cameras from the WaveScan project was equipped with wide-angle lenses (see chapter 6.4.1) and had the typical barrel-shaped distortions.

Remark: In the unlimited version of LISA FOTO you can calculate the distortion parameters for yourself. You need a calibration plate (LICAL) with 77 target marks. After taken an image from this, use the options Pre programmes > Orientation measurement and then Measure > LICAL (see chapter 7.7.8 and LINDER & HEINS, 2005).

Created file: CALIB.IMA

6.6 Stereo images from satellites

Since few years a new chapter of photogrammetry has opened: Stereo images taken from satellites. If you remember the examples from this book we have seen that photogrammetric methods in principle do not depend on the size of the object or the distance between camera positions and object: We can handle aerial images in more or less the same way than terrestrial images in close-range applications. It

is also possible to use images taken with the help of stereo-microscopes. Therefore we should be able to handle stereo pairs of images of any scale or ground resolution – why not satellite images?

We have to deal with one significant difference, the camera geometry. In all of our examples we used images from central-perspective cameras, as you remember: For each image we have one projection centre, the intersection point of all projection rays. The central perspective leads to radial-symmetric displacements according to the relief (for instance, see figure 26), and these are pre-requisite that we see the images stereoscopically and that we can measure three-dimensional object co-ordinates.

The digital cameras which are operated on satellites usually have a quite different geometry. In contrary to the central-perspective ones we know (CCD area sensor, “frame” camera) they only have a line sensor, “looking down to earth” and scanning the earth’s surface line by line. As a result we have central perspective only within a single line (across the flight direction) but a parallel projection from line to line (in flight direction).

Modern satellite cameras often have more than one line: For instance, one line is straight looking down, one is looking backward, another forward. In this way stereo images can be obtained: One image from the “looking forward” scan line, the other some minutes later from the “looking backward” scan line (figure 54).

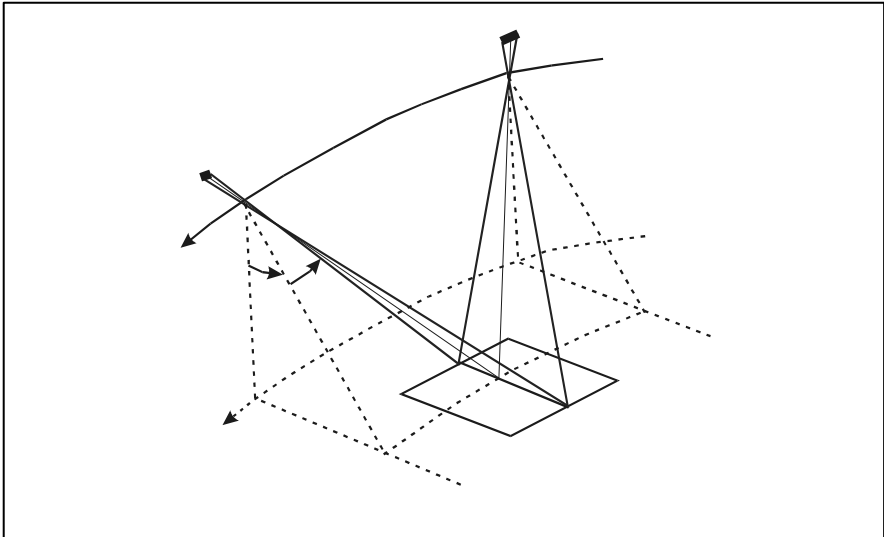

Fig. 54: Geometry of stereo images from satellites. From JACOBSEN, 2007.

Due to the geometry just described, we cannot use our standard approach from the examples before. Remember that we calculated image co-ordinates from object co-ordinates (x, y, z) using the collinearity equations (formula 4.3.1). In the cases handled here, these equations must be replaced by different ones, using the so-called rational polynomial coefficients (RPCs; see for instance GRODECKI 2001):

$$x' = \frac{P_1(x, y, z)}{P_2(x, y, z)} \quad y' = \frac{P_3(x, y, z)}{P_4(x, y, z)}$$

with $P_n(x, y, z) = a_1 + a_2*y + a_3*x + a_4*z + a_5*y*x + a_6*y*z + a_7*x*z + a_8*y^2 + a_9*x^2 + a_{10}*z^2 + a_{11}*y*x*z + a_{12}*y^3 + a_{13}*y*x^2 + a_{14}*y*z^2 + a_{15}*y^2*x + a_{16}*x^3 + a_{17}*x*z^2 + a_{18}*y^2*z + a_{19}*x^2*z + a_{20}*z^3$

6.6.1

As you can see, in total 80 coefficients a_i are used here – each 20 for the polynomials $P_1 \dots P_4$. These coefficients are delivered together with the image data and give an approximation of the exterior orientation. Depending on the satellite (for instance Cartosat-1, Ikonos, Quickbird, OrbView-3) we will use one or more ground control points to improve the orientation (see JACOBSEN 2006, 2007).

After the orientation is carried out for every image the user can go on in the same way like in “traditional” photogrammetry: Object co-ordinate measurements, image matching to obtain a DTM, creating of ortho images and so on. The ground resolution of actual satellite data as well as the elevation accuracy are high. For instance, data from the Cartosat-1 satellite have a ground resolution of about 2.5 metres (panchromatic), the RMS in z can reach a value of about 2 metres as several test have shown.

Stereo satellite images together with RPCs can be processed with the LISA programme FFSAT which was copied onto your PC during the installation. As already mentioned in chapter 2.2, I’ve got the permission to deliver a test data set for this book. Thanks to Mr. Nandakumar from the Signal and Image Processing Area, Space Application Centre, ISRO, India and to Mr. Dabrowski from GEO-SYSTEMS Polska for their help to get these permissions!

So, if you like to see an example, just start LISA FFSAT (Start > Programmes > LISA > FFSAT) and select the project TUTOR_5. This programme is very similar to LISA FOTO, therefore we will only take a look to the main differences:

Instead of Pre programmes > Camera definition you may use File > Select sensor. In our case we use data from the Indian Cartosat-1 satellite. The reference system (ground control points) is UTM, ellipsoid WGS 84, zone 34, width 6 degrees. To

get a “standard” photogrammetric look & feel in the stereo viewing, the images were turned by 90 degrees clockwise – so this option must be activated here. The sensor data file is already prepared for you and is named SENSOR_1.CMR. Also the control point file and quicklooks for each control point are prepared and were stored onto your PC during the installation.

Prepared files: SENSOR_1.CMR, CONTROL.DAT, *.QLK

As mentioned before, the exterior orientation is defined by the RPCs and must be enhanced by the measurement of control points. The RPC data are contained in the files BANDA_RPC.TXT and BANDF_RPC.TXT. If you like you may carry out the control points measurement using Processing > Orientation measurement. This option is quite similar to the measurement of the exterior orientation in LISA FOTO. The example images on CD-ROM (already imported from TIFF, converted from 16 to 8 bit radiometric resolution and contrast enhanced) are named 201.IMA and 202.IMA. Finally, Processing > Define model must be run.

Prepared files: 201.IMA, 202.IMA, 201.ABS, 202.ABS, 201202.MOD

Now the stereo model is ready for use. In particular this means that you can measure 3D co-ordinates and objects in stereo mode using for instance the anaglyph method (option Processing > Stereo measurement, see also chapter 4.5). Further, you can create a surface model by stereo correlation (see chapter 4.6) and an ortho image (see chapter 4.7) – really in the same way as you already know from earlier tutorials. For details please read the relevant chapters in this book or in the programme descriptions on CD-ROM (FOTO.PDF and / or FFSAT.PDF).

6.7

Stereo images from flatbed scanners

From high to low, from very large to small objects... do you have a flatbed scanner? Remember that we already talked about such instruments in chapter 3. There we have used the scanner for what it is constructed: To scan two-dimensional “objects” like aerial photos. In such a case we can simply assume that we have parallel projection.

In this chapter we want to use a flatbed scanner for digitising small 3D objects. Of course the depth of focus is not very large, but if we have objects with a thickness of some millimetres the images will be sharp enough. Before going on let’s look a bit more closer at the geometry (figure 55):

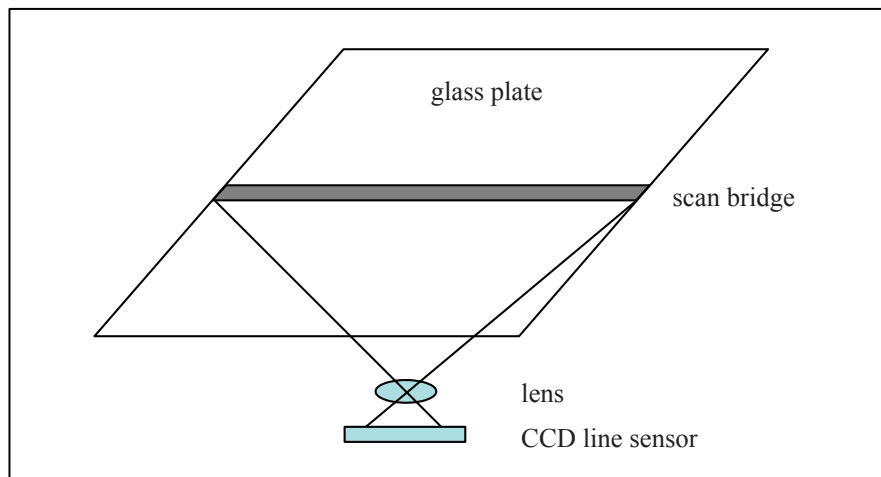

Fig. 55: Geometry of flatbed scanners

Similar to the cameras operated on satellites here we also have central-perspective geometry within the scan line but parallel projection from line to line (along the movement of the scan bridge). In this chapter we don't want to develop a geometric model for 3D measurement but only show how we can use a scanner to construct 3D views using the anaglyph method known from chapter 4.4.

We will use the central perspective within a line in the way that we first put our object near to the left border of the glass plate / scan bridge, then near to the right border. Save both images in a common format like JPG. For the remaining steps we will use LISA BASIC and some tricks:

- Load one of the images into the raster image display. Go to Additional > Info image. In the Geometry section click onto Formal, then OK. Then save the image (File > Save or click onto the diskette button). Now the image is "geocoded".
- File > Edit project, then Reference raster. Load the image, then OK. Now the project area is equal to the image size.
- For both images: Image processing > Image radiometry > Calculation, then Colour image (24 bit) → 3 x 8 bit. Now we have the three base colours (red, green, blue) separated for each image.
- Image processing > Image geometry > Rectification > Image to image. Load the red colour extracts of the first image (formal geocoded) and the second image (in most cases, the red band has a maximum of contrast). Now measure corre-

sponding points in both images, then rectify the second image using the option project limits. For details to this step please look at the programme description of LISA BASIC. If everything is done you have a rectified red colour extract of the second image with the same size (No. of lines and columns) as the first image.

- Image processing > Matching > Others, then 2 x 8 bit → anaglyph image. Use the “formal geocoded” first image and the rectified second image. The result is an anaglyph image which you can view stereoscopic using the red-green glasses.

On the CD-ROM you can find an example (...figures\anagl_3.jpg). The object is a handcrafted golden cross from Katakolon, Greece. The original size is about 27 x 22 mm, the central “rose” has a thickness of about 3 mm. The cross was covered with black drapery to get a dark neutral background, and scanned with 600 dpi.

6.8

A view into the future: Photogrammetry in 2020

Let’s finish our tutorial with some speculative and sentimental words about the future of the fascinating methods we have seen. Will we still need (traditional) photogrammetry in 10 or 15 years? OK, keep in mind that an “old man” talks to you who has written down his experiences of more than 20 years in this field, who is not a photogrammetrist, who is still programming in Fortran, a language which seems to be dead from the viewpoint of young dynamic people...

Every medal has two sides, as we say in Germany, and let’s take a look at both of them:

The first one: We can recognise that satellite-born *image data* available for civilian use increase in ground resolution and decrease in costs since many years. Nowadays, images with and below 1 m ground resolution are available on the market and also stereo images as we saw just before. *Elevation data* of high precision are collected using laser scan techniques, world-wide data sets are offered free-of-charge, for instance the GTOPO30 data, and will be improved more and more, for instance from data collected during the stereo MOMS and the SRTM missions. From this point of view, it is a question if images, taken with aerial cameras operated on airplanes, will have a future. If they are needed, they will be taken with digital cameras, simultaneously registering the projection centre coordinates and the rotation angles (φ , ω , κ) using GPS and IMU techniques. And a dream comes up: A completely, real-time processing of all data “on the fly” – after landing, products like ortho images and elevation data are ready-for-use.

The second one: There exist millions of aerial images world-wide. For any kind of historic evaluation these are of an immense value! Any kind of time-series research will need them. Examples:

- Changing of the size and thickness of glaciers, indicating climatic changes
- Destruction of tropical forest in many countries
- Increase of areas used for settlements and roads
- Reconstruction of destroyed historic buildings
- Detection of dangerous points and areas from (historic) images taken after a war: bombs, mines, destroyed tanks and others

And of course, as we saw, images from digital cameras must be processed in the same way like those from traditional film cameras after scanning. This will be true particularly in close-range photogrammetry also in the future. Concerning the fact that simple photogrammetric work is possible and inexpensive using a standard PC, software and a digital consumer camera, this technique may find a lot of new fields and applications.

Last but not least: New techniques often need years if not decades from the start of development until an operational use! Therefore I hope that many readers of this book may use that what we have learned still in the year 2020...

7 Programme description

In this chapter, a brief description of LISA FOTO and BLUH is given. Of course, most of it you will already know if you have followed our tutorials. Nevertheless it might be good to have a summary for a quick reference. Thanks to Jörg Jozwiak, Berlin, for the translation of this chapter from German to English!

7.1

Some definitions

- In due course co-ordinate values x and y will always refer to a mathematical, left-hand system, that means “ x to the right, y to the top”.
- *DTM* generally refers to a raster image of 16 Bit depth in the LISA format.
- In digital image processing the expression *image co-ordinates* refers to pixel positions (row / column), while in classical photogrammetry it indicates the co-ordinates transformed to the fiducial mark nominal values. For differentiation, the expression *pixel co-ordinates* will be used always and only in the context of digital image processing.
- The area being covered by stereo images (image pair) will be called *model area*.

7.2

Basic functions

As opposed to most digital stereo workstations (DPWS), regarding the direction of the rays, FOTO operates not “top \rightarrow down” but “bottom \rightarrow up”. Its conception is based on a number of reflections undertaken already several decades ago, for example in connection with the development of correlators (see HOUBROUGH, 1978, or KONECNY 1978, for instance). Those ideas find a digital application in this software.

The orientation of the stereo model in FOTO also differs from customary modes. Instead of the classical division into three parts (interior, relative and absolute orientation) it features an independent orientation for every single image. Therefore it does not comprise a relative orientation in a classical sense – following the interior and exterior orientation of every individual image, only a model definition and a parallax correction are being performed (see chapters 4.2, 4.3).

In all programme parts in which you have to measure within a single image or a stereo model, the principle is “fixed measuring mark(s), floating image(s)” like in analytical plotters.

7.3

Aims and limits of the programme

The programme was developed for being used in applications which do not demand high-end geometrical accuracy, namely such as geography, forestry, geology etc. To speak in terms of photogrammetry, (semi-) analytical instruments of second order are to be emulated. The minimum hardware requirements are a customary PC, a simple scanner and a three-button mouse (see chapter 2.1).

For aerial triangulation, a maximum of 200 images per block in a maximum of 10 strips can be handled simultaneously. For image co-ordinate measurement, the number of points are limited to 900 per model and 10000 in total.

The programme version delivered together with this book is limited to a maximum size of 10 MB per image; this allows the processing of standard grey scale aerial photos with a scan resolution of 300 dpi (about 84 μm , see chapter 3.2).

7.4

Operating the programme

The operation of LISA FOTO is generally identical to that of LISA BASIC (if need be, see the programme description). Some functions of the BASIC module most often needed in photogrammetry like the projects' data management have been integrated in the FOTO module for reasons of simplicity.

Each time the name of an (existing) input file is asked the button can be clicked. A file selection window (“file manager”) will then be opened. In general: input- and output files should be given different names. Exceptions are indicated.

Please note that numerical values require a decimal point instead of a comma (for instance: 3.14, not 3,14).

Instead of the button OK offered in each input window the enter (return) key may be used. Instead of the Cancel or Back button it is possible to use the Esc key. In addition, some often used options can be called up directly with the buttons right in the main window or using a pop-up menu: click anywhere in the main windows using the right mouse button and a menu will be displayed providing the options to start the display of a raster image or the text editor.

In the cases where an image or a model is displayed (for example measurement of orientation, image- or terrain co-ordinates), the movement of the image can be done with depressed central mouse button, the arrow keys or by moving the marked area in the overview image. The driving speed can be modified with the corresponding buttons, also form and colour of the measuring mark(s).

7.5 Buttons in the graphics windows

Moving the images: Driving speed relative to the mouse movement



Display of the image parts, stereo model:



side by side left - right



overlaid using the anaglyph method (red-green or red-blue)



line interleaved for shutter glasses, interlaced mode

Size of the display:



reduce



normal size, 1 image pixel = 1 screen pixel



enlarge



centre

Form of the measuring mark(s):



point



cross



cross diagonal



circle with centre point

The buttons below gives the colour of the measuring mark(s): white, black, red or yellow.



Ready



Cancel

7.6 File handling

Starting LISA, a *project* has to be defined. With this, a working directory, an optional image data base, co-ordinate frame (minimum and maximum for x, y and z) and a pixel size will be specified. In the working directory all input files are searched for and all output files are stored by LISA. This way a flexible and clear data arrangement is possible.

The project definition files, in ASCII format, have the extension .PRJ and are located in the programme directory (in most cases c:\lisa).

7.6.1 File > Select project

Corresponds to a new start of the program. Alternatively, the last used project can be taken, one of the existing projects can be selected or a new project can be defined.

7.6.2 File > Define project

The following parameters have to be defined:

- Name of the project: From this, the definition file (extension .PRJ) will be generated.
- Working directory: This can also be selected from a tree diagram using the respective button.
- Image data base (optional)
- Co-ordinate range in x, y and the pixel size (geometric resolution). The button Reset puts this values to maximum possible ones. In such a case the limits of x and y are without any meaning! Optional the limits can be rounded to an integer multiple of the pixel size.
- Co-ordinate range in z. The button Reset puts them to 0 ... 5000 m.
- Length unit (μm , mm, m or km).

The pixel size and the range of the z-values are invariably fixed for all the data of a project! Therefore these values should definitely be chosen carefully!

Optionally, z values can be set equal to the grey values. Then, a DTM will have a height resolution of 1 m. Pixel size and z range are fixed for all data within this project.

The co-ordinate limits can also be taken over from an existing geocoded raster image or a vector file (buttons Reference raster or Reference vector).

7.6.3 File > Edit project

After choosing an existing project, its parameters can be modified.

7.6.4 File > Import raster

The aerial images to be processed must be saved after scanning as 8-bit uncompressed files in one of the formats BMP, JPG or TIF and then may be imported using this option. Consequently *all* images of the working directory (max. 1000) or all *selected* ones (press the Ctrl key in the file manager) will be converted to the LISA internal IMA format (batch mode) keeping the names (for example, 137.BMP creates 137.IMA). Options:

- Turn by 180 degrees.
- Half resolution: For large images. Only every second pixel of every second line will be read out. The size of the file will shrink to a quarter of the original.
- Delete originals: After importing an image the original file is deleted to save space.
- Negative → Positive: Option for inverted originals.
- Numerical output name: With this option for instance the image TEST137A.JPG will be converted to 137.IMA, with other words, only the numerical part of the file name is used.
- 24 → 8 bit.

If the images have a different formats (e.g. RAW) the option File > Import Raster from LISA-BASIC becomes relevant.

Remark: For this option, some functions of the FREEIMAGE library are used. These have the pre-requisite that there is enough main memory because the images are loaded completely!

7.6.5 File > Import Rollei CDW

The following information can be imported from the Rollei CDW system:

- Camera data (file *.IOR): The name of the output file is generated from the camera number. Example: Camera number 35 → file ROLLEI_0035.CMR
- Exterior orientations (file *.EOR): Converted to DAPOR.DAT
- Object co-ordinates (file *.OBC): Converted to GROUND.DAT

7.6.6 File > Combination

If for the scanning of standard aerial images (format 23 x 23 cm) only a A4-scanner is available, the images must be processed in two parts. With the option described here, both parts can then be matched together again (see chapter 6.1).

To do this, the images must be divided with respect to the *flight direction*, so that a left and a right part will be created, not an upper and a lower part! Further it is necessary that both parts have a sufficient overlap. So, put the aerial image on the scanner in the way that the maximum left part will be scanned, following that the maximum right part will be scanned (each time ca. 80% of the total image). Attention: The fiducial marks must be included, whereas the (black) image borders and the side information bar should be ignored.

Names of the image parts: Image number followed by `_L` for the left part and `_R` for the right part, for example `100_L.IMA` and `100_R.IMA`. The option `or all / batch mode` allows the automatic processing of all image parts within the working directory. The original image files (parts) can be deleted automatically to save hard disk space.

Using image pyramids, homologous points will be searched which will be adjusted via an affine transformation. The parameters of the transformation are then used to match the both parts together.

7.6.7 File > Reference list

As mentioned before, normally the principle “image name = image number” should be followed whenever possible. In cases where this is not possible, a reference list must be created which contains the relations between image numbers and names. After the input of these parameters for every image not following this principle, a file called `NUM_NAM.DAT` is created in the working directory.

```
1076 foto76
1077 foto77
1078 foto78
1079 foto79
```

7.6.8 File > Numerical file names

Useful to give all files of a specified type (e.g. `*.IMA`, `*.PIX`) numerical names. If the file name includes a number, this will be taken (say `IMAGE137.IMA` → `137.IMA`), otherwise an increasing number will be used.

7.7 Pre programmes

7.7.1 Pre programmes > Camera definition > Analogue

Preliminary remark: The option discussed here is to be applied in connection with conventional (aerial) photo cameras, providing the original photos were digitised by scanning. After the camera definition for each image an interior orientation has to be carried out (see below). In case the source is provided by a digital camera, the option following next is the relevant one; a measurement of the interior orientation is inapplicable then.

For the interior orientation at least three fiducial marks and the focal length are required. Thus the nominal co-ordinates of between four and eight fiducial marks and the focal length (all in [mm]) must be provided. The data required can usually be drawn from the calibration certificate of the camera. As a rule there are 4, sometimes 8 fiducial marks, at least three of which have to be used. The option to work with just three marks was developed for the case the images was digitised using an A4 scanner. Aerial photos (sized 23 by 23 cm / 9 by 9 inch) can be scanned in a way that the three fiducial marks belonging to the model area are featured. Important: Also in this case, the nominal values of *all* existing marks must be entered! Remark: A better way to use images from an A4 scanner is that described in the chapter File > Combination (see chapters 6.1 and 7.6.6).

The option Distortion opens another window afterwards, giving you several possibilities to take the radial-symmetric lens distortion into account:

- According to the formula $R * (K1 * R^2 + K2 * R^4 + K3 * R^6)$ (approach of BROWN, 1971)
- According to the formula $A1 * R * (R^2 - R_0^2) + A2 * R * (R^4 - R_0^4)$
- According to the formula $K1 + K2 * R + K3 * R^2 + K4 * R^3$
- Use of distortion values from BLUH
- Data from a table

Example for a table with distortion values:

0.0	0.000	each line: radius [mm], distortion [mm]
1.0	0.007	
2.0	0.013	
3.0	0.020	
4.0	0.026	(etc.)

A click onto the OK button store the selected parameters. If no distortion correction should be used, click onto the Reset button.

The specifications will be stored in a file having a CMR extension in the working directory. Example:

```

1  113.000    0.000          fiducial mark 1, x, y in [mm]
2    0.000 -113.000        fiducial mark 2, ...
3 -113.000    0.000          ...
4    0.000  113.000          ...
153.000          focal length
DP  0.0000000000E+00    0.0000000000E+00    distortion
DP  0.0000000000E-02    0.0000000000E+00    ...
PP  0.0000000000E+00    0.0000000000E+00    princ. point
CS  10.000  10.000      160 pixel size, image diagonal

```

If no information about the nominal fiducial mark co-ordinates is available, the option Orientation > Measure > Pseudo camera definition (chapter 7.7.7) can be applied alternatively to set the centred fiducial marks' co-ordinates, converted to [mm], as nominal values.

If the option Distortion was used, additional the file CALIB.IMA is created showing the graph of the distortion function.

7.7.2 Pre programmes > Camera definition > Digital

The subsequent parameters should be obtained from the calibration certificate or the camera manual and be provided: number of columns and rows of the sensor, pixel size in [μm], position of the image principal point (PPS) in x and y (in [mm]; if unknown, each zero) and the focal length in [mm]. If the pixel size is unknown, it can be calculated approximately from the nominal chip size in inch (e.g. 1/2.7"). See also the table in the appendix.

The programme creates two files, one defining the camera as previously described (file extension CMR), the other being universally valid displaying the parameters of the interior orientation. The latter carries the same title as the camera definition file but has the extension INN. The interior orientation process for each individual image discussed below (chapter 7.7.5) can be neglected in this case.

Note: Image data from analogue and digital cameras should be saved in separate sub-directories, the reason being the way in which the programme executes search operations for images' interior orientation:

- a) Search for the file by name <name of image>.INN; if unsuccessful:
- b) If the image number has 6 digits, search for CAMERA_N.INN with N = first digit of the image number (see also option Processing > Image sequence); if unsuccessful:

- c) Search any file with INN extension; if unsuccessful:
- d) Search in the central directory c:\lisa\common\cam.

For distortion correction see Pre programmes > Camera definition > Analogue.

7.7.3 Pre programmes > Control point editor

To create or to edit a control point file. Format: No., x, y, z. Such a file is necessary for example if an exterior orientation is to be produced proceeding from the measurement of at least three points per image (resection in space). Aerial triangulation also requires a control point file, which may be generated here.

Remark: In contrast to two-dimensional orientations and image rectifications like in LISA BASIC, in photogrammetry these options work three-dimensionally. For that, three-dimensional point co-ordinates (with z values) are necessary here!

For the aero triangulation with BLUH, for each control point a factor for the standard deviation in a range between 1 and 9 can be defined. Example: The standard deviation in BLUH was defined as 1 meter for x, y and z. For a control point with problems in x and y, the factor may be set to 5, increasing the standard deviation for this point to 5 meters. For x-y-control points the z-value and the factor for z must be set to 0, for z-control points the x- and y-value as well as the factor for x/y must be set to 0. Example:

80001	260834.230	9361733.530	868.000	1.00	1.00	all used
80002	261034.340	9367396.920	984.000	1.00	1.00	
80003	261536.300	9369026.010	977.000	1.00	1.00	
80004	261782.380	9369459.460	979.000	1.00	1.00	
80005	263033.040	9372566.960	945.000	1.00	1.00	
80006	262483.100	9373364.730	1026.000	1.00	1.00	
80007	0.000	0.000	1020.000	0.00	1.00	only z
80008	258878.000	9375851.000	1595.000	1.00	1.00	
80009	255501.000	9377104.000	0.000	1.00	0.00	only x, y
80010	254537.000	9378764.000	1840.000	1.00	1.00	

If this file already exists, its contents will be displayed. Single entries can be altered, points be added or deleted.

7.7.4 Pre programmes > Strip definition

Many options like the automatic measurement of image co-ordinates for aerial triangulation (AATM) need information about the strips in the block. For each strip, the number of the first and the last image has to be defined; these numbers may have between 1 and 5 decimal digits. Two files will be created, one called STRIP_FOTO.DAT for FOTO and the other called STRIP_BLUH.DAT for the

bundle block adjustment with BLUH. The number of strips which can be defined here is limited to 10.

Example for the file STRIP_FOTO.DAT:

134	140
155	161
170	164

Example for the file STRIP_BLUH.DAT:

0	134	0	140	1	0.0000
0	155	0	161	1	0.0000
0	170	0	164	1	0.0000

The structure of this file is described in the BLOR manual (c:\bluh\text).

7.7.5 Pre programmes > Orientation > Measure > Interior orientation

Important: To begin with take notice of the fiducial marks' position in relation to each other, respectively in relation to the side information bar. An example might help to illustrate the problem: If fiducial mark 1 is, according to the calibration certificate, placed in the middle of the left margin, this will relate to the *original photo*. Depending on the way the photo was placed on the scanner fiducial mark 1 might appear rotated by 90 degrees in the *digital image*, thus be positioned in the middle of the top end margin. In such a case one might, as opposed to the pre-positioning operation (see below), begin with a measurement of the central top fiducial mark, etc., or rather rotate the image in advance (e.g. in LISA BASIC: Image processing > Image geometry > Basic functions > Turn, in this case by 270 degrees).

For every image to be processed an interior orientation has to be carried out previously. After specifying the camera definition file, the fiducial marks defined there will automatically and successively be pre-positioned to their approximate values. The centre of each fiducial mark in question must be brought in line with the measuring mark (one must cover the other) using the middle mouse button depressed or the arrow keys; to digitise the position finally click onto the left mouse button. Note: If the fiducial marks (usually little white dots) are hard to identify, it might be helpful to optimise the display using the brightness / contrast regulators. Points impossible to measure (invisible or outside of the image) can be skipped by clicking onto the right mouse button or the appropriate button on the screen.

If the option Subpixel improvement is activated, the programme will find the position using the maximum grey value in the surrounding of the clicked pixel. Using this and the neighbouring grey values the subpixel co-ordinates will be cal-

culated by linear interpolation. Therefore it suffices to hit the mark “more or less” – the centring operation will follow automatically. This procedure may however only be applied in connection with point-shaped white marks! Alternatively, choose a rather great enlargement, then measure the fiducial marks manually as exact as possible, disregarding the option Subpixel improvement.

In case an image rotated by 180 degrees should be processed in this position (which is the case with normally every second photo strip resulting from the meander-like flight), the corresponding option is to be selected. The fiducial marks will also be rotated by 180 degrees, thus they are pre-positioned in the order given by the camera definition.

Transforming operations between nominal co-ordinates (x, y in mm) and the pixel co-ordinates (column, row) of the fiducials employ a plane affine transformation. For more than three fiducials a least squares adjustment is performed and the residuals in [mm] are displayed. This allows extreme values (peaks) to be marked and deleted from the calculation (button (De)activate) and fiducials to be measured anew. If you are satisfied with the result click onto the Ready button – this will save the ascertained parameters.

For control, the calculated scan resolution in [dpi] as well as in [μm] will be displayed. If these values differ significantly from the real ones, the fiducial mark’s nominal co-ordinates may be wrong.

The data will be saved in a file within the working directory, carrying the same name as the image file but the extension INN. Example:

0.1404250000E+04	0.1181858407E+02	transf. parameters	
-0.9734513274E-01	0.0000000000E+00	...	
0.1399000000E+04	0.9734513274E-01	...	
0.1175221239E+02	0.0000000000E+00	...	
1	2740.000	1410.000	fiducial marks,
2	1415.000	71.000	pixel co-ordinates
3	69.000	1388.000	...
4	1393.000	2727.000	...
CAMERA_1.CMR		camera defin. file	
153.000		focal length	

The transformation parameters refer to the transition from pixel to nominal image co-ordinates.

Note: Form and size of the measuring mark should be adopted to the fiducial marks!

7.7.6 Pre programmes > Orientation > Measure > Exterior orientation

If the results of a triangulation with BLUH or BINGO are on hand, no exterior orientation needs to be executed – adopting the parameters from the corresponding file (normally DAPOR.DAT) will establish the orientation. In case the parameters of the exterior orientation are available by other means, they may be entered directly (see chapter 7.7.9). This is sometimes advisable if oblique images shall be oriented.

If just at the beginning the error message “Portrait ↔ Landscape?” appear, this refers to the camera definition or to the interior orientation. For instance, in case of a digital camera it can be possible that within the camera definition the numbers of rows and columns of the sensor were mismatched.

Otherwise a resection in space has to be carried out for each individual image. After the interior orientation of the image and the generation of a control point file (if not existing already; see chapter 7.7.3) the following steps are required to be undertaken for each control point:

- Select (mark) the point which shall be measured in the list below, click onto the button Measure.
- Adjust the point by shifting the image section with the central mouse button depressed or the arrow keys until the point and the measuring mark are precisely aligned one over the other
- Digitising (by clicking with the left mouse button)
- After a successful measurement the point and its number will be displayed in the image and marked with M in the listing below.

Note: It is a good idea to start with three or four well distributed, non-collinear points near to the image corners, in this way helping the orientation algorithm to converge.

In case exterior orientation data of the current image is available from a previous measurement the programme offers the option to adopt it. All points measured already will be displayed both in the image and in the overview image. To make it easier finding a point, optionally a neighbourhood of 121 x 121 pixels of the point can be stored. Choosing this option, the image part will be contrast enhanced and stored as a small image file, a so-called point sketch (quicklook). The file name has the form <point number>.QLK. If such a sketch already exists for a selected point, it will be displayed during the point measurement.

More than three control points produce an over-determination. As has been described already in connection with the interior orientation above, a least squares adjustment and an indication of residuals with the option to mark and to delete points falling out of the defined limits will also be carried out in this place (button (De)activate). As a rule as few points as possible should be deleted and an equal

distribution of the points in the image should be maintained. After four measured control points, any further point now will be pre-positioned in its approximate position.

If you are satisfied with the result, finally click the Ready button – this will save the determined parameters.

The focal length and the computed orientation parameters (X_0 , Y_0 , Z_0 of the projection centre in [m], the rotation angles φ , ω and κ in radians and the focal length in [mm]) will be saved in a file within the working directory, carrying the same name as the image file but the extension ABS. Example:

```

153.000                                focal length
      .008                .006          1.587           $\varphi, \omega, \kappa$ 
1136701.547  970322.348    5289.731           $X_0, Y_0, Z_0$ 
120011 -108.016  70.005  2548514.900  5689958.100  38.200
120072 -96.000  -8.455  2548720.500  5688872.700  41.600
120122 -69.805  -66.654  2549108.300  5688075.100  31.200
...

```

(... image and terrain co-ordinates of all measured points)

Remarks to the option Adjustment of focal length: Pre-requisite are enough well-distributed special control points. In particular, these should not all be situated in a plane but must have a sufficient range in all three co-ordinate components (x , y , z)! If now after finishing the measurements the Ready button is clicked, the focal length will be calculated, and the value set in the camera definition as well as the calculated one are shown. With a click onto OK the calculated value will be selected and used for all following steps.

To control the results, please note the following:

- In case of aerial / vertical images, the absolute values of φ and ω are usually less than 1.
- κ shows the flight direction – east having the value 0 and the angle is being issued left turning, so representing north as ca. 1.57, west as ca. 3.14, south as ca. 4.71.
- The height of the projection centre (Z_0) is the sum of the terrain- and the flight height (height above ground, h_g).
- The standard deviation of the residuals at the control points should not be more than one pixel. The pixel size results from the photo scale and the scan resolution (analogue images) or was defined within the camera definition (digital) as pixel size of the sensor.

7.7.7 Pre programmes > Orientation > Measure > Pseudo camera def.

In case no information about the nominal co-ordinates of the fiducial marks is available and thus no camera definition files could be produced, the option described here may be used as a substitute to do so. The resolution of the scanner in [dpi], the focal length in [mm] and the name of the output file has to be specified. As described above (interior orientation, see chapter 7.7.4), the option Subpixel improvement is also applicable here.

To reach a maximum of accuracy, *all* fiducial marks should be measured in the actual image! An incomplete image, for example only containing 3 marks, is not good for a camera definition and for further evaluations.

Subsequently 4 to 8 fiducial marks are to be measured. The software presupposes that the co-ordinates' x- and y-axis defined by the fiducial marks are rectangular with respect to each other. At least two opposite marks must be symmetrical with respect to the centre (intersection of the x- and y-axis). Under these conditions the measured fiducial marks' co-ordinates are being centred and converted from pixels to [mm]. After measuring the last fiducial mark click onto Ready – the results will thereby be stored as a camera definition file. Regarding the structure of this file see the option Pre-programmes > Camera definition > Analogue (see chapter 7.7.1).

Note: The procedure described here must be regarded as an exceptional case – making use of real nominal co-ordinates drawn from a calibration certificate will by all means lead to more accurate results! On the other hand, using the additional parameters in BLUH, remaining errors can mostly be eliminated, since all following measurements in images taken with this camera will be converted to these same nominal co-ordinates.

7.7.8 Pre programmes > Orientation > Measure > LICAL

Option for the calculation of the radial-symmetric lens distortion. You need the LICAL calibration plate.

Take a photo from the calibration plate in the way that the plate nearly fills the whole image format. Make sure that all of the 77 target marks are within the image. Also take care of a good illumination and a steady hand.

The programme starts near to the lower left image corner. Measure the first four target marks manually (lower left, lower right, upper right, upper left). Measure the first mark with special care, because from this position a small part of the image is stored and used as a reference for the following marks. The other marks will be measured automatically. At the end of the measurement, the number of measured points is displayed (normally 77). Now click onto OK. With this, the calculation of the radial-symmetric lens distortion and the principal point starts.

The results of the measurement are stored in a file with the name of the camera and the extension CAL (example ROLLEI_DP3210.CAL). Now start again the option Pre programmes > Camera definition and activate the option Distortion. In the next window just click onto OK. The result can be viewed in a graphics called CALIB.IMA.

7.7.9 Pre programmes > Parameters of the exterior orient. > Manual

If the 6 parameters of the exterior orientation are already known, they might be entered directly here. The order of the angles φ , ω , κ during their calculation must be recognised – you may know, that the *values* of these angles depends on the *sequence* of their calculation! In LISA, BLUH and BINGO the order is $\varphi - \omega - \kappa$. If the angles were calculated in the order $\omega - \varphi - \kappa$, please activate the corresponding option.

The focal length is to be provided in [mm]; the three angles in grads (new degrees, full circle = 400 grads), degrees (full circle = 360 degrees), radians (full circle = 2π) or mils (full circle = 6400[˚]) and the co-ordinates of the projection centre in [m].

The data will be saved in a file carrying the same name as the image file and the extension ABS. For the structure of this file see the chapter 7.7.6.

7.7.10 Pre programmes > Parameters of the exterior orient. > Import

Alternative to the option before, in case the parameters of the exterior orientation are available in a file. The entries there must be stored in the sequence image number, rotation angles (φ , ω , κ or ω , φ , κ), projection centre (X0, Y0, Z0).

7.7.11 Pre programmes > Parameters of the exterior orient. > BINGO

The BINGO output file ITERA.DAT contains among others the parameters of the exterior orientation as well as the adjusted co-ordinates of the control and the connection points. To be able to work with them in FOTO they have to be imported using this option. The file ITERA.DAT will then be split up into two separate files, containing the orientations (default name DAPOR.DAT) and the co-ordinates (default name DAXYZ.DAT). For BINGO version 5 or higher.

7.7.12 Pre programmes > Select model

For the case that several models have already been defined (see next chapter), one of them may be selected here. Otherwise the latest active model will be used automatically. The model currently active is being indicated on the status line in the lower part of the screen, the last one used will be saved in a file called STEREO__PRD within the working directory.

7.7.13 Pre programmes > Define model

This option requires the following specifications for each model (stereo-image pair) to be evaluated: Number of the left and the right image, width of the border in pixels and the method of exterior orientation:

- If using the parameters from BLUH or BINGO, the corresponding file must be provided containing the orientation parameters (default: DAPOR.DAT). In this case the file with the adjusted terrain co-ordinates (default: DAXYZ.DAT) may be used as the object co-ordinates file.
- If the parameters were entered manually (see option Pre-programmes > Parameters of exterior orientation, chapter 7.7.9) or created by a resection in space (see option Orientation > Measure > Exterior orientation, chapter 7.7.6), ASB files were created and must be used here.

As an option, all models of the block as given in the strip definition (see chapter 7.7.4) can be operated one by one (batch mode).

If the input window already contains data of an existing model, the image numbers can simply be switched using the resp. buttons. A test image named MOD_TEST.IMA can be generated to obtain optical control; it illustrates the relative position of both images (model) and the positions of the “certain points” used with the parallax correction.

The stereo model comprises two kinds of parallaxes. The x-parallaxes are primarily a result of the relief-induced radial-symmetric shift of the location of an object and are necessary to determine the height of it. In the complete and precisely orientated model there are no further parallaxes – so far the theory. Practically there might be parallaxes also in y direction ranging from 1 to 5 pixels, caused by inaccurate scanning, inaccurate nominal values of fiducial marks and control points, inaccurate measurements of the interior and exterior orientation and other reasons, which afterwards appear to be disturbing during manual evaluation measurements or the automatic DTM generation (matching). The option described here can reduce those remaining y parallaxes by an affine transformation or 2nd order polynomials.

Initially the programme reads all available points within the model range – these are the points given in the object co-ordinates file (e.g. DAXYZ.DAT). A correlation will be performed on these points regarding the given maximum y parallax. From the differences between the nominal y co-ordinates and the co-ordinates found by the correlation the transformation parameters in row- and column direction will be deduced, provided that in more than three points the correlation’s threshold value have been reached. If not, a warning message appears (“Parallax correction impossible”).

An additional remark concerning the parallax correction should be given here: If only few points at a small distance with respect to each other exist, the correction might be de-activated. On the other hand, if many well distributed points exist and the images have greater non-linear distortions (e.g. coming from a simple digital camera), the option polynomials should be used for correction.

The programme will now calculate values for the co-ordinate range of the model which may be altered in the following window. The height range (z_{\min} ... z_{\max}) and the pixel size will be taken from the project definition and cannot be changed because these values are fixed within the project. The calculated proposal values x_{\min} , x_{\max} , y_{\min} and y_{\max} will be limited to the values set in the project definition. Important (!): Within the model area which is to be fixed here, there must exist at least one point (from the object co-ordinate file)! The parameter Border size refers to the border size of the raster images in pixels, which will be disregarded for instance in the stereo correlation process (see chapter 7.9.3).

Note concerning the object co-ordinate file: Besides single points, this can also contain break lines and polygons for free-cut areas. These are defined via codes in the same way like in LISA BASIC (see that manual or the appendix, part 1). If at this moment no object point file exists, the respective entry in the input window may keep empty. Then, ignore the error message "No point found in the model area!". But, because of the fact that at least one point is necessary for all further processing, go immediately to the stereo measurement, digitise some well-distributed points and repeat the model definition with these points.

For your information, some additional parameters are calculated and displayed:

- The (approximate) pixel size of the input images in terrain units: this value can serve as point of reference for the pixel size in the project, for example for a DTM or ortho image, using the stereo correlation. The pixel size (geometric resolution) of such secondary products should exceed the one given for the original image source.
- The ratio distance/base: the higher this value, the less certain is the measurement of elevations.
- The maximum definition accuracy to be achieved depends on these parameters.
- The mean photo scale (in case of scanned analogue images).
- Number of certain points: The minimum amount is the number of given object points within the model area. The larger this value, the better the parallax correction may be.
- The mean y parallax detected at the certain points before and after correction. The lower this value, the better should be the image orientations and the less significant might be the image distortions.

- The mean correlation coefficient at the certain points. This value may serve as point of reference for the threshold value which has to be defined within the stereo correlation module (see chapter 7.9.3).

The data will be saved in a file whose name is constituted by the left and the right image number and which carries the extension MOD. Example, file name 135136.MOD:

135	136		Image numbers
DAPOR.DAT			File with orientations (*)
DAXYZ.DAT			Object co-ordinates file
1135300.000	1138000.000		Model range in x [m]
969300.000	971482.000		Model range in y [m]
100	0.945	11	Border size [pxl], mean corr. coeff.
0.9538237356E+03	-0.1383532837E-02		coefficients py0, py1
0.6379042187E-03	0.0000000000E+00		py2, py3
0.0000000000E+00	0.0000000000E+00		...
0.0000000000E+00	0.0000000000E+00		

(*) If the orientations are taken from ABS files, this line keeps empty.

Note for control:

- Error message “Orientation not OK!”: The programme undertakes a test on plausibility, in which the connection between terrain and pixel co-ordinates is checked. Possible causes for faults: At some point the values of x and y were interchanged. Or: In a manual input of the parameters of the exterior orientation (see above) the angles were not provided in selected units.
- Error message “No point found in the model area!”. It is possible that there is in fact no point in the model area. Then at least one must be measured (e.g. using Processing > Stereo measurement), or the co-ordinate range of the model has to be extended. Another reason might be a poor interior and/or exterior orientation – these should be controlled accordingly.
- Another error source can be the activated or not activated parameter Turning by 180 degrees in the interior orientation (see there).

7.8 Aerial triangulation measurement (ATM)

Some pre remarks about the image and point numbers:

Image numbers: All images within the block must have a unique number! If images of different years or flights are used, it might be that some image numbers appear twice. In this case, the numbers must be changed strip wise, for example from 712 ... 722 to 1712 ... 1722. Image numbers must have 1 to 5 decimal digits for the use in LISA.

Point numbers: Like before, also object points must have each a unique number! The automatic numbering in the manual or automatic measurement (see chapters 7.8.1, 7.8.5) uses the image numbers and a consecutive index – for example, points within image No. 712 will get the numbers 712001, 712002, 712003 and so on. During the manual measurement of connection points (see chapter 7.8.4) numbers like 777770001, 777770002 etc. are created. This must be taken into account when numbering the control points! If, for instance, all images of the block have a three digit number, the control points may be named 1001, 1002, 1003 etc. without any conflicts with other object points.

7.8.1 ATM > Manual measurement

With this module image co-ordinates can be measured for the aerial triangulation in BLUH or BINGO. To do so a camera definition is necessary, further more the interior orientation of all images must exist.

Remark: Having good image material, an automatic measurement may be carried out instead (see below). But even then, the option described here has to be used to measure the control points or additional tie points. Per model, a maximum of 900 points can be measured.

Both image numbers, the approximate longitudinal overlap of the model (“end lap”, mostly around 60% or 80 %) and the name of the output file must be provided. If the input window already contains data of an existing model, the image numbers can simply be switched using the resp. buttons. The parameters will be saved in the BIKO____.PRD file within the working directory. As already mentioned above within the exterior orientation (see chapter 7.7.5), also here exists the option to store neighbourhoods of measured points as point sketches to help finding the exact position within further measurements.

If a file exists containing the orientation parameters (or approximate values of them) and also a file with the ground co-ordinates of the control points, then these

files may be defined. Then, measuring a control point, the corresponding positions in the left and the right image will be set automatically.

For technical reasons the models of one strip should always be worked on starting on the left proceeding to right. This means that for the first model the left and the neighbouring right image of a strip should be taken, then in the next model the former right becomes the current left image and so on.

Display of the images

From the left respectively the right image, a part can then be displayed on the screen in three variations:

- Neighbouring left – right
- Overlaying each other, colour coded following the anaglyph method
- Line interleaved for shutter glasses, working in interlaced mode

Trained users are able to see the first display mode in three dimensions. Less trained users should select the alternative method, namely observe the situation through red-green glasses (green filter on the right side). The shape and colour of the measuring marks, under which the image parts are moved, may be altered using the corresponding buttons. An overview image with a rectangle showing the actual position facilitates the coarse positioning within the model. The image display can be performed in several sizes (zoom; 10% ... 8000%); the brightness can be regulated separately for the left and the right image (Anaglyphs: intensity of the red and the green channel).

Roaming in the model

The mouse executes the movement in x-y-direction; the central mouse button is to be held pressed down. Should any difficulties occur (e.g. only a two button mouse is available or a wrong driver installed), the left and the right button depressed simultaneously or the F1 button can be used instead. The roaming speed can be set using the corresponding buttons. In addition, for precise positioning the arrow keys may be used.

The left and the right image are normally linked together. To shift the x- and y-parallax the right mouse button has to be held down. In this case only the right image will be moved. As soon as it is brought in line with the left image (parallaxes moved away), the programme may attempt to maintain the correct junction by permanent correlation while the image is moved: Choose the option Correlation on.

Further more the button Go to allows a direct positioning in the left and the right image by a manual input of pixel co-ordinates. The option Correlation (F2 key) calculates the correlation coefficient for a 21 by 21 pixel neighbourhood of

the point in question – if the value is at least at 0.7, the right image will be moved to the corresponding position.

Point measurement

There are four options to measure image co-ordinates (select Measure > ...):

- From model before
- Gruber points
- Individual
- Grid

The registration of the image co-ordinates will be carried out with a click onto the left mouse button after the left and the right image part are set to corresponding positions. The options:

From model before: Two cases are to be distinguished: (A) Points that have been measured previously in the present model, will be displayed coloured blue in the overview image and can not be measured anew. Should a point be measured again it is to be erased with the help of the editor for ATM points (see next chapter). (B) For points that have already been measured in the (now) left image of the actual model the programme will estimate considering the side lap, if they may possibly also be present in the right image. If this is the case then the programme will mark these in green in the overview image and will automatically set them in the left image; their position is fixed here (automatic point transfer). Accordingly, just the corresponding position in the right image is to be set manually. This option can and should be used from the second model onwards in the strip. If it is not possible to measure a point, the Skip button or the F3 key may be used.

Gruber points: To connect both images, at least 6 well-distributed points of the model have to be measured. From the second model onwards the three ones on the left side have already been measured in the previous model and can therefore be adopted. The default distribution is similar to the “six” on a dice, which means two points on the top, two in the middle and two on the bottom of the model. The programme sets those positions automatically and provides point numbers, which are extracted from an increasing index and the left image’s number. Example: Left image number = 747, then the point numbers will be set to 747001, 747002, 747003, 747004, 747005 and 747006. In the case that a point cannot be measured, the button Skip may be used or alternatively the F3 key.

Individual: After entering its number a point will be checked for in the output file, to find out whether it has already been measured in the left image. If it has, a pre-positioning will be performed in the left image as described above (*From model before*). Otherwise the point is to be adjusted freely in both image parts. If it turns out that the point cannot be measured after entering its number, the Skip

button or the F3 key can be applied again. To finish the measurement, use the Finish button.

Grid: After defining the grid width in [pxl], the model will be pre-positioned to all grid points.

Remarks concerning all measuring methods:

- The option Skip may be also called up using the F3 key
- The button Ready terminates the relevant module. Afterwards starting one of the Measure options continue the process.
- The Measure > End option (or the Esc key) causes the measurements to be stored and the module terminated.

Position and number of each point will be superimposed into both image parts; additionally they will be marked red in the overview image. Pixel co-ordinates are stored with the row co-ordinates being mirrored – the origin therefore lays in the left bottom corner. The first line of each model includes the image number, the focal length and the camera name. The next lines includes the fiducial marks (co-ordinates of the interior orientation), followed by the values point number, x left, y left, x right, y right for each point which was registered. The end of a model is indicated with -99.

For a further application in BLUH or BINGO the file must be exported after the completion of all measurements with the help of the option ATM > Export > BLUH (see chapter 7.8.7) respectively ATM > Export > BINGO (see chapter 7.8.8).

Example for the output file:

```
135000136    153.000 RMK_1523.CMR
      1  2735.016  1389.988  2739.972  1410.063
      2  1406.985    54.021  1414.941    71.033
      3    64.970  1376.988    68.940  1388.030
      4  1392.022  2713.022  1393.045  2726.955
135001  1426.000  2551.000    585.000  2552.000
135002  1426.000  1417.000    540.000  1417.000
135003  1426.000    284.000    587.000    272.000
135004  2500.000  2543.000  1765.000  2560.000
135005  2598.000  1402.000  1856.000  1402.000
135006  2620.000    284.000  1842.000    252.000
      -99
```

7.8.2 ATM > Editor ATM points

After providing the input file, all previously measured points are displayed in ascending point number order. After marking (clicking onto) a point in the list window, its number may be changed. The single point or all points with the same number can be erased using the respective Delete button. Doing this, the number will initially be set to its negative value, the deletion can therefore be reversed by repeated marking and erasing (the point number will return to its original value). Furthermore, an existing point sketch can be deleted here.

Using the Ready button causes the file will to be actualised and stored, points with negative numbers will thereby be deleted.

Remark: This option can be used for files with a maximum of 20000 points.

7.8.3 ATM > Calculate strip images

This option is a pre-requisite for the measurement of connection points like described in the next chapter and especially necessary if the block contains more than one single strip.

The strip definition (see chapter 7.7.4) must already exist. For each strip of the block a special image is calculated containing the single images in a size of each 300 by 300 pixels side by side in the sequence in which they form the strip. The name of the output image is derived from the number of the first and the last image. Example: First image No. 134, last image No. 140, then the output file has the name ST_134140.IMA.

7.8.4 ATM > Measure connections

With this option, connections points (tie points) between neighbouring images and strips can be measured, serving as initial values for the automatic measurement (AATM, see next chapter). If the block consist of only one strip, you may go directly to the next step.

Load the first strip into the upper part of the window, the next strip which has a lateral overlap (side lap) with the first one into the lower part of the window. The brightness can be adjusted for each strip, the strips can be moved independently with the mouse, middle button depressed, and set back to the start position using the button Pos 1. Now click onto Measure and define the name of the output file, default is TIEPOINT.DAT. Digitise the first connection point by clicking the left mouse button in *all* images in which it appears, after that click onto the right mouse button. The point will be registered, marked in all images with a small red square and labelled with an increasing number. Now digitise, if necessary after moving the strips, the next point in all images, then press the right mouse button, and so on.

Measured points can be (de-)activated within the point number list. After a click onto the respective button, the point number is set to a negative value. A second click will reset the number to the initial value. Points with negative numbers (de-activated) will not be stored in the output file.

Finish the measurement with the button Ready / End.

Here some additional remarks:

- The *control points* necessary for aerial triangulation of course must be measured in the original images at highest resolution (ATM > Manual measurement, see above). However, the *connection points* measured as described here are only used as initial positions.
- If, as a result of a large number of well distributed control points, a sufficient connection between neighbouring strips is already given, the separate measurement of connection points may be not necessary. It is also possible to measure some connection points only in areas with few control points.
- If the block consists of only one single strip, but the images are of bad quality or very low contrast, you can often get better results from the automatic measurement if you measure some connection points manually.
- The more connection points are located in the block, the more stable the strip connection will be! As a basic rule, *each* image should have at least one common connection point with *each* neighbouring strip.
- And of course only those points can be used for connection which appear in at least two neighbouring images (model) per strip.

Example of the output file:

777770001	210.000	250.000	134
777770001	115.000	255.000	135
777770001	26.000	254.000	136
777770001	211.000	56.000	155
777770001	121.000	49.000	156
777770001	19.000	59.000	157
777770002	227.000	242.000	135
777770002	140.000	242.000	136
777770002	41.000	246.000	137
777770002	240.000	37.000	156
777770002	139.000	48.000	157
777770002	42.000	53.000	158
...			

First column = internal point number, second column = x value, third column = y value (each times pixel co-ordinates, measured in the 300 by 300 pixel images), fourth column = image number.

7.8.5 ATM > Automatic measurement (AATM)

For the processing of aerial images; if the images are located in different strips, these should be in a parallel arrangement.

The following steps must already be carried out: Camera definition, interior orientation of all images, manual measurement of the connection points (especially when the block contains more than one strip, see above), manual measurement of the control points (see chapter 7.8.1). Threshold values for the correlation coefficients and the correlation window sizes (each for approximation and improvement) must be set. The option adaptive leads to an automatic setting of the correlation coefficient in any model (see below). Further, a border must be defined (size in pixels) which will not be taken into account. The control points file, the connection points file (optional) as well as the output file has to be defined.

In a more or less regular distribution connecting points will be searched automatically and also transferred into the following model, if possible. As usual, this is done using image pyramids to get even better results beginning with a coarse approximation.

In each image, points are searched within a regular grid of 30 by 30 squares. As a result, the maximum amount of points depends on the longitudinal overlap in % – for example, an overlap of 60% will give a maximum of 60% from 900 points = 540 points. At the beginning, within the squares areas of maximum contrast are searched, defining the position of a point in the left image. Then the homologous point in the right image is determined via correlation. When this work is done in the actual model, a plausibility control is carried out concerning the x and y parallaxes to delete obviously wrong points. After this, a second approach is made using the improved approximations, then the programme goes on with the next model.

After all images are processed within the first pyramid level, a block adjustment is carried out. For this, the module BLOR from the programme system BLUH (author: Dr.-Ing. Karsten Jacobsen, IPI University of Hannover) was modified and integrated into LISA FOTO. Beneath some tests concerning all points just found, the results of the block adjustment serve to find all images in which a point may appear. Starting with this information, an automatic improved strip connection is done.

Following the output file with the pixel co-ordinates of all measured points, a protocol file named AATM.TXT is created and displayed at the end of the work.

The output file then is converted into the BLUH format with the name DAPHO.DAT (see option ATM > Export > BLUH; respectively ATM > Export > BINGO). A final block adjustment with BLOR creates the files AATM_AOR.DAT (orientation parameters) and AATM_ATC.DAT (object co-ordinates). In many cases, these results may already be exactly enough. Otherwise, now a complete bundle block adjustment should be carried out.

Remark: If, in seldom cases, additional connection points must be measured *afterwards* using the ATM > Manual measurement option, the file described before (standard AATM.DAT) should be used for output, choosing the option Append when the warning message “File already exists” appears. In this case, the export to BLUH or BINGO must be started afterwards.

Next step: Pre programmes > Define model, then activate the option all.

7.8.6 ATM > Import > IMATIE

For the import of pixel co-ordinates from the measurement tool IMATIE (extension PIX). These are stored in a single image mode (one PIX file per image) and can be imported strip-wise into the internal FOTO format, described in chapter 7.8.1.

Remark: The programme IMATIE, written by Dr. Michael Braitmeier from the University of Düsseldorf, is not part of LISA but compatible to it. Within IMATIE, pixel co-ordinates can be measured manually in up to 6 images simultaneously. If need be, please contact the author for more information.

7.8.7 ATM > Export > BLUH

Input: File with the pixel co-ordinates from a manual or automatic measurement in LISA. The pixel co-ordinates are transformed by a plane affine transformation onto the fiducial marks' nominal co-ordinates of the camera definition, becoming image co-ordinates. Example for the output file:

```

135000136    153.000
  13502      2.778    99.217    -68.507    98.679
  13503      2.238     2.836    -73.106     2.136
  13504      1.698   -93.460   -69.928   -95.321
  13505     93.678    98.093    31.333    98.531
  13506    101.429     1.076    38.225    -0.064
  13507    102.759   -93.954    36.238   -97.904
    -99

```

7.8.8 ATM > Export > BINGO

Input: File with the pixel co-ordinates from a manual or automatic measurement in LISA, file with the object co-ordinates of the control points. The pixel co-ordinates are transformed by a plane affine transformation onto the fiducial marks' nominal co-ordinates of the camera definition, becoming image co-ordinates. Example for the output file:

```

135
13502    2.778    99.217
13503    2.238    2.836
13504    1.698   -93.460
13505    93.678   98.093
13506   101.429    1.076
13507   102.759  -93.954
-99
136
13502   -68.507   98.679
13503   -73.106    2.136
13504   -69.928  -95.321
13505    31.333   98.531
13506    38.225   -0.064
13507    36.238  -97.904
-99

```

Furthermore, using the object co-ordinates of the control points, the BINGO parameter files GEOIN.DAT and PROJECT.DAT will be created (see chapter 5.2.5).

7.8.9 ATM > Export > IMATIE

Exports pixel co-ordinates from FOTO into the format of the measurement tool IMATIE. All information of the input file are converted so that for each included image a file with the name of the image and the extension PIX is created.

7.8.10 ATM > BLUH graphics

A raster image will be created. According to your choice, this can contain:

- Position and number of the control points, error vectors
- Position of tie points
- Centres, numbers and borders of the images

As usual, the pixel size will be taken from the project definition. Because this may lead to an unnecessarily large file, the pixel size may be increased. Further, the image may be limited to the co-ordinate frame given in the project definition.

7.9 Processing

7.9.1 Processing > Stereo measurement

This module allows object co-ordinates to be measured in an orientated stereo model with an optional linked DTM. The camera definition, the interior and exterior orientation of both images as well as the model definition must already exist. Besides that a DTM should be available for the model area.

Note: If a DTM does not exist, it is possible to begin with the starting height which should be equivalent to the average terrain height. However, some of the following options become inapplicable then.

Display of the images

Identical to the display in the module ATM > Manual measurement (chapter 7.8.1, see there).

Roaming in the model

The mouse executes the movement in x-y-direction; the central mouse button is to be held pressed down. Should any difficulties occur (e.g. only a two button mouse is available or a wrong driver installed), the left and the right mouse button should be pressed down simultaneously or, alternatively, the F1 button will have the same effect. The corresponding buttons permit the adjustment of the roaming speed. In addition, for precise positioning the arrow keys may be used. The smallest step range (lowest roaming speed) is equivalent to the pixel size set in the project definition, respectively the pixel size of the DTM.

Navigation in z direction is also mouse-controlled and requires the right mouse button to be pressed down. If a central mouse wheel exist, the height can also set with this. While navigating over the model either the last fixed height may be maintained (button Z ---), or the height of the connected DTM can be adopted permanently (button Z = DTM).

The Go to button allows a point to be positioned directly by manual input of its terrain co-ordinates. The Centre button resets the current position to the centre of the model. The option Correl.coeff. acts to calculate the correlation coefficient for the current position of the left and the right image.

Modes of measuring

The registration (digitalisation) of data is executed by the Digitise option. Three-dimensional terrain co-ordinates can be registered (= object co-ordinates; No., x, y, z). One of three alternative ways may be selected:

- Points / lines: Manual positioning and digitalisation of points and lines. As an option a subsequent pre-positioning is carried out regarding the points of an input file, provided they lie inside of the model range. For pre-positioning the z-values of the input file can either be adopted or ascertained from the DTM being the base of the operation.
- Profile: The pre-positioning will be carried out after entering the starting and the final point as well as the step range (interval).
- Grid: The pre-positioning will be carried out after entering the co-ordinate area and the width of the raster; the defined area will be covered step by step beginning with the lowest x and y value. As an option, positions with known DTM heights can be skipped automatically (Only in gaps).

Note: Pre-positioning has the effect that the x-y-values of the actual point cannot be changed – only the altitude can be set using the mouse, right button depressed.

In all cases the point code must be defined. Codes from 1 to 5000 are used for single points, codes from 5001 to 9999 for lines. For further details see the LISA BASIC manual or the appendix, part 1. The digitalisation can be aborted with the Cancel button. If a pre-positioning takes place and the point in question cannot be measured stereoscopically there are two alternatives: Using the Skip button (or F3 key) causes the direct continuation of the process with the next point leaving the one in question unregistered. Alternatively, the z unknown button (or the F4 key) stores the point with a z value of -999. Sketch creates a point sketch with the number to be defined.

Note: Three-dimensional point co-ordinates in single point, profile or grid order can also be produced directly from the DTM with LISA BASIC, using the option File > Export raster image > DAT / vector (see chapter 4.7.5).

Overlay > DTM points: This option is useful for example in combination with the stereo correlation (see next chapter). If the option Interpolation of missing points was deactivated and a more or less incomplete DTM created by matching, DTM points which are determined by the correlation can be projected in the left and right image. In areas with big gaps, additional points should be measured manually (previous option Digitise) and subsequently this incomplete DTM and the file containing the additionally measured points should be combined into a complete DTM using the option Processing > DTM interpolation (see chapter 7.9.4). Note 1: The DTM on / DTM off button in the overview window allows DTM points to be superimposed

there. Note 2: The points are superimposed in red. Therefore, the colour of the measuring marks may be set to yellow.

Overlay > Vector data: Projects the content of a vector file to be provided into both images as well as into the overview window (superimposition). Attention: For the transformation from terrain to pixel co-ordinates the z value from the vector file is used, not the height of an optional loaded DTM.

Overlay > New drawing: This undoes the options above by reading the images anew which might require some time.

And here is a tip: Eventually, you may be uncomfortable to work always with three changing mouse buttons – the central button for moving the model, the right to set the elevation and the left to register the co-ordinates. For this, here are two suggestions:

- In any case, make sure to have a DTM, for example using the stereo correlation (see next chapter), and start the stereo measurement with it. Now it is not necessary to set the elevation.
- If you digitise points without a pre-positioning, just keep the F1 key depressed. With this, the model follows the mouse movement (like you would press the middle mouse button), and you only use the left mouse button for registration.

Single measurements

With the respective buttons you can measure distances, polylines, angles and circle radius / centres.

7.9.3 Processing > Stereo correlation (matching)

Camera definition, interior and exterior orientation of both images and the model definition must already exist. Only the actual model or all models of the block as given in the strip definition can be processed (batch mode), in the latter case they may optionally be mosaicked afterwards. The DTM to be created will have the pixel size as given in the project definition, nevertheless, the step size of the correlation may be set to a multiple of it, for instance in flat terrain.

In this module the elevations within the model area will be reconstructed. Because the orientation of each image is known, the programme can calculate corresponding pixel co-ordinates for any terrain point (x, y, z) using the collinearity equations (see figure 1 and formula 4.3.1). As mentioned before, the process works “from bottom to top” – proceeding from an initial height z_0 in a given DTM position (x, y) , the z value will be modified until the resulting image parts

(neighbourhoods of the intersection points projection ray \rightarrow image) fit ideally (*area based matching*). The criterion for this is the maximum of the correlation coefficient. By successively continuing the process over the whole area of the model a DTM is generated.

The maximum z range in [m] must be provided. This leads to a relative shift of the images which is internally limited to a maximum of ± 45 pxl. Further, a threshold value for the correlation coefficient, the correlation window size and the number of iterations must be defined. A file with object co-ordinates of terrain points (see model definition) must exist and, optionally, a file with additional vector data (for example from additional manual measurements). The following remarks concern the individual parameters:

- *Z range +/-*: Based on the given object point co-ordinates, traces are followed in the approximate DTM (see below). If, for example, the programme analyses a position 10 m to the right of a given point the altitude can be expected to be very similar there. The displacement ratio defines an adequate limit. Generally speaking, the altitude will change within a range of ± 10 m (slopes with a maximum inclination of 45 degrees); this value may however have to be altered in high mountain regions. It should nevertheless not be set unnecessarily high to maintain precision and working speed. If the approximate DTM has been generated and is then attempted to be improved, the displacement ratio defines the maximum deviation from the approximated altitude.
- *Threshold of the Correlation coefficient*: In most cases the suggested value can be maintained. The corresponding output of the model definition (see chapter 7.7.10) presents a hint to evaluate the specific situation in terms of achievable values. Except for particular cases (e.g. low contrast images) it does not make much sense to choose a value of less than 0.6 – this will cause more points to be correlated but also leads to a loss of accuracy.
- *Correlation window*: As a general rule we can say that the greater the window, the more stable and less accurate will be the results and the more time for calculation will be needed. On the other hand, small correlation windows may lead to problems in areas with repetitive structures.

The measurement of homologous points and therefore the generation of the DTM takes place in several steps and is iterative:

Start points

In a first step all primary data being available in the model area from the object co-ordinates point file will be entered into the empty DTM.

Run traces → Approximate DTM

Beginning at each individual start point, traces are followed in the eight main directions of the sky (N, NW, W, SW, S, ...). Using this method, sometimes called “region growing”, steps are made to the right (left, above, below, right above, right below, left above, left below) and beginning with the height of the last point a correlation will be attempted.

Subsequently follows part two of the trace run. In the selected number of iterations a network of lines with the distance of 16 pixel in row and column direction, beginning with the traces which already exist, will be generated. Finally, blank areas (empty pixels in the DTM) are filled by interpolation.

Improvement of the DTM

With this step for every DTM pixel a homologous point will be determined, normally using a smaller correlation window than before. This makes sure that the central perspective distortions caused by the relief will mostly be eliminated and that is why the correlation leads to considerably better results especially in areas with much relief. To exclude areas which show very little contrast the variance of each point’s environment (a so-called “interest operator”) is computed. In case of an insufficient variance the position of the DTM remains blank.

After finishing with this operation, a new approximate DTM will be interpolated by a selected number of iterations from all points established, and at all positions where the correlation failed a new approach will be started with a little smaller threshold value for the correlation coefficient. After an optional interpolation the DTM can be smoothed with a filter and, also optionally, an 8-bit image is derived from the 16-bit DTM.

To reassess the result, the following parameters are displayed and stored in the REPORT.TXT file: Number of correlated points, number of interpolated points, correlation speed given by the number of correlated points per second; each value separately for the approximate and the improved DTM.

Furthermore, concerning the optional filtering of the DTM: Please keep in mind that filtering will effect the height values especially at local minimum and maximum points. When a maximum of precision is of high importance or if it is intended to generate a significant nominal-real comparison (chapter 7.9.5) it is recommended to work without a filter. On the other hand filters have proven to be successful if subsequently contour lines should be generated on the basis of the DTM.

Note 1: For the purpose of reassessment it may be advisable to deactivate the (standard) option Interpolation of missing points. The resulting DTM will then show

gaps of different sizes, especially in areas with little contrast. In these areas points should be measured manually – compare this also with the notes in the chapter Processing > Stereo measurement (chapter 7.9.2) as well as with the following chapter.

Note 2: If all models of the block shall be processed one after the other in batch mode, the name is set automatically for each single DTM. It has the form GT_<left image, right image>.IMA (example: GT_135136.IMA). If further the option Subsequent create mosaic was activated, the programme will put all files of the type GT_*.IMA within the working directory together in a mosaic. Therefore it is a good idea to delete all files of these names before starting the stereo correlation.

Note 3: To get an idea about the quality of the elevations found by the matching process, the option Quality image may be activated. Then an additional image named QUALITY.IMA will be created with the same dimensions like the DTM. Each position (pixel) in which the correlation was successful will have a grey value calculated as 100 times the correlation co-efficient. Therefore, the grey values contained in the quality image usually ranges between 60 ($r = 0.6$) and 99 ($r = 0.99$).

7.9.4 Processing > DTM interpolation

In the case that a DTM generated by stereo correlation had shown gaps and therefore additional points were measured manually, an area-covering DTM may be interpolated with the help of this option from the initial DTM and the points measured in addition. As described above the options Filtering and Additional 8-bit image are at your disposal. The option Only model area restricts the interpolation to this area instead of going to the axis-parallel borders of the DTM.

7.9.5 Processing > Compare nominal - real

If a file with exact, three-dimensional co-ordinates of points is available, it might serve as quality control of a DTM generated by a stereo correlation (see chapter 7.9.3). The reference point file, the DTM and the output file have to be defined, which will then obtain the values for x, y and the difference of height (nominal – real; if the option List of differences is activated). Furthermore, information about the minimal / maximal deviation will be calculated and the deviations of between –20 and +20 metres will be displayed in form of a histogram (given 1 m – intervals).

In case that no display of the results will appear or the output file remains empty this means that no DTM height exists for any of the points in the input file, possibly caused by an incomplete DTM.

Note concerning the evaluation of results: The height accuracy can be interpreted by the product of the parameters *pixel size of the input images* and *distance-base ratio* which were calculated during the model definition (see chapter 7.7.13).

7.9.6 Processing > Ortho image

This feature serves the purpose of the differential full rectification of a digital image onto an underlying DTM. The rectification quality depends on the quality of the DTM! The images to be processed must be oriented entirely, and of course a DTM should exist. As an alternative it is possible to rectify to a horizontal plane (z constant).

Three options concerning the input images are available:

- Single image
- Actual model
- All images

Single image: The image number must be defined as well as the source of the exterior orientation: From BLUH or BINGO, then also their output file (default name DAPOR.DAT), or via an ABS file for example from a manual measurement of the exterior orientation (see chapter 7.7.6).

Actual model: The model definition must have been carried out already. Then, the left as well as the right image of the current model will be used in a way that those features of the image lying closer to the left image's principal point will be adopted from the left image; analogously on the right hand side (nearest nadir).

All images: Assume that a complete DTM already exists for the whole project area (for example created within the stereo correlation, options All models and Create mosaic used; see chapter 7.9.3), then with this option all oriented images within the working directory can be rectified and matched in one pass. The programme takes all oriented images from the strip definition (chapter 7.7.4) and process them one after the other. The grey value definition within the ortho image will be done in the nearest nadir mode (see above).

In case of the second or the third option, a stepless grey value adjustment between the particular images can be selected.

The rectification takes place on the area determined by the DTM which also defines the geometric resolution (pixel size) of the ortho image. In positions for which no DTM information is available (blank spaces, e.g.), the ortho image remains empty.

If the DTM is larger than the area covered by the ortho image, the latter may be limited to the relevant size (Option Only model area). This option is advisable for

example to subsequently combine single ortho images to a mosaic, especially since each image requires less memory then.

Again the indirect method “from bottom to top” is being employed: based on the DTM the corresponding grey value for every pixel of the input image will be determined from the rays reconstructed in the course of image orientation.

7.9.7 Processing > Image sequence

Preparation: This option is designed for automatic processing of image sequences (in this case stereo models photographed in a chronological order). The left image always corresponds with the same camera (position) and so does the right one. The image numbers should have 6 digits – then, the first digit refer to the camera number. Example: Image 100001 was taken from camera 1, image 200001 from camera 2. By this, the reference to the camera definition files CAMERA_1.CMR and CAMERA_2.CMR can be handled.

About how to handle this tool: Beginning with the object points of the first model and a stereo correlation is executed. Object points are derived from the resolving DTM in a regular grid to serve as start values for the model definition of the ever next model to follow. Further, using the DTM and the images of the actual model, optionally an ortho image is created.

To make the programme track the images reliably a certain numbering mode (naming) of the image files is inevitable.

Example: Provided we have got 10 models, the image files may be named as follows:

Model 1:	left image 100001.IMA, right image 200001.IMA
Model 2:	left image 100002.IMA, right image 200002.IMA
...	
Model 10:	left image 100010.IMA, right image 200010.IMA

In other words: All images have an unequivocal number, whereby the image numbers (-names) of the left and of the right camera are chosen in ascending order.

The exterior orientations of the first two images (first model) and the model definition of the first model must already exist.

Input data: Left and right image of the first model, left and right image of the last model, start points for the first model, grid width for the output of start points, used for the following models. Finally, the input window with the parameters of the stereo correlation appears (see there), the options Additional 8-bit image and Quality image are without meaning here.

By clicking the OK button, the parameters are stored in the files SEQ_FOTO.DAT and SEQ_PARAM.DAT within the working directory, and the processing of the sequence is started. The following files will be created:

- DTMs named GT_<left image, right image>, e.g. GT_10012001.IMA
- Optionally ASCII file with object points. Same name as before, but with the extension DAT.
- Optionally ortho image named OR_<left image, right image>, e.g. OR_10012001.IMA

7.10 Display

7.10.1 Display raster image

Input image: 1, 8 or 24 bit raster image (format IMA, BMP, JPG or TIF). 16 bit DTMs are converted to 8 bit internally before.

File: Open, Save, Save as, Print. Save: If the colour palette was changed, the image rotated or mirrored or the geo-codification changed, the image can be stored with this modifications. Print: Raster images may be issued using a matrix printer or raster plotter installed in the operation system. If the output size exceeds the available paper size the print will cover several sheets which must be attached manually.

Palette: Several possibilities for the modification of the image's grey values. Options: Normal, Negative (for grey value, respectively colour images), Colour 1, Colour 2, Open, 0 → black, 0 → white, Brightness, Flood, Marking.

- Option brightness: Settings for brightness and contrast.
- Option Flood: Especially useful for 8 bit images of a DTM – the area below the defined grey value will be displayed in a blue colour (8 bit).
- Option Marking: Only one grey value is displayed in green, all others in grey. Useful for example to highlight areas in an image of land use (8 bit).

The original palette can be restored using the button Reset.

View:

- Reduce / Enlarge / Move: Activates a magnify cursor or a hand shape cursor. With the left mouse button depressed, the image can then be reduced, enlarged or moved. Finish this option with Normal or the right mouse button. Independently of this, the image can be moved at any time with depressed

middle mouse key. The speed of moving can be set using the respective buttons. Further, the image detail displayed in the overview image (see below) can be moved using the left mouse key, then moving the image simultaneously.

- Turn by 90, 180 or 270 degrees, mirror left-right
- Factor: Fixed factor between 10% and 1000%
- Optimal: Maximum zoom factor in order to display the entire image
- Reset: Like when starting the module.

Overlay:

- Vector data: The superimposition's colour or grey value may be selected. Individual points may be displayed alternatively with the corresponding number, height or a dot mark (small square).

Additional:

- Display of an overview image, histogram and grey tone wedge, legend. The overview image shows the position of the part currently displayed. If the display of a legend is required it has to be generated beforehand (LISA BASIC, option Output > Create legend).
- Copy: Stores the image within the clipboard for use in other graphics programmes.
- Info image: After having chosen a file, its most important data will be displayed. An existing geo-codification can be deleted using the button Reset. The button Formal creates a "formal" geo-codification. The relation grey value → z value can also be deleted using the Reset button.

Remark: Within the LISA BASIC programme, you will find the same mono image display with several additional functions like on-screen digitising and others.

7.10.2 Display text

This is used for the creation, display, processing and printing of a text file (e.g. control points, statistical results, LISA vector data). This module is also started automatically in LISA at some places, for example after calculating statistical data of a DTM. You have editor standard options like cut / copy / paste and find / find next (F3) / replace, undo, and also the possibility to give out the file on a printer.

7.11

Aerial triangulation with BLUH

Pre-remarks: The bundle block adjustment programme BLUH (author: Dr.-Ing. Karsten Jacobsen, IPI, University of Hannover) was installed on your computer in a special version with reduced functionality. Up to now all BLUH modules normally run in a DOS window. To make the handling more easy a graphics user interface for the handling of the main modules (BLOR, BLAPP, BLIM, BLUH) and the analysis module BLAN under a MS Windows™ operating system was developed. Because of BLIM and BLUH are in fact one single programme (BLIM: input of the parameters, BLUH: the block adjustment) you will not find the term BLIM but just BLUH.

BLUH_WIN will create a parameter file for each BLUH module, then starting the particular module itself. It is no more necessary to define the path of BLUH in the environment variable section of the system – simply make sure that all BLUH modules as well as BLUH_WIN are located in the same directory.

For detailed information about the particular modules please use the programme descriptions (in c:\lisa\text or on the CD-ROM).

7.11.1 Getting started

To work with BLUH_WIN you must define projects, that means, for each of your projects you have to define a name and the working directory which contains the data. Then, with the next start of BLUH_WIN you can select in which project you want to work.

Remark: The project definition files (extension PRJ) are located in the BLUH directory and are compatible with those of LISA. Therefore, if you want to use BLUH in connection with LISA it is a good idea to install all BLUH and LISA modules within the same directory.

7.11.2 Pre processing

Most of the options located here are already known from LISA – if necessary, use the information in the respective chapters above.

7.11.3 Pre processing > Import PIX

For the import of pixel co-ordinates from the measurement tool IMATIE (extension PIX). These are stored in a single image mode (one PIX file per image) and can be imported strip-wise into the BLUH format (stereo mode), the default output name is DAPHO.DAT.

A strip definition file (STRIP.DAT) and the camera definition file(s) must exist. The pixel co-ordinates are transformed to image co-ordinates using an affine approach.

7.11.4 Block adjustment > Strategy

This is an option to help beginners setting the parameters. All you must know are some details like the approximate scale and the scan resolution (in case of analogue photos) or the approximate ground resolution and the pixel size of the sensor (in case of digital images) and some more.

Depending on the quality of the photo co-ordinates, the strip connection and the control points, several of the BLUH input parameters are set to useful values. Nevertheless, in the following modules you may change each of those parameters.

7.11.5 Block adjustment > The central BLUH modules

Pre 1 (BLOR), Pre 2 (BLAPP), Main (BLUH): See the respective BLUH manuals. The results of each module (for instance BLOR.LST) are shown in an editor window after the module has finished.

2D pre-check: Before starting BLOR, a 2D adjustment can be started to find large errors. If such errors occur they are displayed and BLOR will not be started. Please remove the wrong data, then start Pre 1 (BLOR) again. Or just de-activate the option 2D pre-check.

Parameters: Standard deviations of the image co-ordinates in [μm], transformation of the strips together in [μm], control points (separately in x / y and z) in [m]. Remarks: The value for the standard deviation of the image co-ordinates may be between 1 and 2 pixels of the input images. For instance, if the images were scanned with 600 dpi or ca. 42 μm , the value should be about 60 to 80 μm . The value for the strip connection is usually a bit higher, here for instance 100 μm . In case of images coming from a digital camera use the pixel size of the chip instead of the scan resolution. The standard deviation of the control points depends on their suggested accuracy and the ground resolution of the images.

Automatic error correction: From the file BLOR.COR, created in the pre programme BLOR, optionally an error correction list named DACOR.DAT can be created and used in the following module BLAPP. Some remarks about this:

We have to divide between errors at control points, tie points of neighbouring strips and other points. The errors are listed in BLOR.COR according to their size in relation to the defined standard deviations, then marked with asterisks from no asterisks = small error to 4 asterisks = large error. For each point group can be selected from which amount of asterisks an error correction will be carried out (for instance, errors at control points beginning with ***). Please take into account that

any automatic correction is a bit dangerous. If, for example, the limit for all groups of points will be set to the lowest value (*), then it can happen that a lot of points will be ignored in the adjustment what may have a negative influence to the strip connection and the stability of the block. Therefore it is suggested to start with the following limits: Control points ****, tie points ***, other points *. According to the fact that automatic aerial triangulation measurements (AATM, like those in LISA FOTO) usually will find a large amount of points, the value of the third point group (other points) can be set to a low value in most of these cases.

7.11.6 Block adjustment > All (batch)

Runs BLOR, BLAPP and BLUH directly one after the other. This option is useful if for instance after a previous run one or more control points were changed.

7.11.7 Block adjustment > Export orientations

The parameters of the exterior orientation, usually stored in the file DAPOR.DAT, contain the co-ordinates of the projection centres and the rotation angles. The latter ones are calculated in the order φ , ω , κ and in the units of grads. With this option the sequence of the rotation angles can be converted into ω , φ , κ , the units can be converted into degrees, radians or mils (for military purposes).

7.11.8 Post processing > Analysis (BLAN)

See the BLAN manual for details. If a plot file is created, this will be displayed automatically after BLAN has run and the results (BLAN.LST) were displayed in the editor window.

7.11.9 Post processing > Display graphics

For the display of PLT files created with BLUH. These files have the HP-GL-1 format.

Beside the standard functions you can print the graphics on the standard printer defined in the operating system. Also you can export it to the clipboard (option Copy) or into the BMP or JPG format (raster image), for instance to use the graphics in other software packages.

7.11.10 Some more theory

In the following, some more information about the BLUH modules is given. This was taken from the BLUH manuals (JACOBSEN 2007) and reduced to the options available for LISA:

BLOR: Approximate image orientations are computed by means of combined strips. The relative orientation, strip formation, transformation of strips together

and the transformation to the control points are checked for blunders by *data snooping*. BLOR also creates an image number list in a sequence which leads to a minimised band width of the reduced normal equation system of the bundle block adjustment.

The image co-ordinates of the input file are stored in a direct access file with an index corresponding to the image number. The mean values of repeated measurements are used if they are within a tolerance limit. That means, there is no restriction to the sequence of the image co-ordinates in the input file and no limitation of the number of independent data sets of an image in the input file.

Corresponding to the image numbers in the strips, neighbouring images are transformed together by a similarity transformation. The shift in x and y and the rotation are used as start values for the relative orientation. The relative orientation is not identical to the relative orientation made during data acquisition for data check because the mean values of the image co-ordinates from all data sets are used.

After the relative orientation, model co-ordinates are computed. Neighbouring models are transformed by similarity equations based on tie points in the strip. The build up strips are stored in a scratch file. The orientation of any strip is determined by the orientation of the first image in any strip. After finishing the strip creation, neighbouring strips are transformed together by a two-dimensional similarity transformation. Then the internal block system will be transformed again in two dimensions to the horizontal control points. This method for receiving approximate values for the image orientations will not lead to precise results but is sufficient as initial information for the block adjustment and is a very robust solution (see also figure 31).

BLAPP: This module is sorting the image co-ordinates in a sequence which is optimal for the bundle block adjustment. The measured image co-ordinates may exist in mono or stereo arrangement (LISA: Stereo). For the bundle block adjustment all observations for an object point have to be present at the same time. That means, the measurements have to be re-arranged by the object points. In addition the order of points shall cause a minimal bandwidth of the reduced normal equation system of the bundle block adjustment.

BLIM: This module handles all input parameters and temporarily files for the main module BLUH which is started immediately thereafter.

BLUH: This main module is a bundle block adjustment based on the collinearity equations. Observations are image co-ordinates and the control point co-ordinates. The interior orientation must be known at least approximately. Unknowns are the image orientations and the object co-ordinates. In the adjustment the square sum of the image co-ordinate corrections multiplied with the weight will be minimised. A blunder detection by robust estimators is possible. Since the

collinearity equations are not linear, Newton's method is used for iterative computation, that means, approximate values for the unknowns are required as input. The approximate image orientations usually are determined by BLOR (see above). Based on the approximate image orientations BLUH is computing in the zero iteration approximate object co-ordinates based on the image orientations and the image co-ordinates.

The blunder detection in the programme system BLUH will be done in two steps. The first search with the method of data snooping will take place in the module BLOR. The detected blunders should be corrected or eliminated before starting the bundle block adjustment – therefore it is suggested to use the option Error correction (chapter 7.11.5). The first run of a data set with BLUH should be done with blunder detection by *robust estimators*.

The robust estimators will reduce the weight of the defective observations, so finally the influence of blunders to the block adjustment is limited. The main problem in the data acquisition for block adjustment is the correct identification of tie points between neighbouring strips; within the strips the tie is usually correct. The robust estimators will reduce the weights of the observations of a strip tie point in such a case for one strip. That means, also the tie within one strip will be lost. If no re-measurement will be done, at least the point number of the observations within one strip should be changed – this will solve the discrepancy of the tie between the strips and within the strip there is still a connection.

For the blunder *identification* one more observation than for the blunder *detection* is required. In the case of a blunder in the base direction, the blunder can be detected with 3 images but three intersections are available – any can be correct. Therefore one more observation is required for the correct identification of the blunder. In the case of a blunder across the base direction with 3 observations, two will have an intersection, so the blunder can be identified.

Even with robust estimators not all blunders can be detected in one programme run if large and smaller blunders are mixed because large blunders can cause deformations of the block which will not be eliminated totally during iteration with robust estimators. If the control points are used with large standard deviations during adjustment with robust estimators, the block geometry can get too weak, so the number of iterations should be limited to 2. With error free control points a larger number of iterations with robust estimators is possible. If numerical problems are occurring, the block adjustment should be repeated with a smaller number of iterations with robust estimators.

To enable a simple analysis of errors in control points, the control points are computed at first as tie points, after this as horizontal control points (marked by CP in the output list) and finally as vertical control points (marked by CZ). If no image co-ordinate corrections are listed for the tie point but for the horizontal or vertical control point, the geometric problems are caused by the ground co-ordi-

nates or the identification in any image. If image co-ordinate corrections are listed also with approximately the same size for the control point used only as tie point, the problems are caused by some image co-ordinate measurements.

In the case of error free control points, the ground co-ordinates of the control points are used without change. But there can be also differences in the image co-ordinates of the control points. For this reason, an intersection based on the adjusted image orientations will not lead to the input values of the control points. So also in this case there are differences between the original control point co-ordinates and the computed ground co-ordinates of the control points.

Appendix

1. Codes

The meaning of point and line data is defined in LISA by the parameter code:

1 – 3000	general single points
3001 – 3100	like before, with raster symbol (file with extension SIG)
3501 – 3600	like before, with vector symbol
4001 – 5000	for DTMs, in particular:
4006	significant single points, filter resistant
4007	starting points for deletion of free cut areas
5001 – 8000	general lines
8501 – 8600	like before, with vector symbol
9001 – 9999	for DTMs, in particular:
9007	limits for interpolation
9008	border polygon for free cut areas
9009	„soft“ break line, if needed will be filtered
9010	„hard“ break line, filter resistant

For details see the LISA BASIC manual (c:\lisa\text\lisa.doc).

2. GCP positions for tutorial 2

On the following pages you find all of the models used in tutorial 2 (chapter 5), giving you the possibility to find the approximate positions of the GCPs.

The models are arranged in the order in which they forms the block, from left to right within each strip.

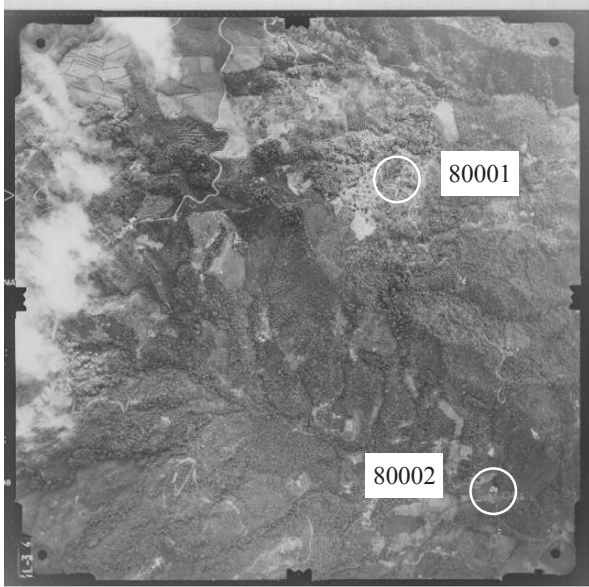

Model 134 / 135

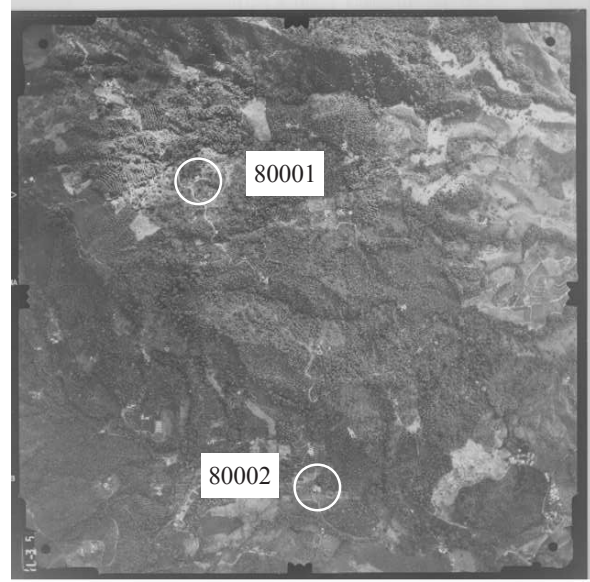

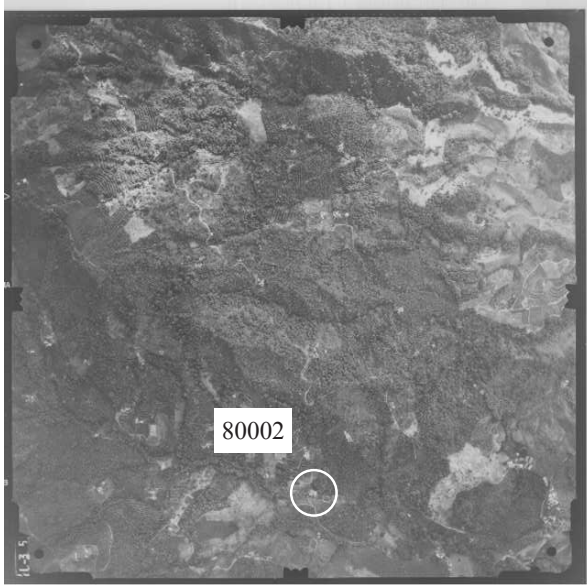

Model 135 / 136

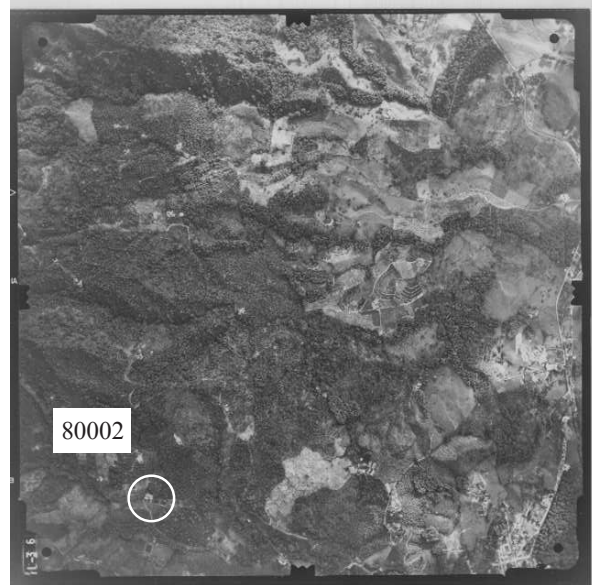

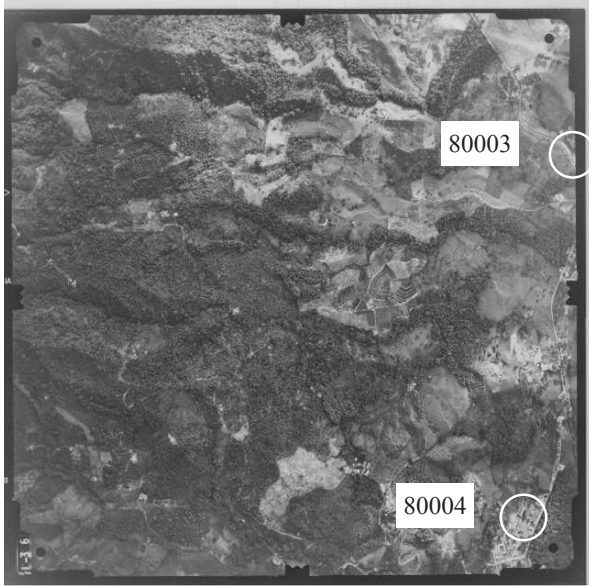

Model 136 / 137

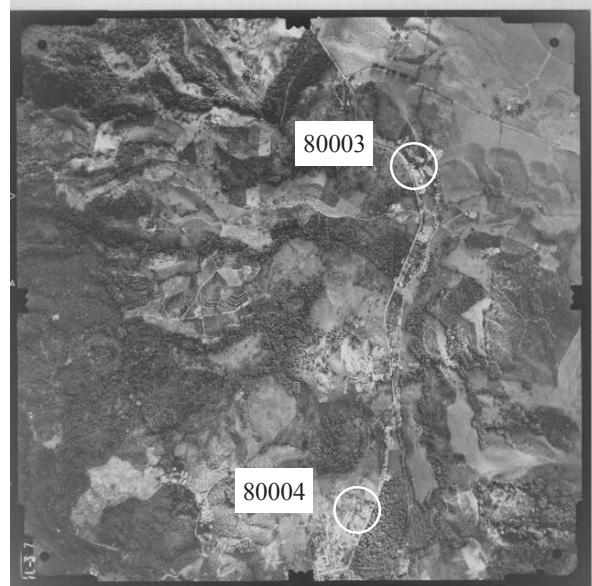

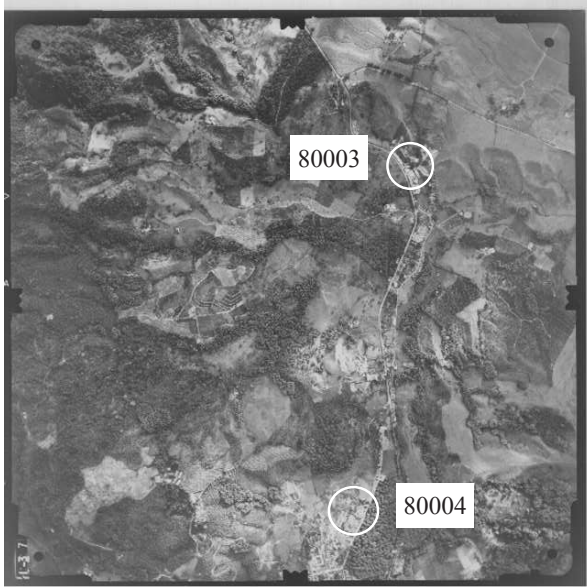

Model 137 / 138

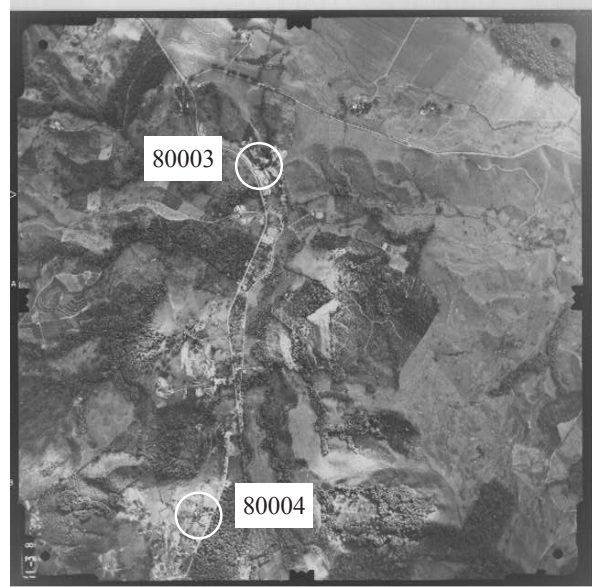

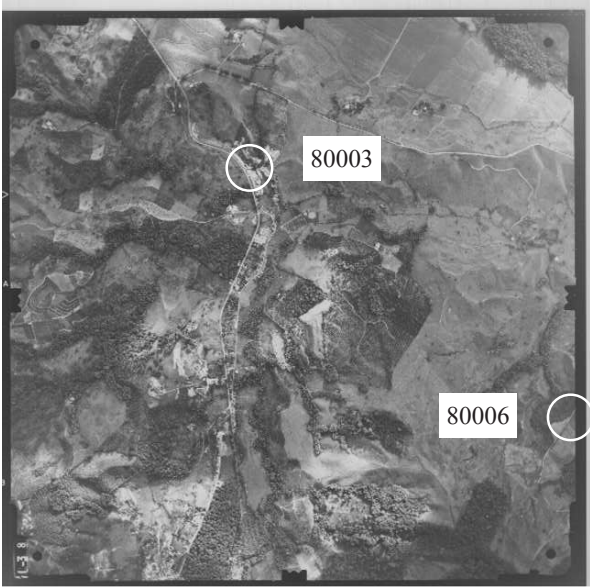

Model 138 / 139

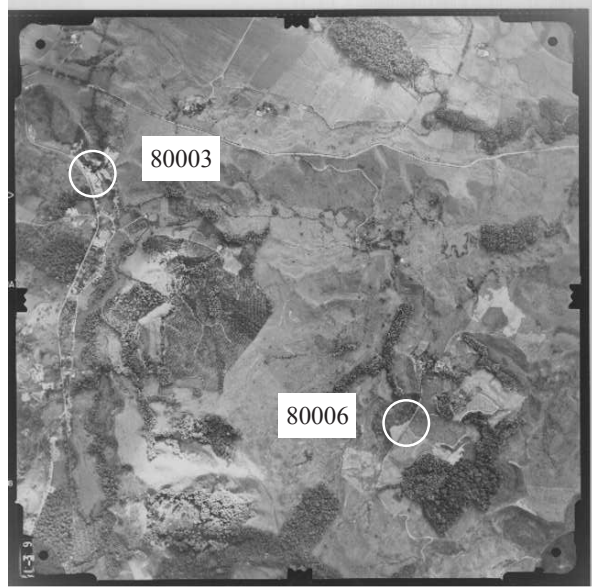

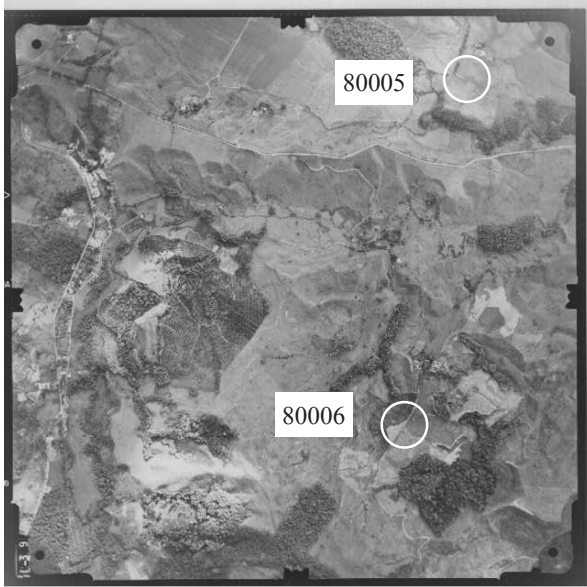

Model 139 / 140

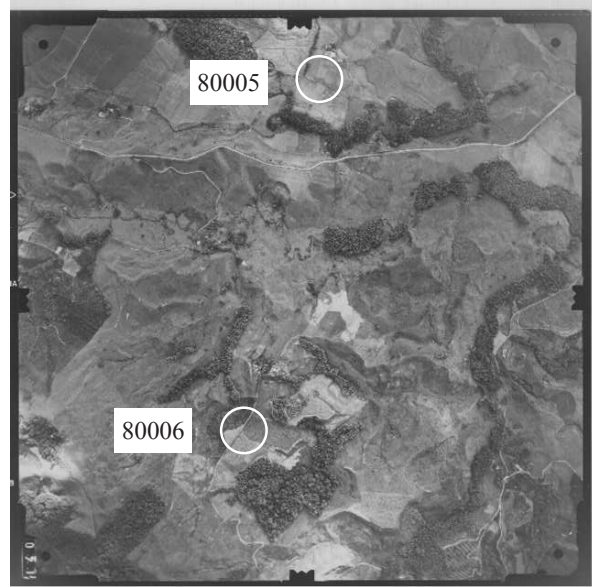

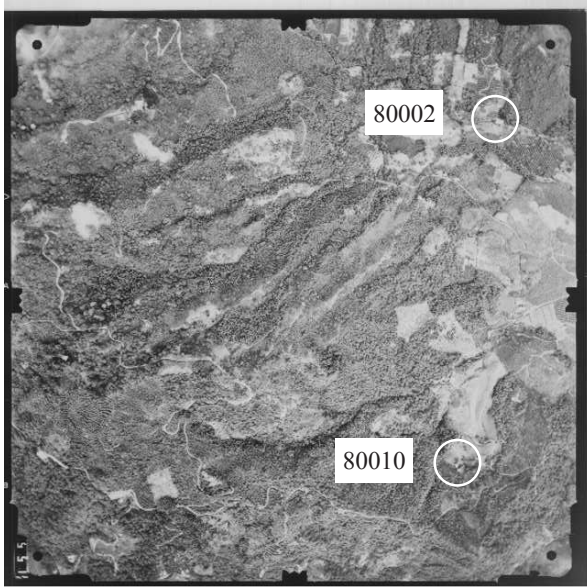

Model 155 / 156

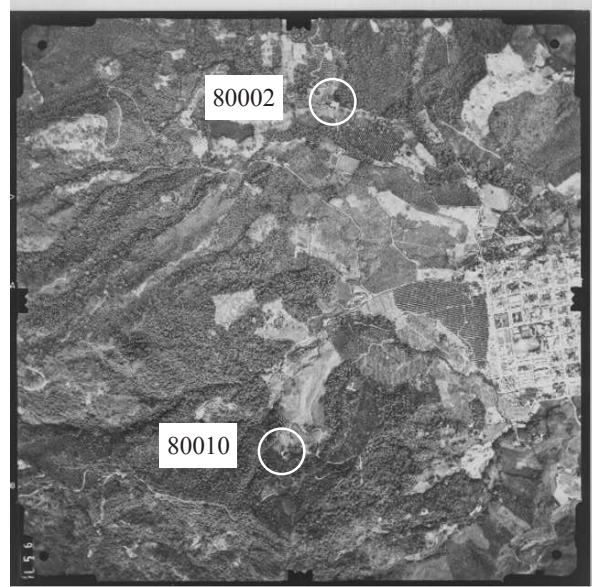

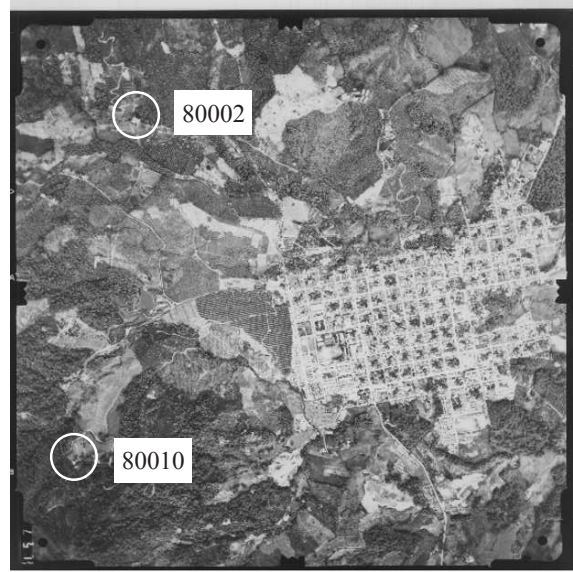
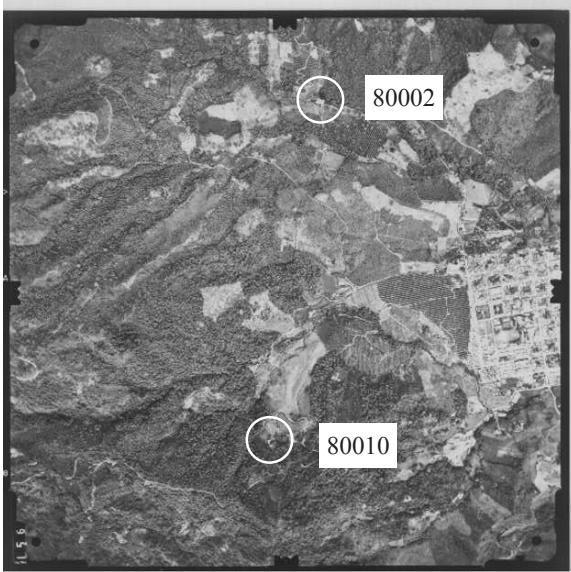

Model 156 / 157

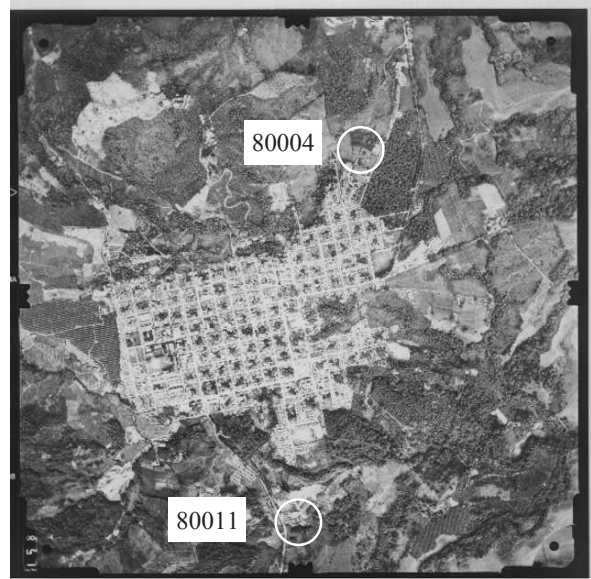
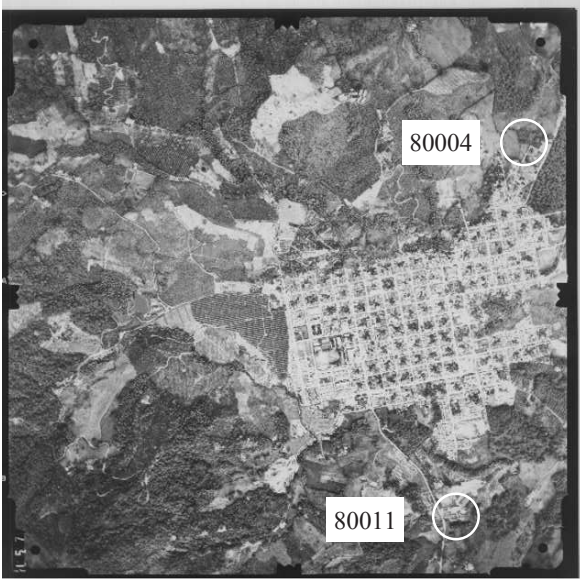

Model 157 / 158

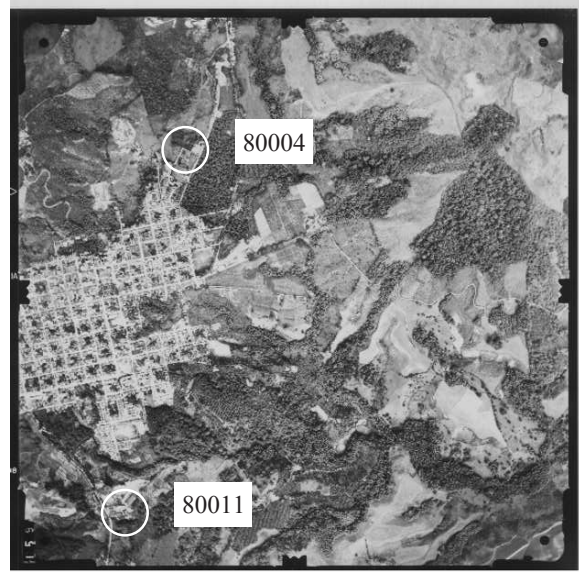
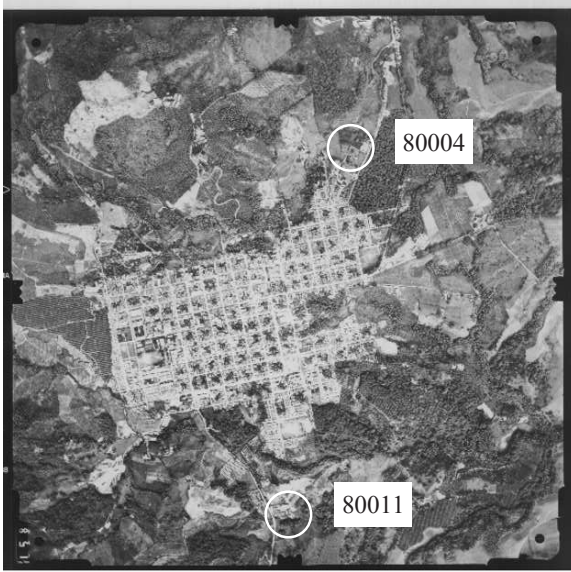

Model 158 / 159

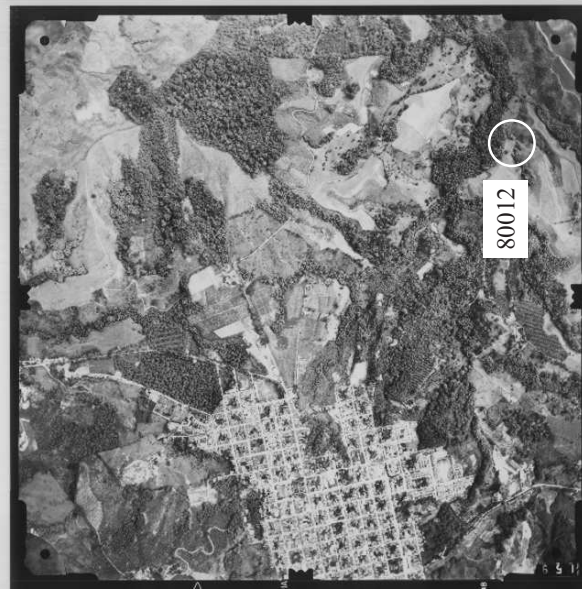
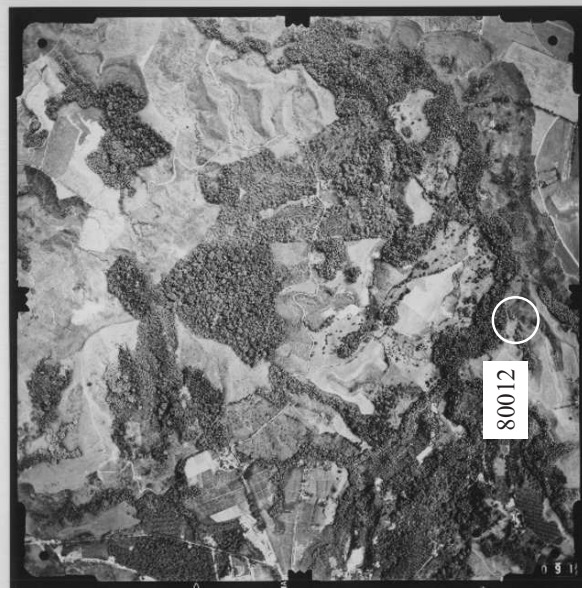

Model 159 / 160

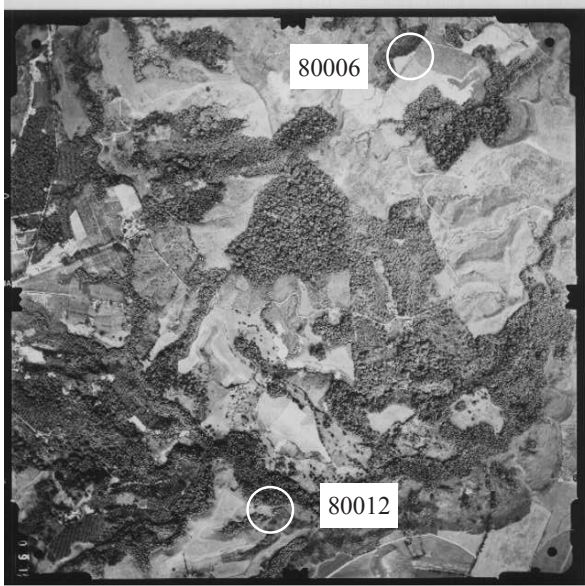

Model 160 / 161

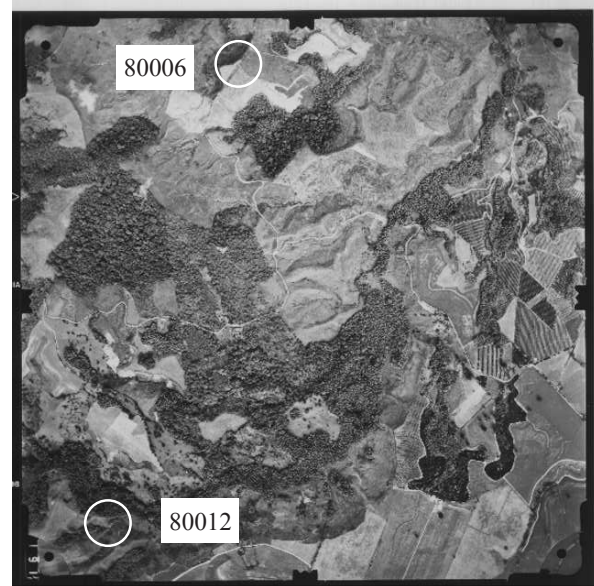

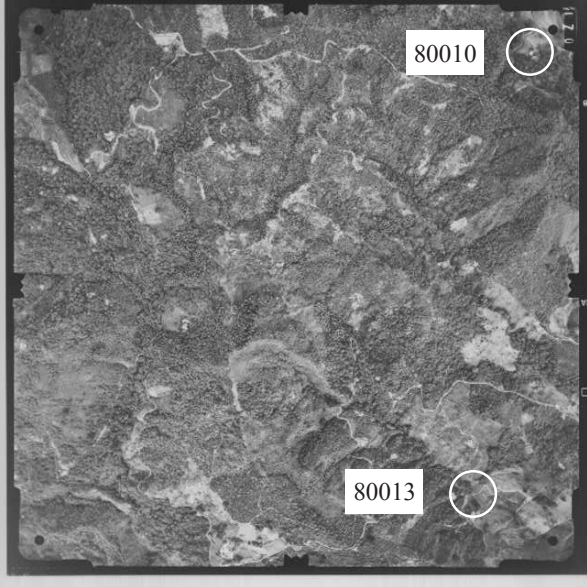

Model 170 / 169

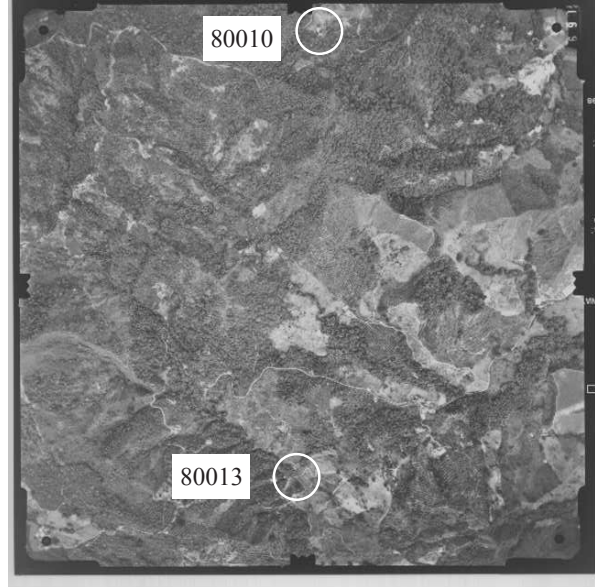

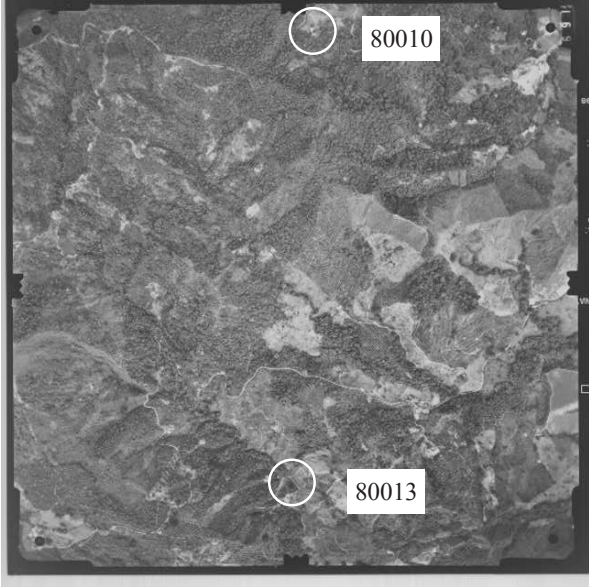

Model 169 / 168

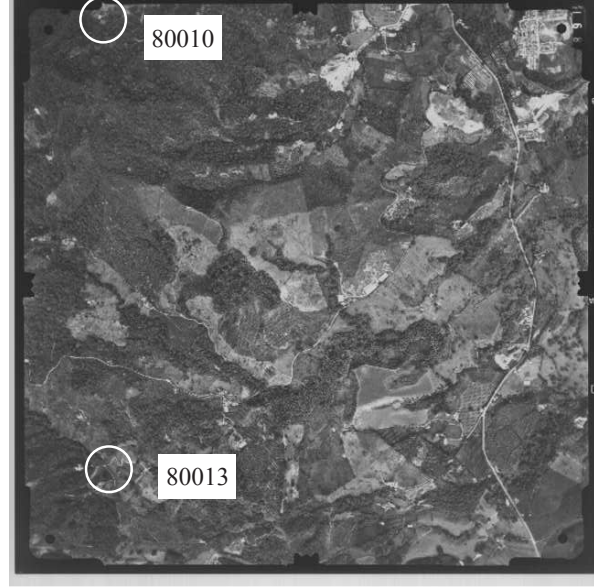

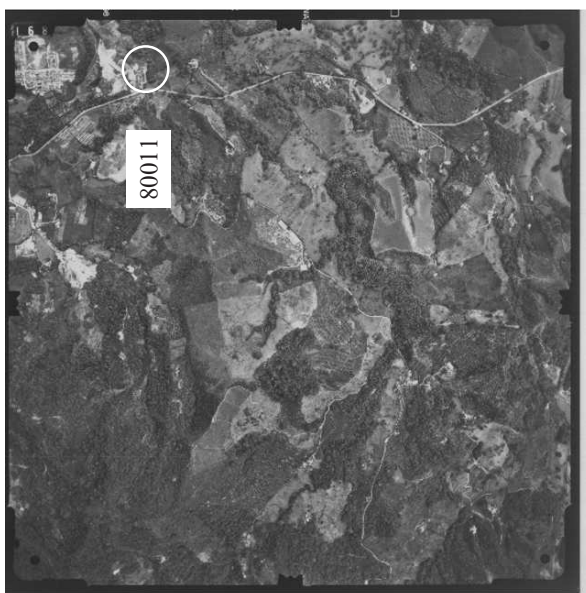
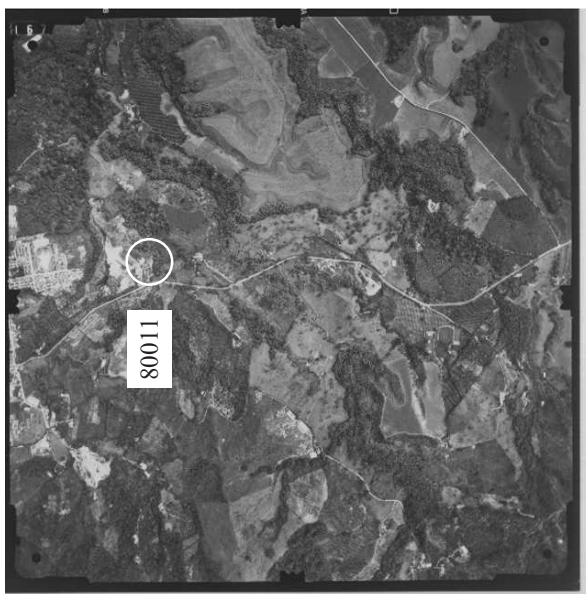

Model 168 / 167



Model 167 / 166



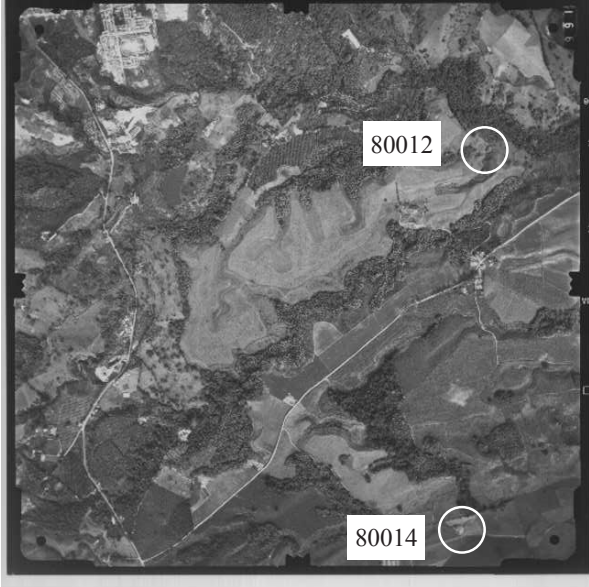

Model 166 / 165

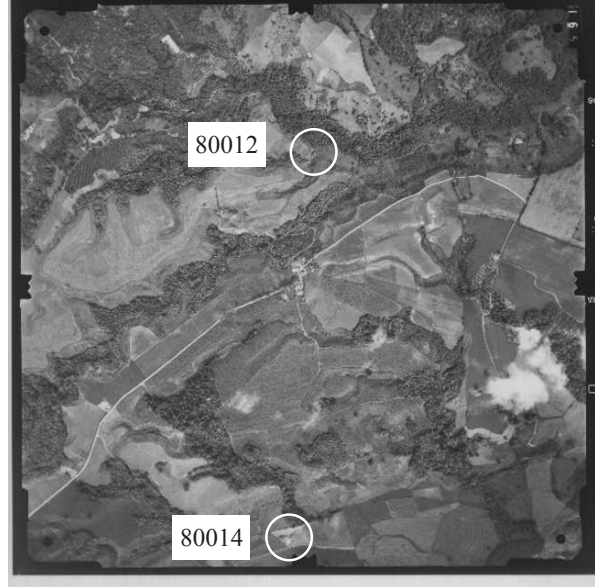

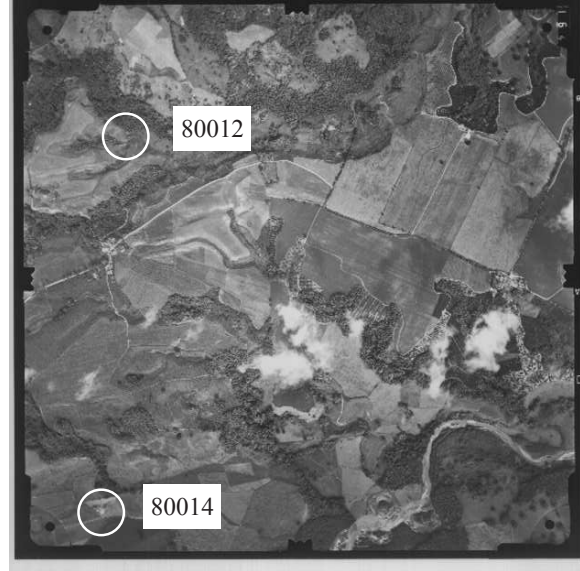
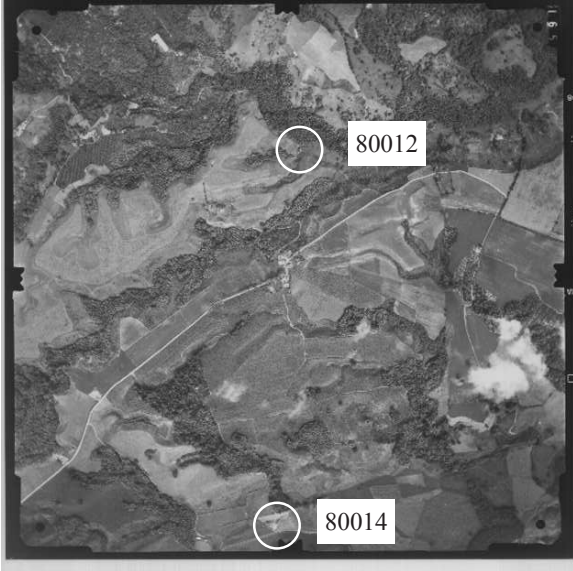

Model 165 / 164

3. Technical data of digital camera chips

Chip size (nominal)	Diagon.	Width	Height	No. of pixel	Pixel size [μm]
	[mm]	[mm]	[mm]		
1/3.6"	5.0	4.0	3.0	1280 x 960	3.2
1/3.2"	5.7	4.5	3.4	1620 x 1220	2.8
1/3"	6.0	4.8	3.6		
1/2.7"	6.6	5.3	4.0	2048 x 1536	2.6
1/2.5"	7.1	5.7	4.2	2288 x 1712	2.5
1/2.4"	7.4	5.9	4.4	2592 x 1944	2.3
1/2"	8.0	6.4	4.8	1280 x 1024	6.0
...				1280 x 1024	5.0
1/1.8"	8.93	7.2	5.3	2048 x 1536	3.45
...				2080 x 1542	3.45
...				2592 x 1944	2.8
...				2272 x 1704	3.1
1/1.7"	9.5	7.6	5.6	2048 x 1536	3.7
2/3"	11.0	8.8	6.6	2560 x 1920	3.4
...	11.0	8.8	6.6	3264 x 2448	2.6
1"	16.0	12.8	9.6		
4/3"	22.5	18.0	13.5	2614 x 1966	6.8
...	21.8	17.4	13.1	2560 x 1920	6.8
-		20.7	13.8	2268 x 1512	9.13
-	27.3	22.7	15.1	3072 x 2048	7.4
-	42.6	35.8	23.1	4064 x 2704	8.8
-		36	24	4536 x 3024	7.9
-	34.5	28.7	19.1	2464 x 1648	11.6

See the camera's manual for the nominal chip size (say 1/2,7") and the resolution, then use the table to find the pixel size. If in the manual instead of the nominal chip size the border lengths (width and height in mm) of the chip are given you can directly calculate the pixel size:

$$\text{Pixel size } [\mu\text{m}] = \frac{\text{width} \times 1000}{\text{No. of columns}} = \frac{\text{height} \times 1000}{\text{No. of rows}}$$

References

- Albertz, J. & Wiggenhagen, M. (2005): Photogrammetrisches Taschenbuch / Photogrammetric Guide. 5th edition Heidelberg, 292p.
- Bacher, U. (1998): Experimental Studies into Automatic DTM Generation on the DPW770. *Int. Arch. of Photogrammetry and Remote Sensing*, Vol. 32, Part 4, pp 35-41.
- Baltsavias, P.B. & Waegli, B. (1996): Quality analysis and calibration of DTP scanners. *IAPRS*, Vol. 31, Part B1, pp 13-19.
- Behan, A. & Moss, R. (2006): Close-Range Photogrammetric Measurement and 3D Modelling for Irish Medieval Architectural Studies. The 7th International Symposium on Virtual Reality, Archaeology and Cultural Heritage. Project presentations.
- Brown, D. C. (1971) : Close range camera calibration. *Photogrammetric Engineering*, Vol. 8, pp 855-866.
- Büyüksalih, G. & Li, Z. (2003) : Practical experiences with automatic aerial triangulation using different software packages. *Photogrammetric Record*, Vol. 18, pp 131-155.
- De Lange, N. (2002) : *Geoinformatik in Theorie und Praxis*. Heidelberg, Berlin, New York. 438 S.
- Frick, W. (1995): Digitale Stereoauswertung mit der ImageStation. *Zeitschrift für Photogrammetrie und Fernerkundung*, H. 1, S. 23-29.
- Grodecki, J. (2001): Ikonos Stereo Feature Extraction - RPC Approach. ASPRS annual convention St Louis.
- Hannah, M.J. (1988): Digital stereo image matching techniques. *International Archives of Photogrammetry and Remote Sensing*, Vol. 27, Part B3, p 280-293.
- Hannah, M.J. (1989): A system for digital stereo image matching. *Photogrammetric Engineering and Remote Sensing*, Vol. 55, No. 12, pp 1765-1770.
- Heipke C., (1990): Integration von digitaler Bildzuordnung, Punktbestimmung, Oberflächenrekonstruktion und Orthoprojektion innerhalb der digitalen Photogrammetrie, DGK-C 366, Beck'sche Verlagsbuchhandlung, München, 89 p (PhD thesis).
- Heipke, C. (1995): State-of-the-art of Digital Photogrammetric Workstations for Topographic Applications. *Photogrammetric Engineering and Remote Sensing*, Vol. 61, pp 49-56.
- Heipke C., (1995): Digitale photogrammetrische Arbeitsstationen, DGK-C 450, Beck'sche Verlagsbuchhandlung, München, 111 p.
- Heipke, C. (1996): Overview of Image Matching Techniques. In Kölbl O. (Ed.), *OEEPE - Workshop on the Application of Digital Photogrammetric Workstations*, OEEPE Official Publications No. 33, 173-189.
- Heipke, C. (2004): Some requirements for Geographic Information Systems: A photogrammetric point of view. *Photogrammetric Engineering and Remote Sensing*, Vol. 70, No. 2, pp 185-195
- Heipke, C. & Eder, K. (1998): Performance of tie-point extraction in automatic aerial triangulation. *OEEPE Official Publication No. 35*, Vol. 12, pp 125-185.
- Helava, U.V. (1988): Object-space least squares correlation. *Photogrammetric Engineering & Remote Sensing*, Vol. 54, No. 6, pp 711-714.
- Hobrough, G.L. (1978): Digital online correlation. *Bildmessung und Luftbildwesen*, Heft 3, pp 79-86.

- Jacobsen, K. (2000): Erstellung digitaler Orthophotos. GTZ Workshop zur Errichtung eines Kompetenznetzwerks für die Sicherung von Grundstücksrechten, Land- und Geodatenmanagement. Hannover, 8 S.
- Jacobsen, K. (2001): New Developments in Digital Elevation Modelling. *GeoInformatics* No. 4, pp 18 - 21.
- Jacobsen, K. (2001): PC-Based Digital Photogrammetry, UN/Cospar ESA-Workshop on Data Analysis and Image Processing Techniques, Damascus, 2001, volume 13 of "Seminars of the UN Programme of Space Applications", selected Papers from Activities Held in 2001, 11p.
- Jacobsen, K. (2006): Understanding Geo-Information from High-Resolution Optical Satellites. *GIS Development Asia Pacifica*, S. 24-28.
- Jacobsen, K. (2007): Programme manuals BLUH, RAPORIO and RPCDEM. Institute for Photogrammetry and GeoInformations, University of Hannover.
- Jacobsen, K. (2007): Comparison of Image Orientation by Ikonos, QuickBird and OrbView-3. *EARSeL*. "New Developments and Challenges in Remote Sensing". Rotterdam, S. 667-676.
- Jordan / Eggert / Kneissl (1972): *Handbuch der Vermessungskunde* Bd. IIIa / 2. § 104 - 108.
- Jayachandran, M. (2003): DEM accuracy in analytical and digital photogrammetry. *GIS Development*, Vol. 3, pp 33-38.
- Kaufmann, V. & Ladstaedter, R. (2002): Spatio-temporal analysis of the dynamic behaviour of the Hohebenkar rock glaciers (Oetztal Alps, Austria) by means of digital photogrammetric methods. *Grazer Schriften der Geographie und Raumforschung*, Bd. 37, S. 119-140.
- Keating, T. J. (2003): Photogrammetry goes digital. *GIS Development*, Vol. 3, pp 29-31.
- Konecny, G. (1978): Digitale Prozessoren für Differentialverzerrung und Bildkorrelation. *Bildmessung und Luftbildwesen*, H. 3, S. 99-109.
- Konecny, G. (1984): *Photogrammetrie*. 4. Auflage, Berlin, New York, 392 p.
- Konecny, G. (1994): New Trends in Technology, and their Application - Photogrammetry and Remote Sensing - From Analogue to Digital. 13th United Nations Cartographic Conference, Beijing, China, May 9-18, 1994 (World Cartography).
- Konecny, G. (2002): *Geoinformation*. Taylor & Francis, London, 247 p.
- Konecny, G. & Pape, D. (1980): Correlation techniques and devices. Vortrag zum XIV. ISP-Kongress Hamburg. IPI Universität Hannover, Heft 6, pp 11-28. Also in: *Photogrammetric Engineering and Remote Sensing*, 1981, p.323-333
- Kruck, E. (2003): Programme manual BINGO. GIP, Aalen.
- Leberl, F. & Gruber, M. (2003): Aerial film photogrammetry coming to an end: Large format aerial digital camera. *GIM International*, Vol. 17, No. 6, pp 12-15.
- Linder, W. (1991): Klimatisch und eruptionsbedingte Eismassenverluste am Nevado del Ruiz, Kolumbien, während der letzten 50 Jahre. Eine Untersuchung auf der Basis digitaler Höhenmodelle. *Wiss. Arb. d. Fachr. Vermessungswesen d. Univ. Hannover*, Nr. 173, 125 S. und Kartenteil.
- Linder, W. & Meuser, H.-F. (1993): Automatic and interactive tiepointing. In: *SAR Geocoding: Data and Systems*. Karlsruhe. p 207-212.
- Linder, W. (1994): Interpolation und Auswertung digitaler Geländemodelle mit Methoden der digitalen Bildverarbeitung. *Wiss. Arb. d. Fachr. Vermessungswesen d. Univ. Hannover*, Nr. 198, 101 S.
- Linder, W. (1999): *Geo-Informationssysteme – ein Studien- und Arbeitsbuch*. Heidelberg, Berlin, New York. 170 S.
- Linder, W. & Heins, B. (2005): Nahbereichsphotogrammetrie mit handelsüblichen Digitalkameras. In Luhmann, T. (Hg.): *Photogrammetrie, Laserscanning, Optische 3D-Messtechnik*. Oldenburg. S. 142-148
- Lohmann, P. (2002): Segmentation and Filtering of Laser Scanner Digital Surface Models, Proc. of ISPRS Commission II Symposium on Integrated Systems for Spatial Data Production, Custodian and Decision Support, IAPRS, Volume XXXIV, part 2, pp. 311-315.
- MapTEC (2004): Photogrammetric evaluations with usual digital cameras – specified for the programme LISA. See http://www.maptec.de, cam_guide.pdf

- Masry, S.E. (1974): Digital correlation principles. *Photogrammetric Engineering* Vol. 3, pp 303-308.
- Mayr, W. (2002): New exploitation methods and their relevance for traditional and modern imaging sensors. Vortrag zur 22. Wissenschaftlich-technischen Jahrestagung der DGPF, Neubrandenburg.
- Miller, S.B., Helava, U.V. & De Venecia, K. (1992): Softcopy photogrammetric workstations. *Photogrammetric Engineering & Remote Sensing*, Vol. 58, pp 77-84.
- Miller, S.B. & Walker, A.S. (1995): Die Entwicklung der digitalen photogrammetrischen Systeme von Leica und Helava. *Zeitschrift für Photogrammetrie und Fernerkundung*, H. 1, S. 4-15.
- Mustaffar, M. & Mitchell, H.L. (2001): Improving area-based matching by using surface gradients in the pixel co-ordinate transformation. *ISPRS Journal of Photogrammetry & Remote Sensing*, Vol. 56, pp 42-52.
- Petrie, G. (2003): Airborne digital frame cameras – the technology is really improved! *GeoInformatics*, Vol. 6, No. 7, pp18-27.
- Petrie, G., Toutin, T., Rammali, H. & Lanchon, C. (2001) : Chromo-Stereoscopy : 3D Stereo with orthoimages and DEM data. *GeoInformatics*, No. 7, pp 8-11.
- Plugers, P. (2000): Product Survey on Digital Photogrammetric Workstations. *GIM International*, Vol. 7, pp 76-81.
- Reulke, R. (2003): Design and application of high resolution imaging systems. *GIS* Vol. 3, pp 30-37.
- Rieke-Zapp, D., Wegmann, H., Nearing, M. & Santel, F. (2001): Digital Photogrammetry for Measuring Soil Surface Roughness, In: Proceedings of the year 2001 annual conference of the American Society for Photogrammetry & Remote Sensing ASPRS, April 23-27 2001, St. Louis.
- Rollmann, W. (1853): Zwei neue stereoskopische Methoden. *Annalen der Physik*, vol. 166, Issue 9, pp.186-187.
- Ruzgiene, B. (2007): Comparison between Digital Photogrammetric Systems. *Geodezija ir Kartografija*, Vol. 33, Nr. 3, pp 75 - 79
- Santel, F. (2001): Digitale Nahbereichsphotogrammetrie zur Erstellung von Oberflächenmodellen für Bodenerosionsversuche. Diplomarbeit, Universität Hannover, 119 S.
- Santel, F., Heipke, C., Könnecke, S. & Wegmann, H. (2002): Image sequence matching for the determination of three-dimensional wave surfaces. Proceedings of the ISPRS Commission V Symposium, Corfu. Vol. XXXIV, part 5, pp 596-600.
- Sasse, V. (1994): Beiträge zur digitalen Entzerrung auf Grund von Oberflächenrekonstruktion. *Wiss. Arb. d. Fachr. Vermessungswesen d. Univ. Hannover*, Nr. 199, 227 p.
- Schenk, T. (1999): *Digital Photogrammetry*, Volume I. Terra Science, Laurelville, 428 p.
- Schenk, T. & Krupnik, A. (1996): Ein Verfahren zur hierarchischen Mehrfachbildzuordnung im Objektraum. *Zeitschrift für Photogrammetrie und Fernerkundung*, H. 1, S. 2-11.
- Schneider, C., Schnirch, M., Casassa, C., Acuña, C. & Kilian, R. (2007): Glacier inventory of the Gran Campo Nevado Ice Cap in the Southern Andes and glacier changes observed during recent decades. *Global and Planetary Change*, Vol. 59, pp 87 - 100.
- Spoerl, H. (1933): *Die Feuerzangenbowle*. Düsseldorf.
- Usery, E. L. (1993): Virtual stereo display techniques for three-dimensional geographic data. *Photogrammetric Engineering and Remote Sensing*, No. 12. pp 1737-1744.
- Walker, A.S. & Petrie, G. (1996): Digital Photogrammetric Workstations 1992-96. ISPRS congress Vienna. *International Archives of Photogrammetry and Remote Sensing*, Vol. XXXI, part B2, pp 384 – 395.
- Wegmann, H., Rieke-Zapp, D. & Santel, F. (2001): Digitale Nahbereichsphotogrammetrie zur Erstellung von Oberflächenmodellen für Bodenerosionsversuche. *Publikationen der DGPF*, Band 9 , Berlin.
- Wiggenhagen, M. (2001): Geometrische und radiometrische Eigenschaften des Scanners Vexcel UltraScan 5000. *Photogrammetrie, Fernerkundung, Geoinformation* H. 1, pp 33-37.

- Willkomm, P. & Dörstel, C. (1995): Digitaler Stereoplotter PHODIS ST – Workstation Design und Automatisierung photogrammetrischer Arbeitsgänge. Zeitschrift für Photogrammetrie und Fernerkundung, H. 1, S. 16-23.
- Wundram, D. & Löffler, J. (2007): Kite Aerial Photography in High Mountain Ecosystem Research. Grazer Schriften der Geographie und Raumforschung, Band 43, S. 15 – 22.
- Wrobel, B. & Ehlers, M. (1980): Digitale Korrelation von Fernerkundungsbildern aus Wattgebieten. Bildmessung und Luftbildwesen Nr. 48, S. 67-79.
- Zhang, B. & Miller, S. (1997): Adaptive Automatic Terrain Extraction. Proceedings SPIE Vol. 3072, pp 27-36.

Glossary

Anaglyphs: Method of optical separation of the left and the right image for stereo viewing. Uses base colours as filters (red – green, red – blue or red – cyan). The images are displayed / printed overlaid, each in one of the base colour, and can then be viewed with a special spectacle

Base: In Photogrammetry the distance between the projections centres of the left and the right image. See also → Height-base ratio

Block: All images covering an area and being processed in a block adjustment, usually located in → strips

Calibration: Method to calculate geometric or radiometric errors (distortions) of cameras or scanners. The results of a calibration can then be used to correct these errors

CCD: Charge Coupled Device. Light-sensitive elements arranged in a line or in an area, used in digital cameras and scanners

Certain points: → Homologous points where the correlation was successful. These points are used for a correction of the y → parallaxes

Control points: Points with known → object co-ordinates which can be found in an image, then used for instance to calculate the exterior → orientation

Correlation co-efficient: Measure of similarity, used to compare two samples of data. The absolute value ranges between 0 (totally different) and 1 (identical)

DPI: Dots Per Inch. Unit of geometric resolution of scanners, printers and other equipment. 1 inch = 2.54 cm

DSM: Digital Surface Model. Describes the real heights of all objects (terrain, houses, trees, ...)

DTM: Digital Terrain Model: Describes only the terrain heights (without artificial objects)

Epipolar plane: Defined by the projection centres of the left and the right image and the actual position on the object. Changing the height of the object will lead to a movement of the corresponding points in the images along epipolar lines

Fiducial marks: In analogue → metric cameras used for the reconstruction of the interior → orientation of the photos. The marks define the → image co-ordinate system

Focal length: Distance between the projection centre and the film plane (or the → CCD chip) of a camera, defines the opening angle

Frame camera: Equipped with film or a → CCD area sensor. These cameras have a central perspective in contrary to systems with a line sensor

GCP: Ground Control Point. See also → control points

Height-base ratio: In aerial photogrammetry relation between the flying height above ground and the → base; equivalent in close-range photogrammetry is the ration distance/base. The value has a direct influence to the attainable accuracy of the calculated intersection of projection rays

Homologous points: Object points which are located in two or more images from different positions. May be detected using the maximum of the → correlation coefficient

Image: Here used for digital raster graphics, coming from a digital camera or a scanner

Image pyramids: Set of images with decreasing resolution, used in image matching

Image space, image co-ordinates: Two-dimensional co-ordinates measured in the images, units [mm]. In analogue cameras / photos the image co-ordinate system is defined by the → fiducial marks

Metric camera: Camera with very high optical and mechanical precision, usually with fixed focal length, calibrated

Model: In photogrammetry a pair of images taken from different positions. Also called stereo model

Nadir photo: Aerial photo from a camera looking exactly down or in other words, the rotation angles ϕ and ω both have the value zero. Opposite: Oblique photos

Object space, object co-ordinates: The terrain (aerial case) or in general the object(s) from which the images were taken. The co-ordinate system may be a

“world system” like Gauss-Krueger or UTM but also can be a local one. Usually the co-ordinate axes are rectangular to another and the co-ordinates are given in metric units.

Orientation: The interior o. defines the relation between the camera and the image and can be calculated in the analogue case using the fiducial marks. The exterior o. defines the relation between the image and the → object space. Parameters of the exterior o. are the co-ordinates of the projection centre and the rotation angles

Parallaxes : Co-ordinate differences of an object point in neighbouring images. The x parallax is a result from the camera positions and the relief, the y parallax is zero in an ideal case and should be corrected if not

Photo: Here used for analogue images on film or paper in contrary to the digital representation (→ image)

Pixel co-ordinates: Pixel position of a point in rows and columns, counting from the upper left corner of a (digital) image

Radial-symmetric displacement: Relief-dependent displacements of objects in the image taken by a central perspective camera

Resampling: Recalculation of grey values or colours in image processing. For instance necessary when an image shall be rectified

Residuals: Remaining errors at → control points after an adjustment

Resolution: The geometric r. is equal to the pixel size, the radiometric r. is equal to the number of grey tones or colours of an image

Stereoscopic viewing: An image pair can be viewed stereoscopical (in a special manner) if the left image is only viewed by the left eye, the right image only by the right eye. One of several methods to achieve this are → anaglyphs

Strip: In aerial photogrammetry all photos taken one after another in the same flight line

Surface model: See → DSM

Terrain model: See → DTM

Tie points: Within an aerial triangulation used to connect models and strips

List of figures and formulas

1. Figures

- Fig. 1: Geometry in an oriented stereo model. Changing the height in point P (on the surface) leads to a linear motion (left – right) of the points P' and P'' within the photos along epipolar lines.
- Fig. 2: The DMC (Digital Mapping Camera) – an example of a digital aerial camera. Left: Camera mounted on carrier. Right: View from below – you can see the lenses belonging to the four area sensors. Courtesy of Intergraph Corp., USA.
- Fig. 3: Example of metric digital cameras: The medium-format AIC (left) and the small-scale d7 metric (right) from Rollei. Courtesy of Rollei Fototechnic, Germany.
- Fig. 4: Photos taken from different positions and with different lens angles. The Situation, view from above.
- Fig. 5: The results: Photos showing the house in same size but in different representations due to the central perspective.
- Fig. 6: Focal length, projection centre and rotation angles.
- Fig. 7: Relations between focal length f , height above ground h_g and the photo scale f/h_g .
- Fig. 8: Camera positions parallel (above) and convergent (below).
- Fig. 9: Photos, models and strips forming a block.
- Fig. 10: A typical workflow
- Fig. 11: Flatbed DTP scanner and suggested positions of the photos.
- Fig. 12: All photos of a block should be scanned in the orientation in which they form the block, regardless to the flight direction.
- Fig. 13: Shapes (first and second row) and positions (third row) of fiducial marks in aerial photos.
- Fig. 14: Result of automatic centring of a fiducial mark.
- Fig. 15: Relations between grey values in the image and on screen.
- Fig. 16: Examples of natural ground control points.
- Fig. 17: Positions of the control points in the left image (157)
- Fig. 18: Positions of the control points in the right image (158)
- Fig. 19: Calculated versus correct graph of the function $f(x) = ax + b$ using two, three or more observations.
- Fig. 20: Test image, model 157 / 158, showing the relative position of the images and the positions of the control points.

- Fig. 21: Situation in the terrain and kinds of digital elevation models.
- Fig. 22: Relation between image positions and correlation coefficient.
- Fig. 23: Parts of the left and the right image, strongly zoomed. The grey values are similar but not identical. Therefore, the correlation coefficient will not be equal but near to 1.
- Fig. 24: Displacements caused by the relief, grey value differences from reflections. Area: Nevado de Santa Isabel, Colombia.
- Fig. 25: DTM derived from image matching.
- Fig. 26: Central projection (images) and parallel projection (map, ortho image).
- Fig. 27: The resampling problem: Find the grey values for the pixels in the new image.
- Fig. 28: Effect of the grey value adjustment.
- Fig. 29: Ortho image, 10-m contours overlaid.
- Fig. 30: Proposed positions of control points in the block. From JACOBSEN, 2007.
- Fig. 31: Scheme of a block adjustment.
- Fig. 32: Principles of point transfer within a block.
- Fig. 33: Position and terrain co-ordinates of the control points.
- Fig. 34: Part of the graphics interface for the measurement of strip connections.
- Fig. 35: Automatic search of connection points (tie points) starting with already measured points
- Fig. 36: Workflow and interchange files in BLUH. Simplified from JACOBSEN, 2007.
- Fig. 37: Results from BLUH - Distribution of control and tie points.
- Fig. 38: Results from BLUH - Area covered by each image.
- Fig. 39: DTM mosaic, 25 m contours overlaid
- Fig. 40: Ortho image mosaic
- Fig. 41: Ortho image mosaic draped over the DTM mosaic.
- Fig. 42: Scan of an aerial photo on an A4 DTP scanner.
- Fig. 43: Test field for soil erosion, a camera position, control points. From SANTEL, 2001.
- Fig. 44: Schematic drafts of points with good contrast. Left: Suitable for all purposes. Middle: Suitable only for y parallax correction. Right: Suitable only for measurement of the x parallax (\rightarrow height)
- Fig. 45: Situation before rain (left) and afterwards (middle), 10 m contours overlaid, differential DTM (right).
- Fig. 46: The test area (above) and the camera positions on top of two houses (below). From SANTEL et al., 2002
- Fig. 47: Approximate positions of the control points.
- Fig. 48: Positions of the control points in detail.
- Fig. 49: Points found by correlation, showing the wave structures. The cameras are looking from bottom right.
- Fig. 50: Wave movement, time interval 0.25 seconds.
- Fig. 51: Effects of lens distortion. Above: Focal length 5.7 mm (wide angle), barrel-shaped distortions. Below: Focal length 24.5 mm, very few distortions.
- Fig. 52: Barrel-shaped (left) and pincushion-shaped (right) distortions.

Fig. 53: Radial-symmetric lens distortions modelled by a third-order polynomial.

Fig. 54: Geometry of stereo images from satellites. From JACOBSEN, 2007.

Fig. 55: Geometry of flatbed scanners.

In the appendix: Stereo models and ground control point positions (for tutorial 2).

2. Formulas

- 1.7.1 Relation between height above ground, focal length and photo scale
- 1.10.1 Length units
- 1.10.2 Angle units
- 3.2.1 Relation between pixel size [dpi] and geometric resolution [μm]
- 3.3.1 Grey value calculated from an RGB image
- 4.2.3.1 Brightness and contrast
- 4.3.1 Collinearity equations
- 4.3.2 Co-ordinate transformations
- 6.6.1 Rational polynomial coefficients (RPCs)

Index

- AATM, 87, 89–91, 97, 98, 104, 149, 163, 165, 166
- ABM, 57
- absolute orientation, 39, 95, 141
- accuracy, 5, 13, 14, 27–29, 37, 38, 41, 43, 49, 50, 62, 64, 65, 67, 73, 82, 93, 97, 111, 117, 142, 154, 157, 171, 174, 179, 206, 210
- aerial camera, 4, 20, 213
- aerial triangulation, 16, 21, 39, 76, 82, 91, 149, 159, 164, 180, 205, 211
- aerial triangulation, 21, 75, 149, 159, 178
- anaglyph method, 53, 73, 143, 160
- Analogue, 4, 7, 36, 52, 147, 206
- analysis, 64, 91, 99, 178, 182, 205, 206
- analytical plotter, 7, 11, 29
- anchor points, 60, 67
- Angle, 27
- approximation, 88, 165
- area sensor, 5, 133, 210
- ASCII, 43, 72, 81, 99, 144, 169, 177
- azimuth, 109
- base, 1, 14, 15, 21, 28, 33, 42, 43, 49, 50, 52, 71, 108, 119, 144, 169, 174, 182, 209, 210
- batch mode, 31, 105, 145, 146, 156, 170, 173
- bilinear, 68, 69
- block, 15, 16, 21, 29, 31, 75–79, 82, 85, 89–92, 94, 97, 99, 104, 105, 109, 130, 142, 149, 156, 159, 163–166, 170, 173, 178, 180–182, 185, 209, 213, 214
- Block adjustment, 91, 104
- blunders, 91, 93, 95, 181, 182
- BMP, 29–31, 111, 145
- border, 34, 41, 48, 52, 53, 54, 63, 67, 88, 111, 114, 117, 127, 156, 157, 165, 185, 204
- break lines, 53, 157, 185
- brightness, 38–40, 59, 69, 86, 150, 160, 163, 176
- calibration, V, 6, 30, 35, 36, 91, 113, 114, 117, 133, 134, 147, 148, 150, 154, 205, 209
- camera, 35, 36, 116, 123, 147, 148, 154, 165, 168, 170
- camera definition, 35, 36, 116, 123, 147, 148, 154, 165, 168, 170
- cartesian, 115
- CCD, 7, 27, 29, 50, 111, 116, 117, 209, 210
- CD-ROM, III, IV, 19–24, 29, 44, 49, 78, 85, 87, 109, 116
- central perspective, 1, 5, 7, 8, 10, 51, 65, 172, 210, 211, 213
- central projection, 66, 214
- certain points, 49, 50, 118, 119, 156, 157, 158
- close-range, IV, V, 3, 5, 91, 111, 121, 140
- code, 21, 54, 72, 122, 127, 169, 185
- collinearity equations, 45, 49, 53, 91, 170, 181, 182, 215
- connection points, 75, 88–90, 101, 155, 159, 163, 164, 165, 166, 214
- contours, 21, 41, 70, 71, 106, 108, 109, 120, 214
- contrast, 14, 38, 39, 40, 59, 61, 62, 73, 88, 118, 119, 121, 127, 129,

- 149, 150, 152, 164, 165, 171–173, 176, 214, 215
- control point, 40, 42, 43, 149
- Correction, 118
- correlation, 60, 62, 127, 160, 206
- correlation coefficient, 49, 57–62, 64, 65, 88, 118, 127, 158, 160, 165, 168, 171, 172, 210, 214
- correlation window, 60–62, 88, 127, 165, 171, 172
- cubic convolution, 69
- data collection, 72
- data reduction, 71, 91
- data snooping, 93, 181, 182
- differential DTM, 116, 119, 120, 121
- digital camera, 6, 7, 15, 20, 50, 114, 116, 126, 147, 152, 157, 179, 204, 206, 210
- digitising, 53, 152
- displacements, 8, 9, 59, 65, 133, 171, 211, 214
- DSM, 57, 65, 67, 70
- DTM, 21, 53, 55, 56, 60–67, 69–73, 82, 105, 106, 108–110, 116–121, 123, 127, 129, 130, 141, 144, 156, 157, 168–177, 205, 209, 211, 214
- end lap, 15, 29, 80, 88, 159
- epipolar, 2, 50, 53, 58, 127, 210, 213
- equidistance, 71, 108
- Error, 95, 98, 158, 182
- error correction, 93, 95, 96, 98–100, 179
- export, 72, 104, 162, 166, 167, 169
- exterior orientation, 11, 39, 41, 43, 44, 48, 75, 90, 91, 105, 116, 118, 123, 124, 126, 141, 149, 152, 155, 156, 158, 159, 168, 170, 174, 180
- feature collection, 51, 53
- fiducial marks, 27, 29, 35, 36, 37, 38, 50, 111, 113, 146–148, 150, 151, 154, 156, 162, 166, 167, 210, 211, 213
- filter, 69, 70, 108, 160, 172, 185
- filtering, 70, 71, 108, 119, 127, 172, 173, 206
- focal length, 4, 6–8, 11–13, 35, 36, 45, 49, 113, 116, 133, 147, 148, 151, 153–155, 162, 210, 213, 215
- format, 27, 149
- frame camera, 210
- gaps, 61, 62, 63, 67, 69, 169, 173
- Gauss-Krueger, 11, 115
- Gauß-Krüger, 11, 211
- GCP, 41, 43, 45, 76, 124
- generalisation, 41, 42
- geometric resolution, 5, 28, 34, 68, 144, 157, 174, 209, 215
- GPS, 42, 65, 139
- grey value, 29, 64, 69, 106
- grey value adjustment, 69, 70, 174, 106, 214
- grid, 54, 62, 63, 109, 162, 165, 169, 175
- ground control points, 41, 42, 65, 75, 76, 78, 82, 91, 213
- Gruber points, 78, 80, 81, 161
- height-base ratio, 14, 49, 157, 174
- hidden areas, 67, 121, 123
- homologous points, 82, 117, 118, 146, 171
- Image co-ordinates, 163
- image processing, 20, 55, 141, 211
- image pyramids, 90, 112, 146, 165
- image space*, 58
- import, 29, 31, 104, 145, 146, 166
- improvement, 37, 60, 80, 88, 97, 104, 129, 151, 154, 165, 172
- initial DTM, 173
- interior accuracy, 64
- interior orientation, 11, 30, 35, 37, 39, 44, 45, 76, 78, 113, 114, 116, 147, 148, 150, 152, 154, 158, 159, 162, 165, 181
- interpolation, 55, 60, 62, 63, 67, 119, 151, 169, 172, 173, 185, 206
- intersection, 3, 13, 50, 53, 58, 67, 69, 154, 171, 182, 183, 210
- JPG 28, 29, 109, 136, 143, 174, 178
- lateral overlap, 15, 163
- least squares, 48, 151, 152, 205
- lens angle, 8, 67

- line sensor, 5, 210
 longitudinal overlap, 15, 80,
 159, 165
 matching, IV, 3, 55, 57, 58, 61, 62,
 64, 73, 82, 108, 120, 112, 117,
 118, 121, 129, 156, 169, 170, 171,
 173, 205, 207, 210, 214
 Measure, 37, 38, 44, 45, 54, 63,
 72, 80, 81, 85, 86, 113, 124,
 127, 148, 150, 152, 154, 156,
 162, 163, 169
 measuring mark, 37, 38, 45, 113,
 142, 143, 150–152
 measuring marks, 53, 55, 64, 160, 170
 metric camera, 111
 metric cameras, 4, 210
 Model, 15, 48, 105, 118, 127, 158
 model area, 48–50, 54, 55, 61, 64,
 69, 117, 141, 147, 157, 158, 168,
 170, 171, 173
 model definition, 39, 105, 108, 118,
 119, 127, 141, 157, 168, 170, 171,
 174, 175
 mosaic, 69, 76, 105, 106, 107, 108,
 109, 110, 173, 174, 175, 214
 nearest nadir, 67, 69, 174
 nearest neighbour, 68
 nominal co-ordinates, 35, 36, 147,
 151, 154, 166, 167
 object co-ordinates, 48, 118, 127
 object space, 53, 58
 oblique images, 123, 127
 on-screen digitising, 41, 177
 orientation, 35, 37, 44, 113, 124,
 148, 150, 152, 154, 156, 158
 ortho image, 21, 65, 69, 71, 106,
 110, 174, 175, 214
 over-determination, 39, 41, 46,
 48, 152
 overlay, 62, 63, 65, 70, 71, 108, 169,
 170, 177
 parallax correction, 50, 117, 118,
 129, 141, 156, 157, 214
 parallaxes, 49, 50, 95, 117, 118,
 119, 127, 156, 160, 165, 209
 parallel projection, 8, 66, 214
 Pixel co-ordinates, 162
 pixel size, 6, 28, 34, 49, 60, 75, 93,
 100, 116, 119, 126, 144, 148, 153,
 157, 167, 168, 170, 174, 179, 204,
 211, 215
 plane affine transformation, 38, 39,
 50, 65, 151, 166, 167
 Point number, 159
 point transfer, 79–82, 161, 214
 pre-positioning, 38, 45, 55, 63, 118,
 150, 161, 169, 170
 principal point, 36, 116, 123, 133,
 134, 148, 174
 Project, 33, 144, 145
 projection centre, 11, 12, 44, 49, 50,
 67, 123, 124, 139, 153, 155, 210,
 211, 213
 projection rays, 8, 14, 50, 58, 65, 67,
 123, 210
 quality control, 64, 173
 quality image, 62, 64, 173
 quicklook, 81, 152
 radial-symmetric displacements, 9
 radiometric resolution, 27, 29
 Raster image, 109, 130, 176
 rectification, 65, 67, 174
reference matrix, 58
 region growing, 172
 relative orientation, 39, 91, 95,
 141, 180, 181
 repetitive structures, 59, 123,
 127, 171
 resampling, 67, 68, 69, 214
 resection in space, 45, 75, 149,
 152, 156
 residuals, 39, 45, 47, 48, 94, 97, 98,
 124, 151, 152, 153
 resolution, 4–7, 16, 19, 27–29, 32,
 39, 45, 49, 50, 59, 60, 75, 90, 93,
 97, 100, 113, 119, 123, 126, 139,
 142, 144, 145, 151, 153, 154, 164,
 179, 204, 207, 210
 roaming, 21, 160, 168
 robust estimators, 181, 182
 rotation angles, 11, 12, 123, 139,
 153, 155, 180, 210, 211, 213

- RPCs 134, 135, 203, 204, 212
- satellite 5, 8, 9, 19, 20, 132, 133, 134, 136, 137, 204, 212
- scanner, 3, 8, 11, 19, 20, 27, 29, 30, 50, 111, 112, 142, 145, 146, 147, 150, 154, 210, 213, 214, 206
- search matrix, 58, 59
- shaded relief, 108
- side information bar, 27, 29, 30, 36, 37, 113, 146, 150
- side lap, 15, 161, 163
- sigma naught, 95
- signalised points, 75
- sketch, 43, 45, 152, 163, 169
- standard deviation, 39, 45, 64, 87, 95, 97, 124, 126, 149, 153, 179
- Statistics, 64
- stereo correlation, 60, 62, 67, 70, 105, 118, 119, 127, 129, 157, 158, 169, 170, 173–175
- stereo measurement, 62, 63, 72, 73, 80, 127, 157, 170
- Stereo measurement, 24, 52, 62, 64, 117, 118, 158, 168, 173
- stereographic projection*, 65
- stereoscopic viewing*, 2, 16, 19, 51, 65
- Strip, 15, 82, 85, 94, 149
- strip connection, 87–89, 93, 98, 100, 164, 165, 179, 180
- strip connections, 82, 86, 89, 214
- subpixel improvement, 113, 150, 154
- superimposition, 170, 177
- systematic image errors, 91
- Terrain, 53, 70, 71, 106, 108, 109, 120, 130, 208
- terrain model, 52, 53, 55, 56, 70, 71, 106, 108, 109, 120, 130
- Three-dimensional, 169
- threshold value, 88, 127, 156, 158, 165, 171, 172
- tie points, 75, 86, 88, 93, 94, 99, 101, 102, 104, 159, 163, 167, 179, 181, 182, 214
- TIFF, 30, 31, 111, 145
- trace, 88, 172
- traces, 171, 172
- true-colour 30
- Triangulation, 87
- unknowns, 91, 181, 182
- UTM, 11, 115
- vector data, 60, 63, 127, 171, 177, 108, 170
- vector overlay, 109
- wide angle, 4, 36, 67, 113, 121, 132, 133, 214
- window size, 49, 62, 71, 118
- working directory, 33, 144
- zoom, 4, 6, 80, 133, 160, 177